

Description

The X7 series is outdoor NFC adjustable LED driver that operates in constant current with high PF value and universal input voltage range 90~305Vac. Adaption with wireless programming via Near Field Communication (NFC). The X7 series also provide multiple isolated dimming controls, Dim-to-Off and Always-On Auxiliary Power. It also helps clients to improve the management of logistics and stock. The compact metal case and high efficiency enable the driver to operate with high reliability, It provides extreme durability with an IP67 rating and extending product lifetime. Overall protection is provided against lightning surge, output over voltage, short circuit and over temperature to ensure low failure rate.



Product Features

- Universal input voltage / Full range: 90~305Vac;
- Constant power design, output current NFC adjustable;
- 3-in-1 dimmable: 0~10Vdc / PWM / Res. Dim-to-off;
- Auxiliary output: 12V 250mA;
- Standby Power: <0.5W;
- Output and Dimming Signal Isolating;
- Surge protection: 6KV line-line, 10KV line-earth;
- Protections: SCP / OVP / OTP;
- IP67 design for indoor and outdoor applications;
- Suitable for dry / damp / wet locations;
- 5 years warranty;

Application

Roadway lighting
Industrial lighting
Landscape Lighting
Horticulture Lighting

Models

| Model Number | Input Voltage Range (Vac) | Max Output Power (W) | Output Voltage Range (Vdc) | Full Power Output Current Range (A) | Default Current(A) | Eff. (Typ.) | PF(Typ.) | THD(Typ.) |
|---------------|---------------------------|----------------------|----------------------------|-------------------------------------|--------------------|-------------|----------|-----------|
| X7-200M286A12 | 120-277 | 200 | 143-286 | 0.70-1.05 | 0.7 | 93% | 0.97 | 5% |

Notes:

- [1]. M means 0-10V/PWM dimming.
[2]. A12 means Auxiliary source.
[3]. All specifications are measured at 25°C ambient temperature, input voltage 230Vac, and the typical value tested at full load, if no specific note.

Input Specifications

| Parameter | Min | Typ. | Max | Notes |
|---------------------------------|--------|------------|---------|---|
| Input Voltage Range | 90Vac | - | 305Vac | |
| Full Power Work Range | 120Vac | 230/277Vac | 277Vac | Refer to Output Power vs. Input Voltage curve. |
| Input Frequency AC | 47Hz | 50/60Hz | 63Hz | |
| Max Input Current | - | - | 2.5A | 100Vac & 100% load. |
| Max Input Power | - | - | 240W | 100Vac & 100% load. |
| Leakage Current | - | - | 0.70mA | IEC 60598-1;240Vac/60Hz. |
| Leakage Current | - | - | 0.75MIU | UL 8750;277Vac/60Hz. |
| Inrush Current | - | - | 75A | 230Vac, 100% load. |
| Standby Power Consumption | - | - | 0.5W | 230Vac, dimming off and auxiliary source without load |
| Power Factor (PF) | 0.95 | 0.97 | - | 100-240Vac, 50-60Hz, 70%-100% load. |
| Power Factor (PF) | 0.92 | 0.95 | - | 277Vac, 50-60Hz, 70%-100% load. |
| Total Harmonic Distortion (THD) | - | 10% | 15% | 100-240Vac, 50-60Hz, 70%-100% load. |
| Total Harmonic Distortion (THD) | - | 10% | 15% | 277Vac, 50-60Hz, 70%-100% load. |
| MCB(B16) | - | 3 | - | 230Vac; 100% load. |

Output Specifications

| Parameter | Min | Typ. | Max | Notes |
|-------------------------------------|---------------|-------|----------------|---|
| Output Voltage Range | 143Vdc | - | 286Vdc | The full power cannot be lower than 191Vdc. |
| NO-Load Output Voltage | - | - | 320Vdc | |
| Output Current Range | 70% I_{set} | - | 100% I_{set} | Adjustable current range with NFC, I_{set} is set to the full power range. |
| Full Power Current Range | 0.70A | - | 1.05A | |
| Current Accuracy | -5% | - | +5% | |
| Total Output Current Ripple (pk-pk) | - | 10% | 15% | 20MHz BW full load & LED load the LED load ripple is slightly different for different LEDs. |
| Startup Overshoot Current | - | - | 10% | 100-277Vac full load condition, LED load. |
| Auxiliary Source Output Voltage | 11.04V | 12.0V | 12.96V | 277Vac & Auxiliary source with full load. |
| Auxiliary Source Output Current | - | - | 250mA | |
| Line Regulation | -3% | - | +3% | 25°C ± 10°C ambient temperature, input changes from 176Vac to 264Vac. |
| Load Regulation | -3% | - | +3% | Load varies from 70% to 100% with 230Vac Input at 25°C ± 10°C ambient temperature. |
| Turn-on Delay Time | - | - | 1.0s | 120Vac, 25°C ± 10°C ambient temperature. |
| Turn-on Delay Time | - | - | 1.0s | 230Vac, 25°C ± 10°C ambient temperature. |

General Specifications

| Parameter | Min | Typ. | Max | Notes |
|--------------------------------|--|-----------|-------|--|
| Efficiency@120Vac Io=1.05A | 88% | 90% | - | 100% load, No load of auxiliary source. |
| Efficiency@120Vac Io=0.70A | 89% | 91% | - | 100% load, No load of auxiliary source. |
| Efficiency@230Vac Io=1.05A | 90% | 92% | - | 100% load, No load of auxiliary source. |
| Efficiency@230Vac Io=0.70A | 91% | 93% | - | 100% load, No load of auxiliary source. |
| Efficiency@277Vac Io=1.05A | 90% | 92% | - | 100% load, No load of auxiliary source. |
| Efficiency@277Vac Io=0.70A | 91% | 93% | - | 100% load, No load of auxiliary source. |
| Mean Time Between Failure | - | 200Khours | - | 25°C±10°C ambient temperature, 230Vac, 80% load condition (MIL-HDBK-217F/SR-332). |
| Lifetime | - | 50Khours | - | 230Vac & 100% load, Tc 75°C, refer to lifetime vs. case temperature curve. |
| Operating Temperature Ta | -40°C | - | +45°C | 100-200Vac, refer to Output Power vs. Ambient Temperature curve. |
| Operating Temperature Ta | -40°C | - | +50°C | 200-277Vac, refer to Output Power vs. Ambient Temperature curve. |
| Operating Tc for Safety Tc_s | -40°C | - | +90°C | |
| Operating Tc for Warranty Tc_w | -40°C | - | +75°C | 5-year warranty shell temperature, humidity: 10% to 95% RH. |
| Storage Temperature Ta | -40°C | - | +85°C | Humidity: 5% to 100% RH. |
| Altitude | -60m | - | 4000m | |
| Input Under Voltage Protection | 50Vac | 75Vac | 90Vac | Turn off the output or hiccup when the input voltage falls below protection voltage. |
| Over Temperature Protection Tc | - | 95°C | - | Decreases output current, returning to normal after over temperature is removed. |
| Short Circuit Protection | - | - | - | Hiccup mode. The output shall return to normal when the fault condition is removed. |
| Dimensions (L*W*H) | 198.5*72*39mm | | | |
| Net Weight | 930±100g/PCS | | | |
| Package(L*W*H) | 575*375*204mm;18PCS/Ctn, Gross Weight:19.2Kg | | | For reference only |

Dimming

| Parameter | Min | Typ. | Max | Notes |
|-------------------------------|----------------------|-------|-----------------------|--|
| Absolute Maximum Voltage | -10V | 10V | 20V | On the Vdim (+) Pin. |
| Source Current on Vdim (+)Pin | 90uA | 100uA | 110uA | |
| Dimming Range | 10% I _{set} | - | 100% I _{set} | I _{set} is set to the full power range. |
| Suggest Dimming Input 0-10V | 0V | - | 10V | |
| Turn-on Voltage | 0.9V | - | 1.2V | |
| Turn-off Voltage | 0.6V | - | 0.9V | |
| PWM in High Level | 9.7V | - | 10.3V | |
| PWM in Low Level | 0V | - | 0.3V | |
| PWM in Frequency Range | 500Hz | - | 2KHz | |
| PWM in Duty Cycle | 1% | - | 99% | |
| Turn-on Duty Cycle | - | - | - | |
| Turn-Off Duty Cycle | - | - | - | |
| Resistor Dimming | - | - | - | 100KΩ. |

Safety Specification

| | | | | |
|--------------------------------------|------|---------|------|---|
| Dielectric Strength (Input-Output) | - | 3750Vac | - | 60s, Current not exceeding 5mA. |
| Dielectric Strength (Input-Ground) | - | 1600Vac | - | 60s, Current not exceeding 5mA. |
| Dielectric Strength (Output-Ground) | - | 1600Vac | - | 60s, Current not exceeding 5mA. |
| Dielectric Strength (Input-Dimming) | - | 3750Vac | - | 60s, Current not exceeding 5mA. |
| Dielectric Strength (Dimming-Ground) | - | 500Vac | - | 60s, Current not exceeding 5mA. |
| Grounding Resistance | - | - | 0.1Ω | 25°C±10°C Ambient Temperature, pass 25A Current, 60s. |
| Insulation Resistance | 10MΩ | - | - | Input-Output, Input-PE, Output-PE, 500Vdc/60s/25°C. |

Safety Compliance

| Safety Category | Standards | Approved | Notes |
|-----------------|----------------------------------|----------|-------|
| CCC | GB19510.1,GB19510.14 | ✓ | |
| CE | EN61347-1, EN61347-2-13, EN62493 | ✓ | |
| ENEC | EN61347-1, EN61347-2-13, EN62384 | ✓ | |
| CB | IEC61347-1, IEC61347-2-13 | ✓ | |
| BIS | IS 15885(PART 2/SEC 13) | | |
| UL | UL 8750 | ✓ | |
| CUL | CSA C22.2 No.250.13 | ✓ | |
| KC | K61347-1, K61347-2-13 | | |
| PSE | J61347-1, J61347-2-13 | | |
| SAA | AS/NZS IEC 61347.2.13 | | |
| SAA | AS/NZS 61347.1 | | |

EMC Compliance

| EMC Category | Standards | Approved | Notes |
|----------------------|----------------------------|----------|-------|
| CCC | GB/T 17743, GB 17625.1 | ✓ | |
| CE | EN 55015 | ✓ | |
| CE | EN 61000-3-2, EN 61000-3-3 | ✓ | |
| CE | EN61000-4-2,3,4,5,6,11 | ✓ | |
| CE | EN 61547 | ✓ | |
| KC | K61547 | | |
| KC | K00015 | | |
| PSE | J55015 | | |
| FCC | FCC part 15 | ✓ | |
| Surge Shock Immunity | ANSI/C82.77-5-2017 | | |
| Ringing Wave | | | |

RoHS

Our products comply with RoHS Directive (EU) 2015/863 amending Annex II to Directive 2011/65/EU.

Inrush Current

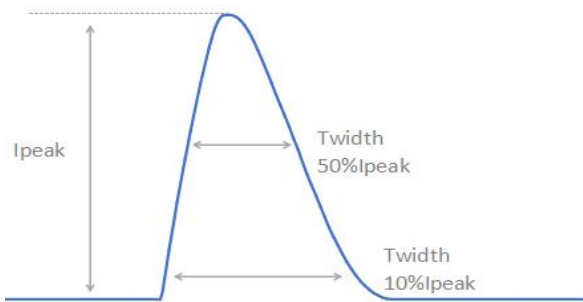

| V _{in} | I _{peak} | T(@10% of I _{peak}) | T(@50% of I _{peak}) |
|-----------------|-------------------|-------------------------------|-------------------------------|
| 120Vac | 34.0A | 836μs | 140μs |
| 230Vac | 39.5A | 1000μs | 424μs |
| 277Vac | 54.0A | 896μs | 428μs |

Output Voltage vs. Output Current

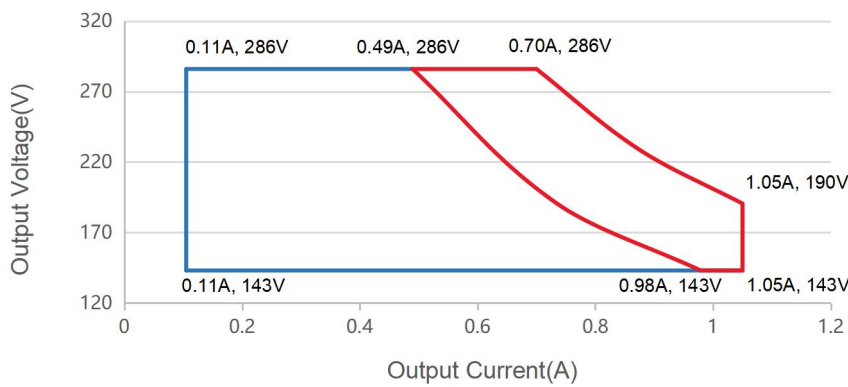

Red curve: good performance area.

Output Power vs. Input Voltage

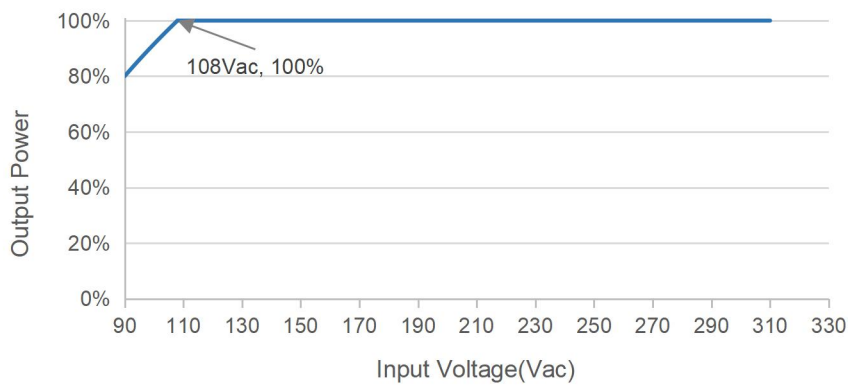

Efficiency vs. Load (I_o=1.05A)

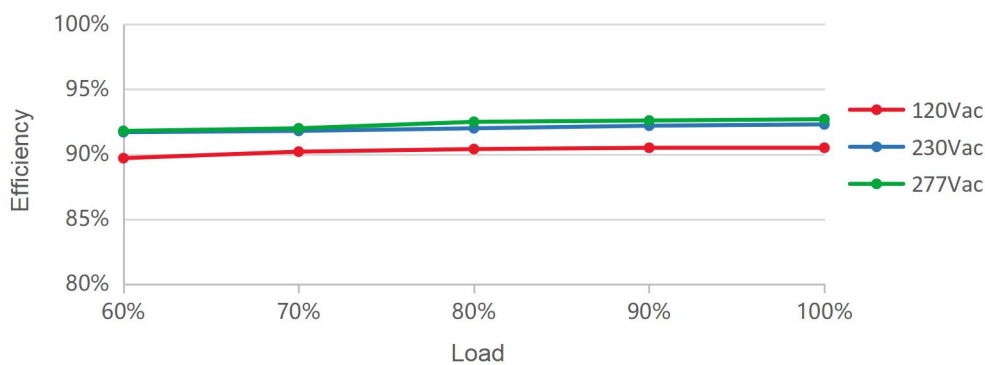

Efficiency vs. Load (I_o=0.70A)

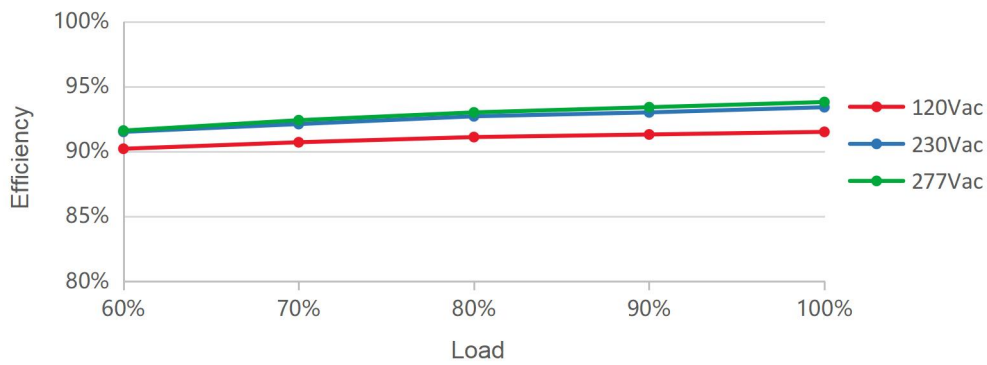

PF vs. Load

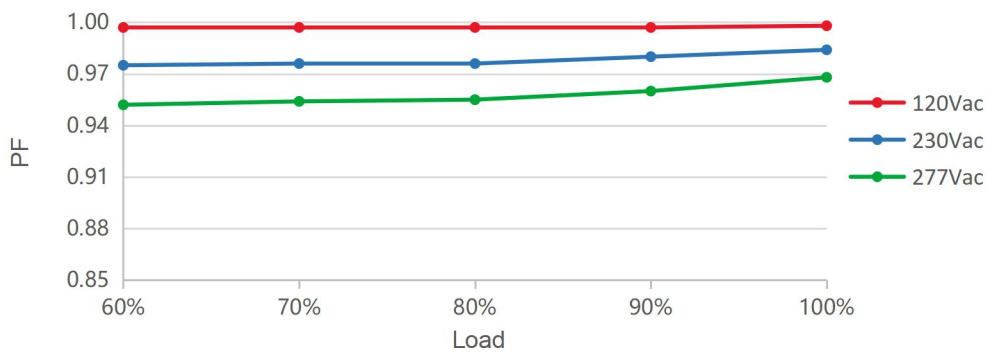

THD vs. Load

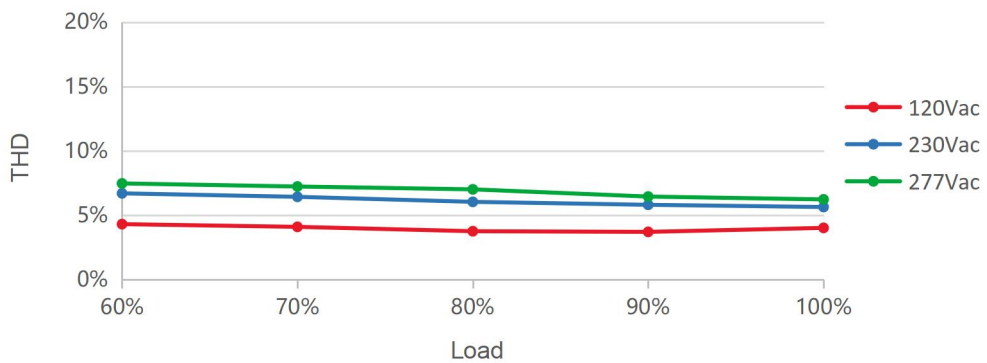

Output Power vs. Ambient Temperature

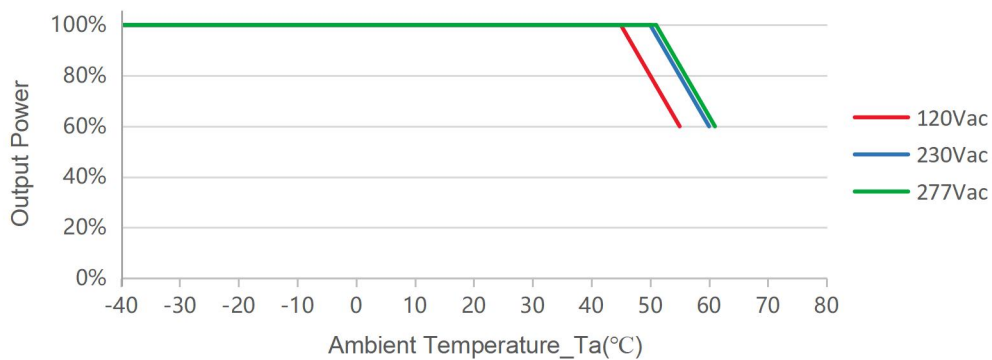

Lifetime vs. Case Temperature

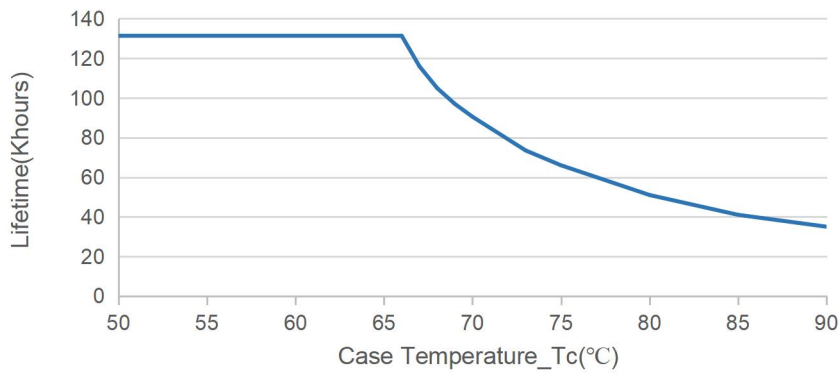

0-10V/PWM Dimming

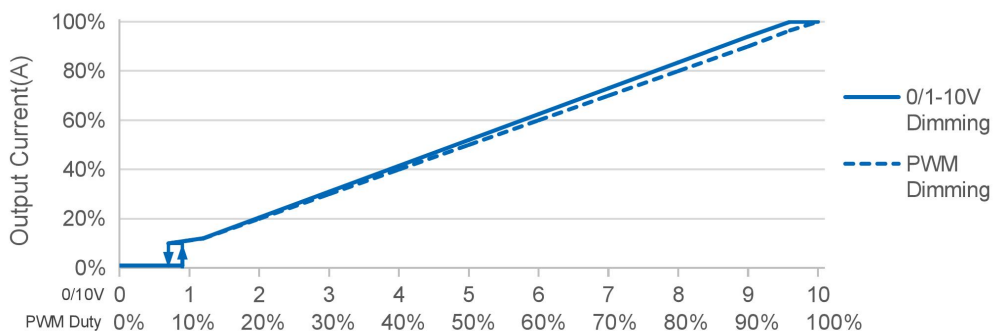

NFC Adjustable Driver



LED Driver Configurer Tool V0.6437 test_sc

MOSO 茂硕电源 中文

Scan Port: NFC0 Close

Driver Type: X7-150M056 Auto Set

Max Out Current 1: 4300 mA

Log

```
test_sc 17:01:57.146 NFC0 :
E0023800B1E70400 set NFC tags success
```

Introduction to software operation:

1. Connection between computer and NFC reader.
2. Open the software on the PC.
(The software can be downloaded from the MOSO official website)
3. Click "Scan Port" to find "NFC0".
4. Place the MOSO driver on the NFC reader. After identifying the driver, the indicator on the NFC reader will change from red to green.
5. Then set the output current we need.
6. Click "Auto set". Then, the NFC reader beeps, and the current is modified successfully.

Note:

The driver part No. are programmed as per the actual part No..

Mechanical Outline

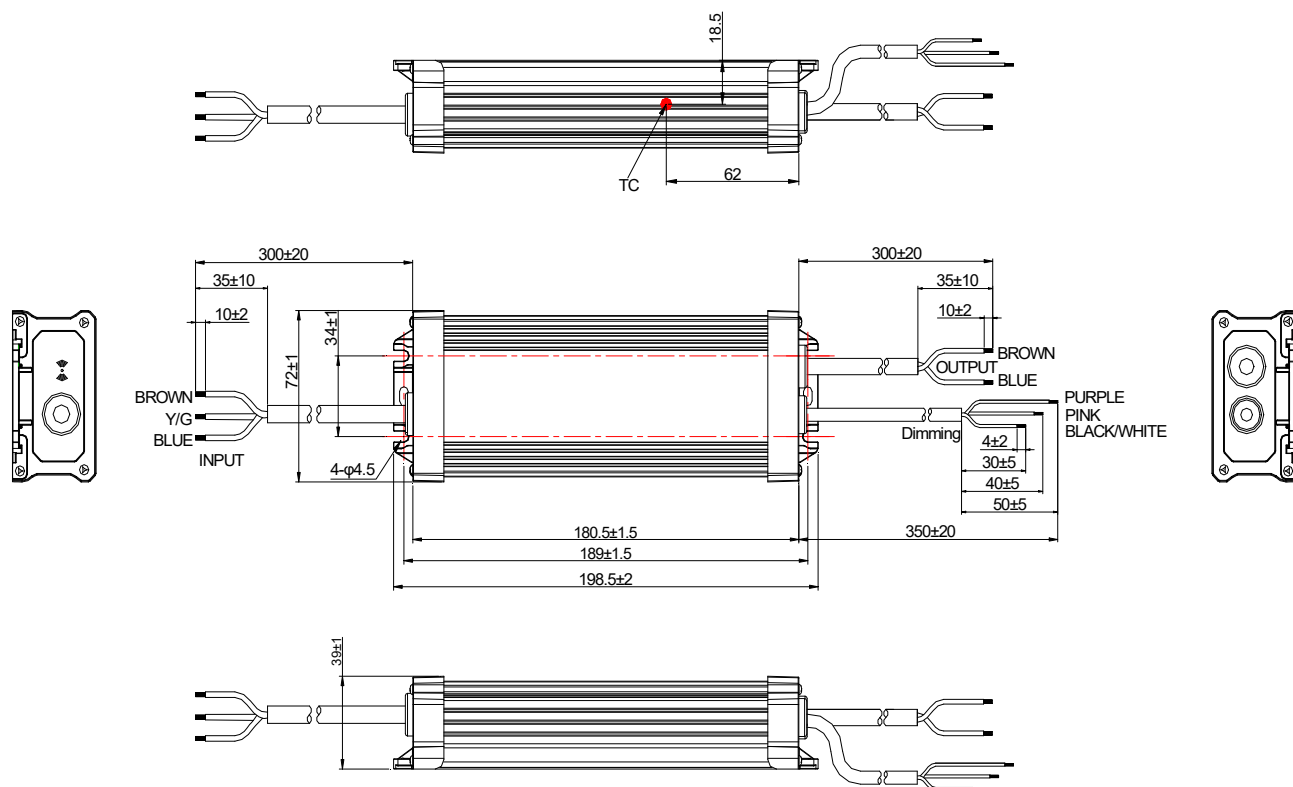

Specification

| | | |
|---------|---|----------------|
| Input | CCC+VDE 3x1.0mm ² external diameter:7.3 L=300±20mm | CCC/CE |
| Output | CCC+VDE 2x1.0mm ² external diameter:6.9 L=300±20mm | CCC/CE |
| Dimming | UL21996 22AWG*3C Ø5.0mm L=350±20mm | Dim+/Dim-, A12 |

Label

INPUT

L (BROWN 棕)

G (Y/G 黄/绿)

N (BLUE 蓝)

MOSO[®] X7-200M286A12

Constant current type LED DRIVER
LED 恒流控制装置(内置防雷管)

| | |
|-------------|---|
| INPUT (输入) | 100-240V~ 50/60Hz, 2.5A Max. PF:0.95, 240W |
| OUTPUT (输出) | 143-286V ^{max} 0.105-1.050A Uout Max. (最大电压):320V ^{max} Max. Power(最大功率):200W |
| tc:90°C | ta:45°C Input:100-200V~ ta:50°C Input:200-240V~ |

MADE IN CHINA
For LED module only
Integrated SPD

SHENZHEN MOSO ELECTRONICS TECHNOLOGY CO., LTD
No.1061, Songbai Road, Xili Town, Nanshan District,
Shenzhen, CHINA

OUTPUT

(BROWN 棕) Vo +

(BLUE 蓝) Vo -

(PURPLE 紫) DIM +*

(PINK 粉) 12V/DIM* -*

(BLACK/WHITE 黑白) 12V** *

Note:
Nameplate is laser engraved.

Version

| | | |
|-----|---------------|------------|
| A.1 | First release | 2023-07-07 |
| B.2 | ECL202311023 | 2023-11-16 |
| | | |
| | | |
| | | |
| | | |

Specification for Approval

Product Name: 200W LED Driver

Product Model: X7-200M286A12

Rev: B.2

Address: XiLiSongbai Road 1061, Nanshan District, Shenzhen City, Guangdong, China

Tel: 0755-27657000

FAX: 755-27657908

E-mail: info@mosopower.com

Web Site: http://www.mosopower.com

| Prepared By | Checked By | Approved By |
|-------------|------------|-------------|
| | | |

Specification for Approval

Product Name: 200W LED Driver

Product Model: X7-200M286A12

Rev: B.2

| CUSTOMER AUTHORIZED SIGNATURE | | |
|---|-------------------|--------------------|
| Tested By | Checked By | Approved By |
| | | |
| (Company seal)Return one copy to MOSO with approved signature and company seal. | | |

Address:XiLiSongbai Road 1061, Nanshan District, Shenzhen City, Guangdong, China

Tel: 0755-27657000

FAX: 755-27657908

E-mail:info@mosopower.com

Web Site:http://www.mosopower.com

| Prepared By | Checked By | Approved By |
|--------------------|-------------------|--------------------|
| | | |