

Description

The X6E series is outdoor LED driver that operates in constant current with high PF value and full power input voltage range 176~305Vac model. It also helps clients to improve the management of logistics and stock. The compact metal case and high efficiency enables the driver to operate with high reliability. It provides extreme durability with an IP67 rating and extends product lifetime. Overall protection is provided against lightning surge, output over voltage, short circuit and over temperature to ensure low failure rate.



Product Features

- Universal input voltage: 90~305Vac
- Full power work range: 176~305Vac;
- Isolated constant power design;
- High surge protection: 6KV line-line, 10KV line-earth;
- Protections: SCP / OVP / OTP;
- IP67 design for indoor and outdoor applications;
- Suitable for dry / damp / wet locations;
- 5 years warranty;

Application

Road and street lighting,
Tunnel lighting
Area and flood lighting
High-bay lighting

Models

Model Number	Input Voltage Range (Vac)	MAX Output Power (W)	Output Voltage Range (Vdc)	Full Power Output Current Range (A)	Default Current(A)	Eff. (Typ.)	PF(Typ.)	THD(Typ.)
X6E-240V240	100~277	240	130-240	1.0~1.5	1.5	93%	0.97	5%

NOTES:

- [1]. V means non-dimmable, adjustable output current with potentiometer.
- [2]. All specifications are measured at 25°C ambient temperature, input voltage 230Vac, and the typical value tested by full load, if no specific note.

Input Specifications

Parameter	Min	Typ.	Max	Notes
Input Voltage Range	90Vac	220~240Vac	305Vac	
Full Power Work Range	176Vac	220~240Vac	277Vac	Reference Output Power vs. Input Voltage curve
Input Frequency AC	47Hz	50/60Hz	63Hz	
Max Input Current	-	-	1.8A	176Vac & 100% load
Max Input Power	-	-	280W	176Vac & 100% load
Leakage Current	-	-	0.70mA	IEC 60598-1; 240Vac/60Hz
Inrush Current	-	-	75A	240Vac, 100% load
Power Factor (PF)	0.93	0.95	-	220-240Vac, 50-60Hz, 70%-100% load
Total Harmonic Distortion (THD)	-	5%	10%	220-240Vac, 50-60Hz, 70%-100% load
MCB(B16)	-	4	-	220Vac; 100%load

Output Specifications

Parameter	Min	Typ.	Max	Notes
Output Voltage Range	130Vdc	-	240Vdc	The full power cannot be lower than 160Vdc
Open Circuit Voltage	-	-	260Vdc	
Output Current Range	0.66A	-	1.50A	Adjustable output current with potentiometer, full power performance range 1.00A-1.50A
Current Accuracy	-5% _{I_{set}}	-	+5% _{I_{set}}	I _{set} is set to the full power range.
Total Output Current Ripple (pk-pk)	-	5%	10%	20MHz BW full load & LED load the LED load ripple is slightly different for different leds
Startup Overshoot Current	-	5%	10%	220-240Vac full load condition, LED load
Line Regulation	-1%	-	+1%	25°C±10°C ambient temperature, input changes from 200Vac to 264Vac
Load Regulation	-3%	-	+3%	Load varies from 70% to 100% with 230Vac Input at 25°C±10°C ambient temperature
Turn-on Delay Time	-	-	1.0s	240Vac, 100% load

General Specifications

Parameter	Min	Typ.	Max	Notes
Efficiency@230Vac Io=1.0A Io=1.5A	91% 90%	93% 92%	-	100% load, 25°C ambient
Mean Time Between Failure	-	200Khours	-	25°C±10°C ambient temperature, 230Vac, 80% load condition (MIL-HDBK-217/SR-332)
Lifetime	-	50Khours	-	230Vac & 100% load, Tc 75°C, reference lifetime vs. case temperature curve
Operating Temperature Ta	-40°C	-	+50°C	Output Power vs. Ambient Temperature curve
Operating Tc for Safety Tc_s	-40°C	-	+90°C	
Operating Tc for Warranty Tc_w	-40°C	-	+75°C	5-year warranty shell temperature, humidity: 10% to 95% RH
Storage Temperature Ta	-40°C	-	+85°C	Humidity: 5% to 100% RH
Altitude	-60m	-	4000m	
Input Under voltage Protection	65Vac	75Vac	85Vac	Turn off the output or hiccup when the input voltage falls below protection voltage.
Over Temperature Protection_Tc	-	95°C	-	Decreases output current, returning to normal after over temperature is removed.
Short Circuit Protection	-	-	-	Hiccupmode. The output shall return to normal when the fault condition is removed.
Dimensions (L*W*H)	193.6*68*39mm			
Net Weight	930±100g/PCS			
Package(L*W*H)	502*372*222mm; 15PCS/Ctn, Gross Weight: 17Kg			

Safety Specification

Parameter	Min	Typ.	Max	Notes
Dielectric Strength (Input-Output)	-	3750Vac	-	60s, Current not exceeding 5mA
Dielectric Strength (Input-Ground)	-	1554Vac	-	60s, Current not exceeding 5mA
Dielectric Strength (Output-Ground)	-	1520Vac	-	60s, Current not exceeding 5mA
Grounding Resistance	-	-	0.1Ω	25°C±10°C Ambient Temperature, pass 25A Current, 60s.
Insulation Resistance	10MΩ	-	-	Input-Output, Input-PE, Output-PE, 500Vdc/60s/25°C

Safety Compliance

Safety Category	Standards	Approved	Notes
CCC	GB19510.1,GB19510.14	√	
CE	EN61347-1, EN61347-2-13, EN62493	√	
ENEC	EN61347-1, EN61347-2-13, EN62384	√	
CB	IEC61347-1, IEC61347-2-13	√	
BIS	IS 15885(PART 2/SEC 13)		
UL	UL 8750		
CUL	CSA C22.2 No.250.13		
KC	K61347-1, K61347-2-13		
PSE	J61347-1, J61347-2-13		
SAA	AS 61347.2.13, AS/NZS 61347.1	√	
EAC	ГОСТ Р МЭК 61347-1 ГОСТ IEC 61347-2-13	√	

EMC Compliance

EMC Category	Standards	Approved	Notes
CCC	GB/T 17743, GB 17625.1	√	
CE	EN 55015	√	
CE	EN 61000-3-2, EN 61000-3-3	√	
CE	EN61000-4-2,3,4,5,6,11	√	
CE	EN 61547	√	
KC	K61547		
KC	K00015		
PSE	J55015		
FCC	FCC part 15		
Surge Shock Immunity	ANSI/C82.77-5-2017		
Ringing Wave			
EAC	ГОСТ IEC 62493, СТБ EH 55015 ГОСТ IEC 61547	√	
EAC	ГОСТ 30804.3.2 (IEC 61000-3-2) ГОСТ 30804.3.3 (IEC 61000-3-3)	√	

RoHS

Our products comply with reference to RoHS Directive (EU) 2015/863 amending 2011/65/EU.

Inrush Current

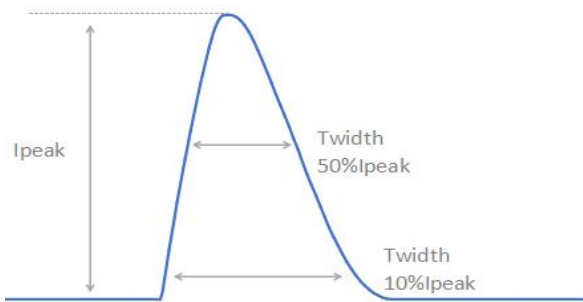

Vin	Ipeak	T(@10% of Ipeak)	T(@50% of Ipeak)
220Vac	61A	616uS	380uS

Output Voltage vs. Output Current

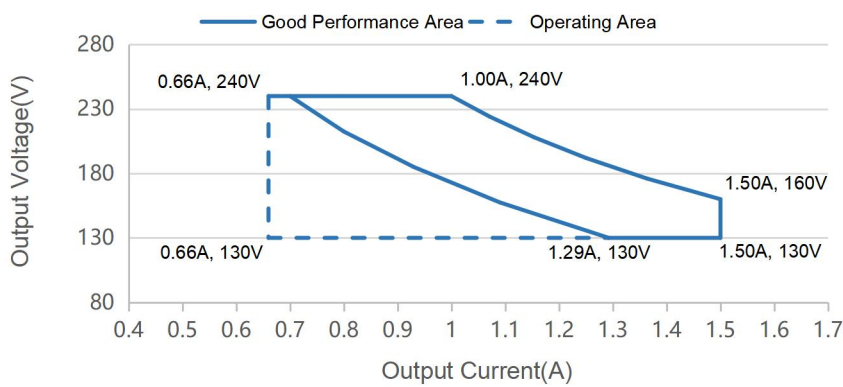

Output Power vs. Input Voltage

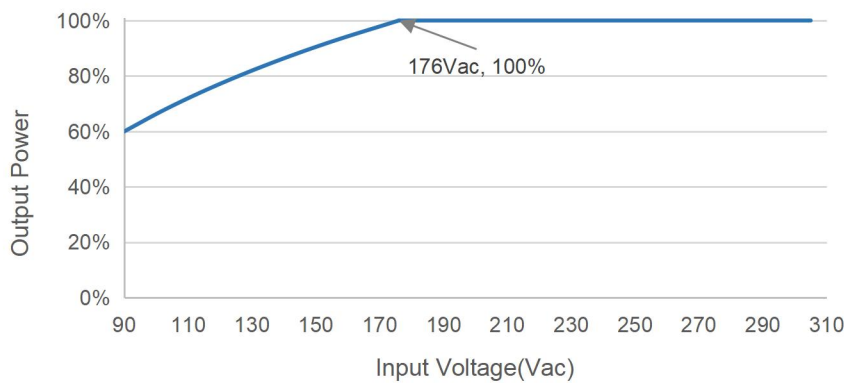

Efficiency vs. Load

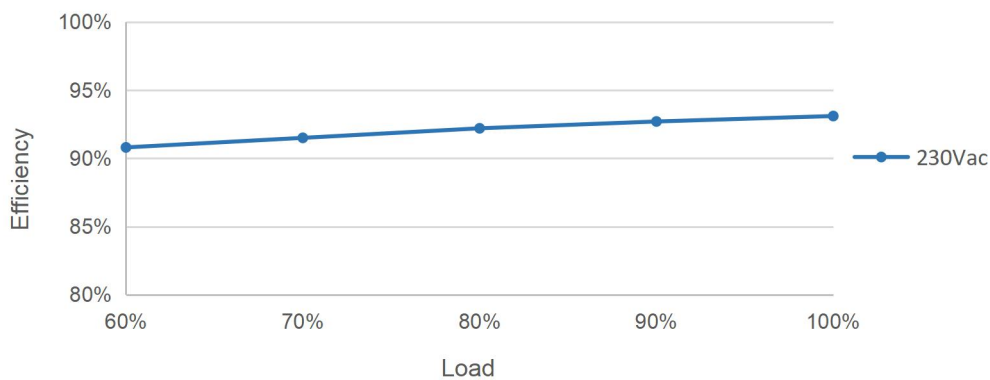

PF vs. Load

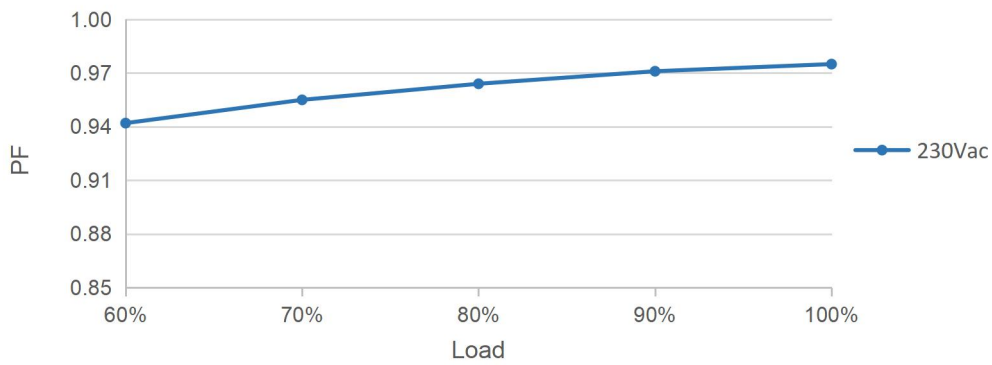

THD vs. Load

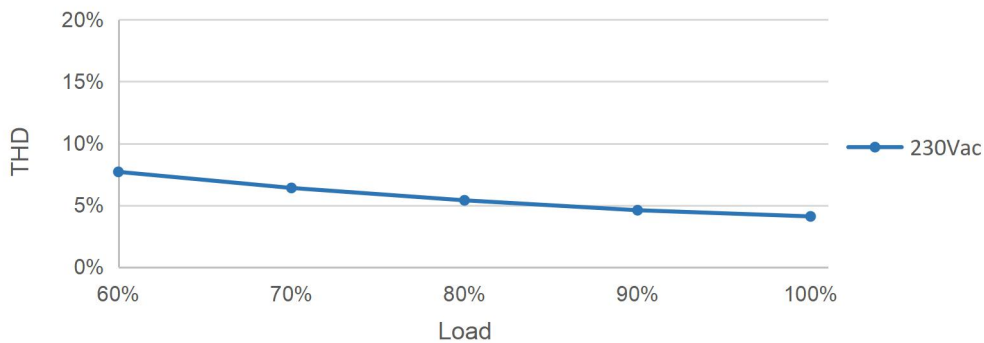

Output Power vs. Ambient Temperature

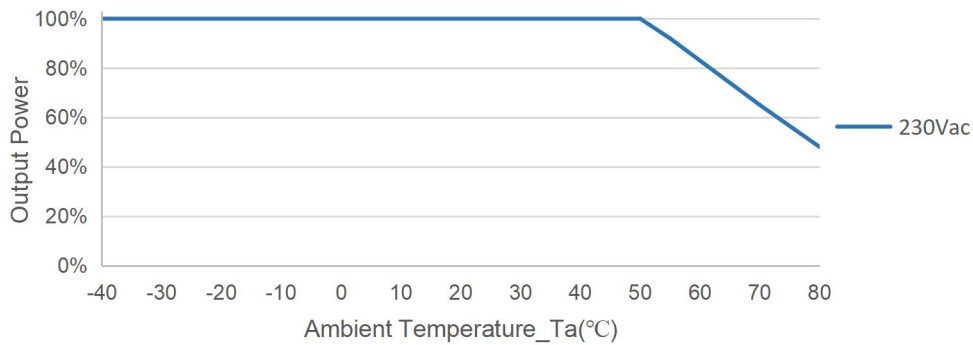

Lifetime vs. Case Temperature

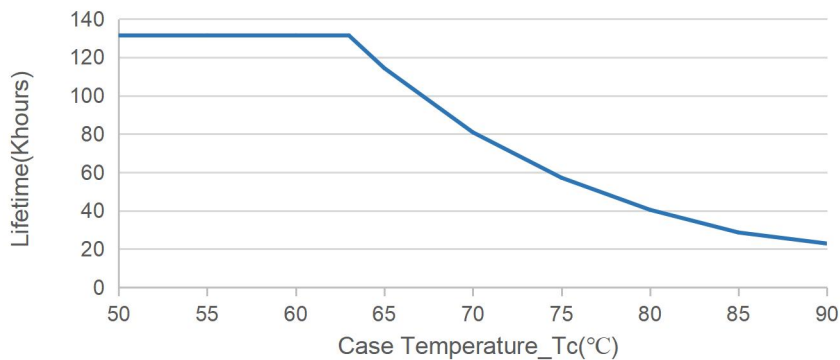

Mechanical Outline

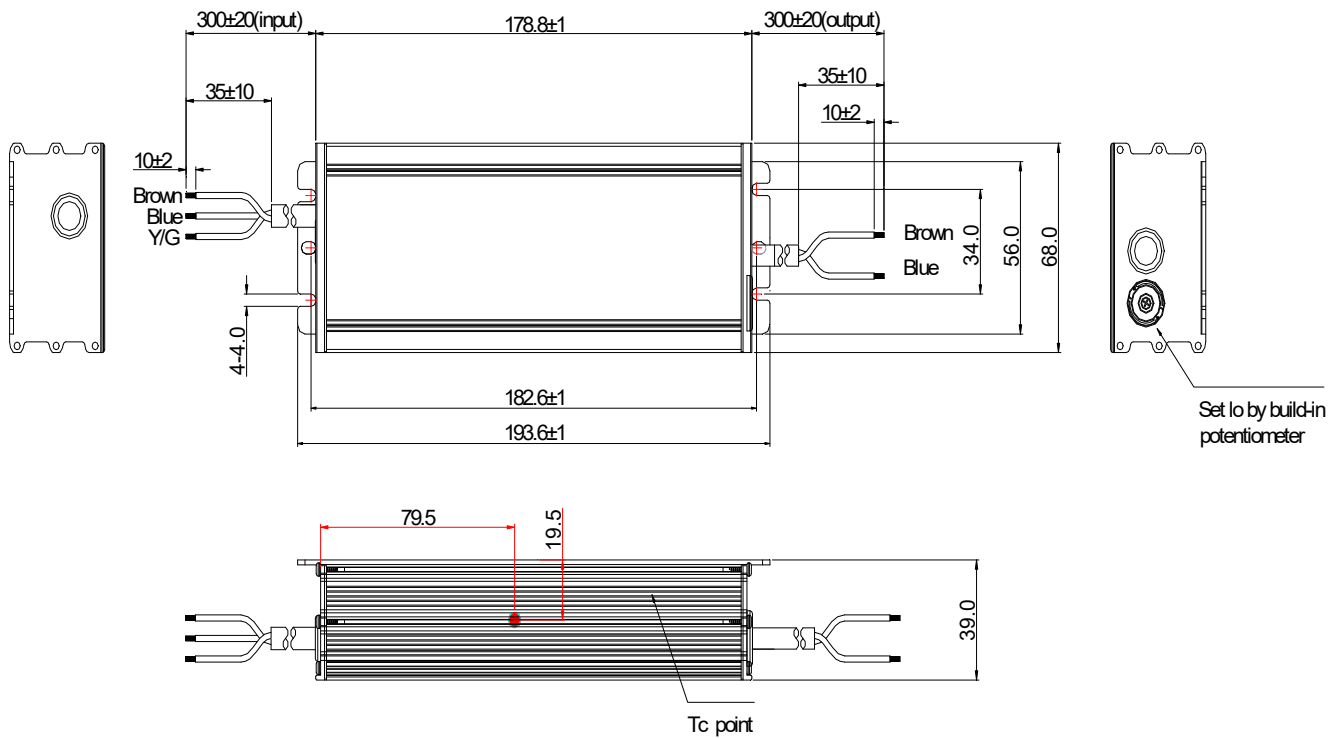

Specification

Input	CCC+VDE H05RN-F 3*1.0 mm ² L=300±20mm	CCC/CE
Output	CCC+VDE H05RN-F 2*1.0 mm ² L=300±20mm	CCC/CE

AC wire labels

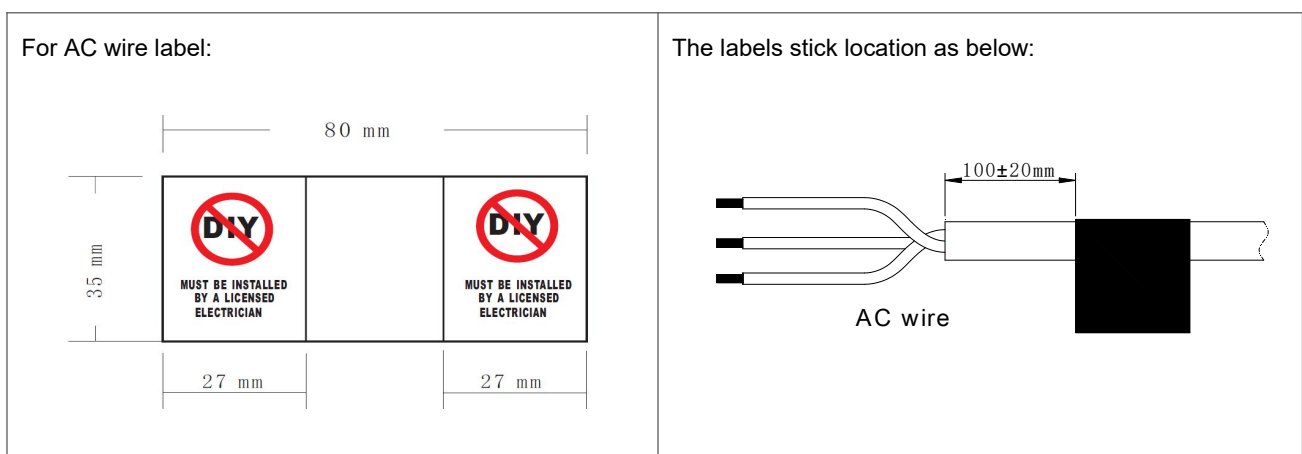

Label

<p>MOSO[®] X6E-240V240 LED DRIVER Constant current type LED 控制装置 Integrated SPD 恒流型 内置防雷管</p>		CCC	CE	EAC	OUTPUT
INPUT	Uout(最大电压):260V ~				(BROWN 棕) Vo +
L (BROWN 棕)	INPUT (输入) 100-277V ~ 50/60Hz, 280W Max. 1.8A Max. PF: (Pout≥120W) = 0.85C-0.95				(BLUE 蓝) Vo -
G (Y/G 黄/绿)	OUTPUT (输出) 130-240V ~ 240W Max. 0.90-1.50A (Input: 176-277V ~) 150W Max. 0.66-0.90A (Input: 100-176V ~)		IP67	RoHS	Io ADJ (+)
N (BLUE 蓝)	ta:50°C tc:90°C				EESS-230770-0
<p>中国制造 仅适用LED模块 MADE IN CHINA For LED module only</p> <p>深圳茂硕电子科技有限公司 SHENZHEN MOSO ELECTRONICS TECHNOLOGY CO.,LTD No. 1061, Songbai Road, Xili Town, Nanshan District, Shenzhen, CHINA</p>					

Version

A.2	First release	2023-10-07
B.2	ECL202503028	2025-03-26

Specification for Approval

Product Name: 240W LED Driver

Product Model: X6E-240V240

Rev: B.2

Address: XiLiSongbai Road 1061, Nanshan District, Shenzhen City, Guangdong, China

Tel: 0755-27657000

FAX: 755-27657908

E-mail: info@mosopower.com

Web Site: <http://www.mosopower.com>

Prepared By	Checked By	Approved By

Specification for Approval

Product Name: 240W LED Driver

Product Model: X6E-240V240

Rev: B.2

CUSTOMER AUTHORIZED SIGNATURE		
Tested By	Checked By	Approved By
(Company seal)Return one copy to MOSO with approved signature and company seal.		

Address:XiLiSongbai Road 1061, Nanshan District, Shenzhen City, Guangdong, China

Tel: 0755-27657000

FAX: 755-27657908

E-mail:info@mosopower.com

Web Site:http://www.mosopower.com

Prepared By	Checked By	Approved By