



给您一颗快乐的“芯”！

Crystal Resonator X503224MSB4SI



Features

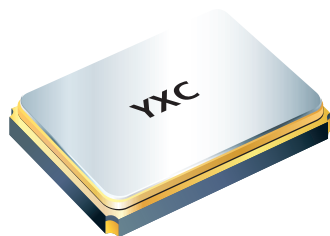

- External dimensions: 5.0 x 3.2 x 0.9 mm.
- Frequency : 24.000MHz
- High precision characteristics covering up to wide frequency range.
- Higher frequency stability and reliability.
- Excellent for reducing EMI effect.
- The best choice of Bluetooth, wireless communication set, DSC, PDA, mobile phone and USB interface card.

Electrical Specifications

Item / Type	X503224MSB4SI
Nominal Frequency Range	24MHz
Vibration Mode	AT Fundamental
Load Capacitance	20pF
Frequency Tolerance (at 25 °C)	± 10 ppm
Frequency Versus Temperature Characteristics	±20 ppm
Operating Temperature	- 40 ~ + 85 °C
Storage Temperature	-40 ~ + 105°C
Shunt Capacitance	7 pF Max.
Level Of Drive	1~100 μW Max. (10 uW typical)
Frequency Aging (at 25 °C)	± 3 ppm / year Max.
Insulation Resistance	More Than 500MΩ at DC 100V

Equivalent Series Resistance(ESR)

Fundamental	
8 ~ 12 MHz	60 Ω ~ 80 Ω
12 ~ 25 MHz	40 Ω ~ 60 Ω
25 ~ 54 MHz	30 Ω ~ 40 Ω

Dimensions

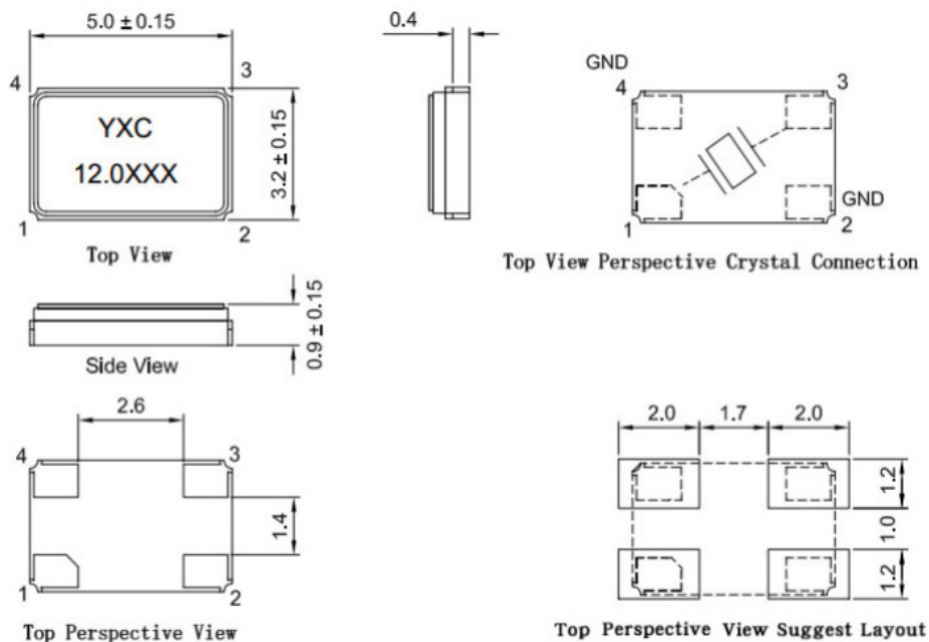

Units: mm



给您一颗快乐的“芯”！

Crystal Resonator X503224MSB4SI

★ PART NUMBER GUIDE 部件号示例 e.g. X503224MSB4SI YSX531SL=5.0 ×3.2 SMD SEAM TYPE

Quartz Crystal Resonator	Dimensions	Frequency (MHz)	Load Capacitance (Pf)	Frequency Stability Overall (ppm)	Pin	Material	Operating Temp. Range
Crystal Resonator	5.0*3.2mm	24MHz	20pf	±20ppm	4 pin	Metal	-40~+85

★ TAPING SPECIFICATION (Unit: mm) 编带规格

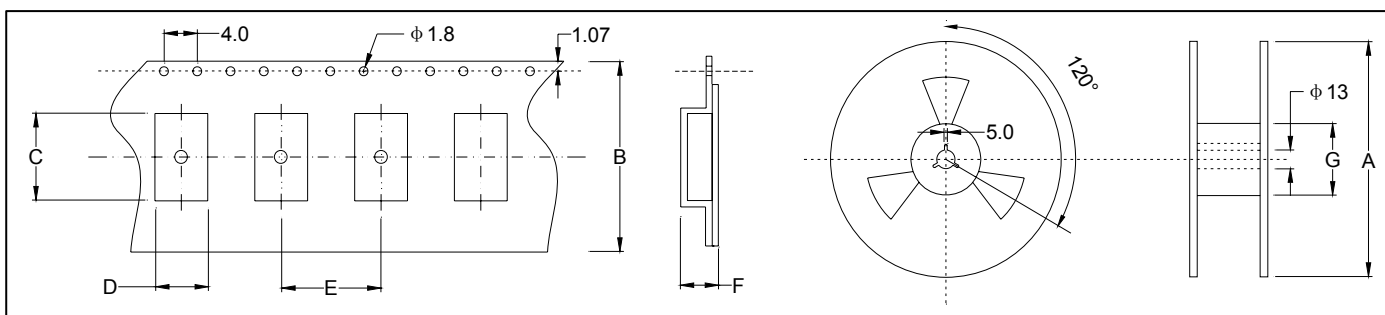

	A	B	C	D	E	F	G
SMD5032	178±2.0	12.0±0.3	5.80±0.10	4.05±0.10	7.65±0.1	1.60±0.10	57.15±1.0
1000 pcs per reel							

★ REFLOW SOLDERING PROFILE 回流焊特性

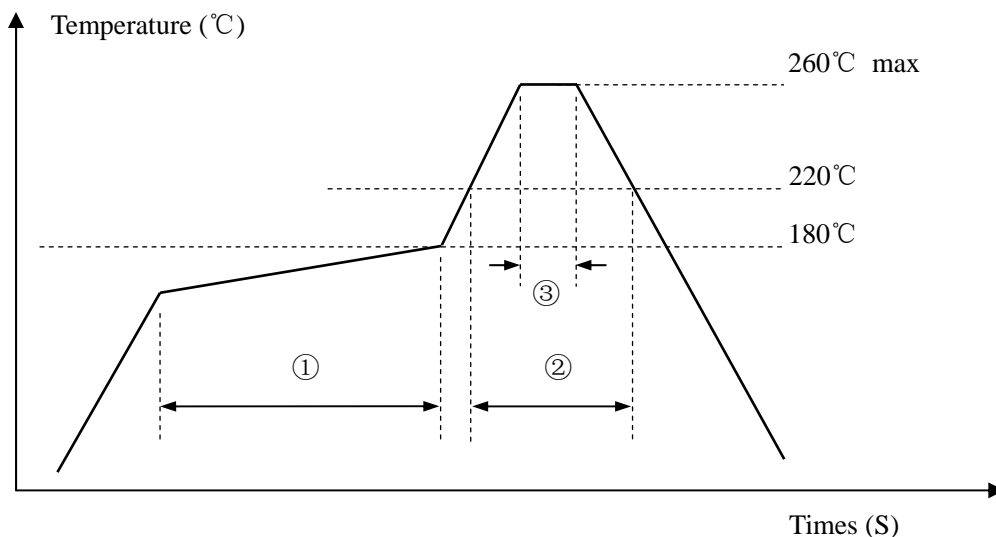

Pb free reflow A	①	Preheat	160~180°C	120sec. max
	②	Primary heat	220°C	60sec. max
	③	Peak	260°C	10sec. max.