

Features

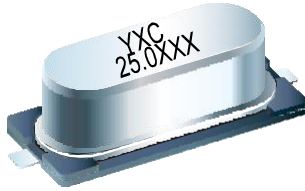

- External dimensions: 11.4 x 4.8 x 3.8 mm.
- Frequency range: 3.579545MHz ~ 64MHz.
- Surface mount type crystal units.
- A great number of standard frequencies.
- High frequency pullability and low equivalent series resistance.
- Highly mass production capability.
- Applications: PC, STB, LCDM and Cable Modem.

Electrical Specifications

Item / Type	X49SM25MQD2SI
Nominal Frequency Range	25.0Mhz
Vibration Mode	AT Fundamental
Load Capacitance	16pF
Frequency Tolerance (at 25 °C)	± 20 ppm
Frequency Versus Temperature Characteristics	± 30 ppm
Operating Temperature	- 40 ~ + 85 °C
Storage Temperature	- 40 ~ + 105 °C
Shunt Capacitance	7 pF Max.
Level Of Drive	1 ~ 500 μ W (100 μ W typical)
Frequency Aging (at 25 °C)	± 3 ppm / year Max.

Equivalent Series Resistance(ESR)

Fundamental		3rd Overtone	
3.579545 ~ 4 MHz	150 Ω Max.	20 ~ 25 MHz	100 Ω Max.
4 ~ 5 MHz	120 Ω Max.	25 ~ 64 MHz	80 Ω Max.
5 ~ 6 MHz	100 Ω Max.		
6 ~ 7 MHz	80 Ω Max.		
7 ~ 10MHz	60 Ω Max.		
10 ~ 27MHz	40 Ω Max.		

Dimensions

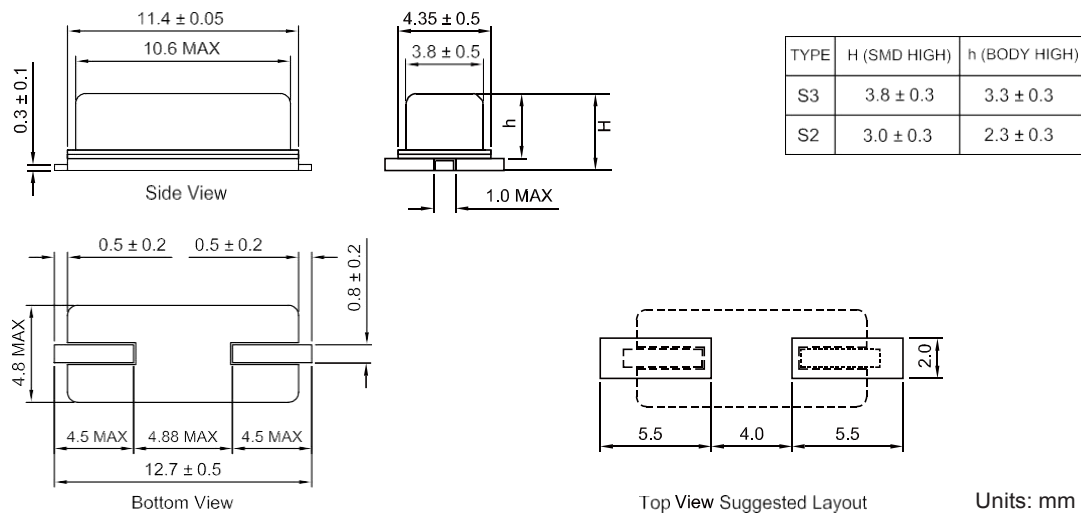

给您一颗快乐的“芯”！

HC-49SMD X49SM25MQD2SI

★ PART NUMBER GUIDE 部件号示例 e.g. X49SM25MQD2SI

HC-49SMD=11.4×4.35 SMD SEAM TYPE

Quartz Crystal Resonator	Dimensions	Frequency (MHz)	Load Capacitance (Pf)	Frequency Stability Overall (ppm)	Pin	Material	Operating Temp. Range
Passive Crystal	49SMD	25MHz	16.0pf	±20ppm	2 Pin	Metal	-40~+85 °C

★ REFLOW SOLDERING PROFILE 回流焊特性

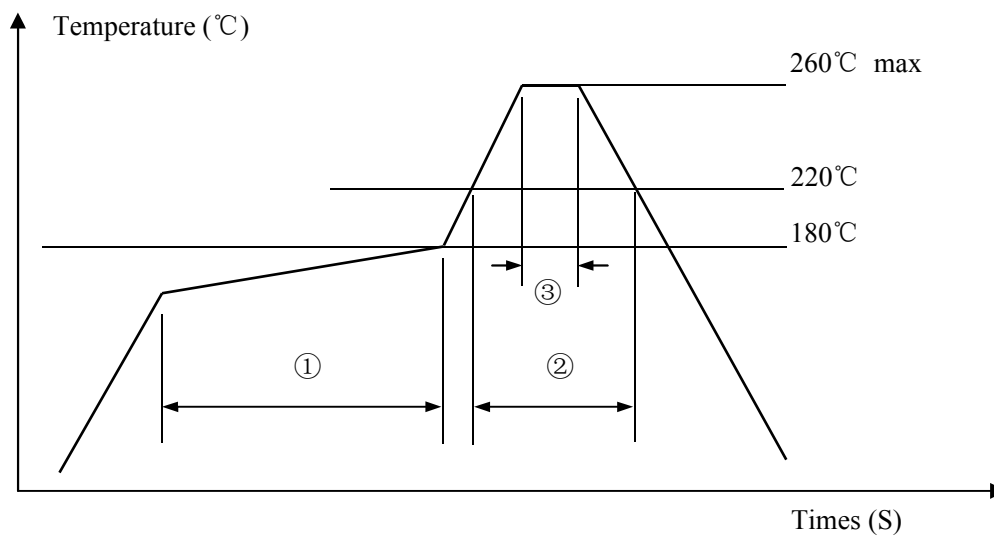

Pb free reflow A	①	Preheat	160~180°C	120sec. max
	②	Primary heat	220°C	60sec. max
	③	Peak	260°C	10sec. max.