

Features



- External dimensions: 3.2 x 2.5 x 0.8 mm.
- Frequency range: 11.0592MHz ~ 54MHz.
- High precision and high frequency stability.
- Extremely good for reducing EMI effect.
- RoHS Compliant / Pb Free.
- The best choice of Bluetooth, wireless communication set, DSC, PDA and mobile phone.

Electrical Specifications

Item / Type	X322524MOB4SI
Nominal Frequency	24 MHz
Vibration Mode	AT Fundamental
Load Capacitance	12pF
Frequency Tolerance (at 25 °C)	± 10 ppm
Frequency Versus Temperature Characteristics	± 20 ppm
Operating Temperature	- 40 ~ + 85 °C
Storage Temperature	- 40 ~ + 105 °C
Shunt Capacitance	7 pF Max.
Level Of Drive	1~100 μW Max. (10 uW typical)
Frequency Aging (at 25 °C)	± 3 ppm / year Max.
Insulation Resistance	More Than 500MΩ at DC 100V

Equivalent Series Resistance(ESR)

Fundamental	
11.0592 ~ 16 MHz	80 Ω Max.
16 ~ 20 MHz	60 Ω Max.
20 ~ 54 MHz	40 Ω Max.

Dimensions

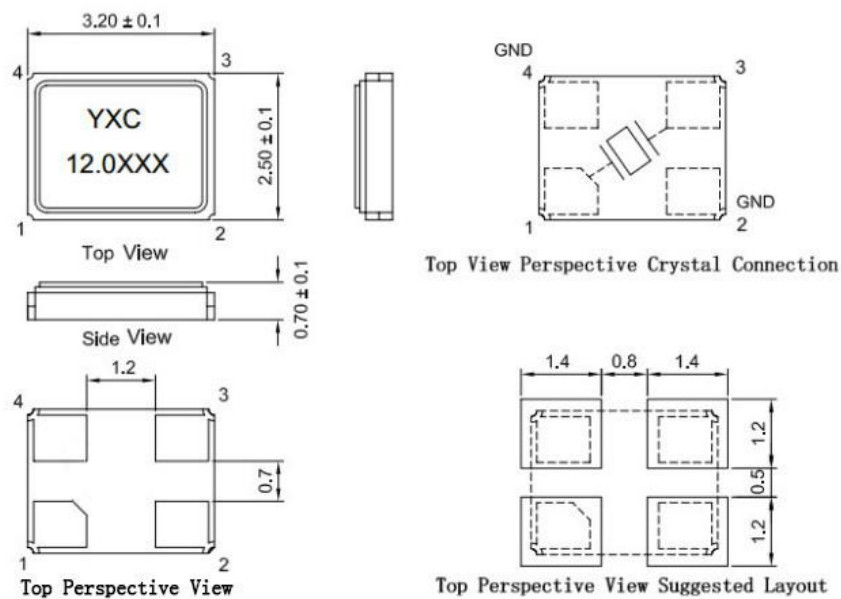

Units: mm

★ PARTNUMBER GUIDE 部件号示例 e.g. X322524MOB4SI

YSX321SL = 3.2 × 2.5 SMD SEAMTYPE

Quartz Crystal Resonator	Dimensions	Frequency (MHz)	Load Capacitance (Pf)	Frequency Stability Overall (ppm)	Pin	Material	Operating Temp. Range
Crystal Resonator	3.2* 2.5mm	24.00MHz	12pf	±10ppm	4 pin	Metal	-40~+85 °C

★ TAPING SPECIFICATION (Unit: mm) 编带规格

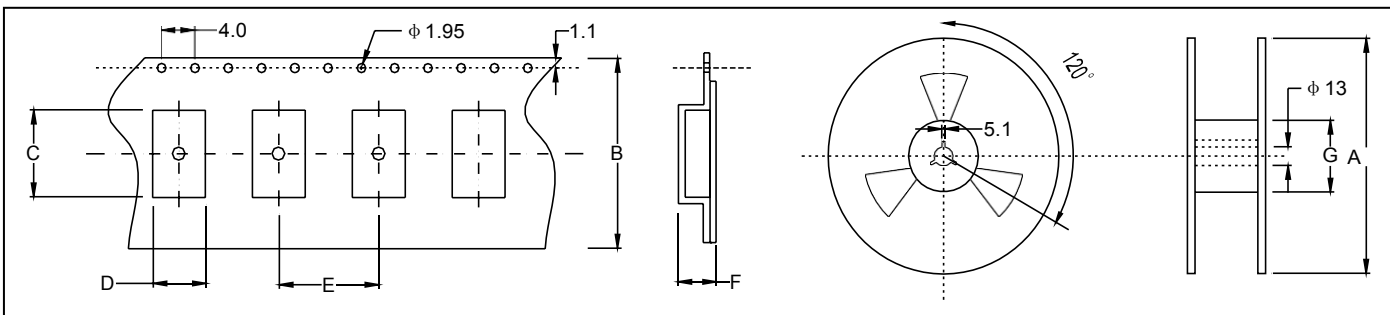

	A	B	C	D	E	F	G
SMD3225	178 ± 2.0	8.03 ± 0.3	3.81 ± 0.10	3.04 ± 0.10	3.84 ± 0.1	1.54 ± 0.10	62.0 ± 1.0
3000 pcs per reel							

★ REFLOW SOLDERING PROFILE 回流焊特性

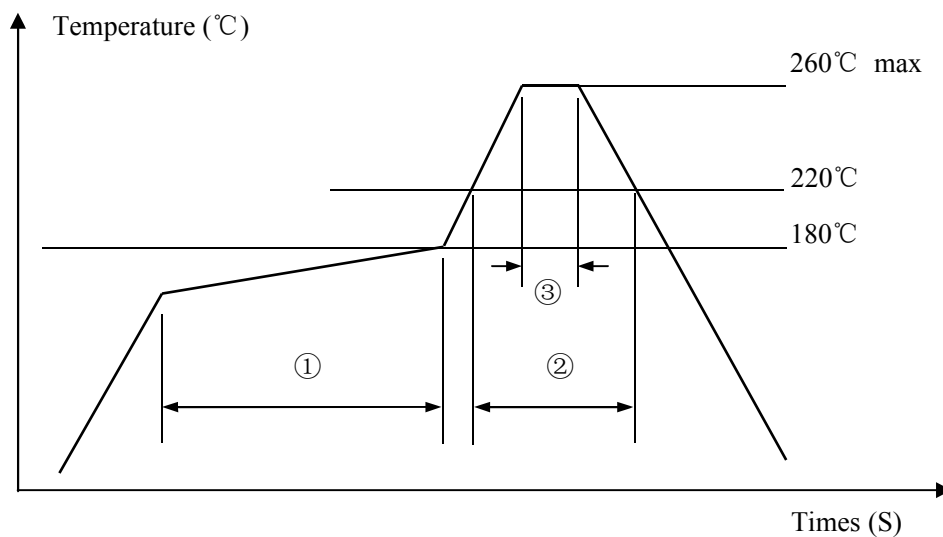

Pb free reflow A	①	Preheat	160~180 °C	120sec. max
	②	Primary heat	220 °C	60sec. max
	③	Peak	260 °C	10sec. max.