

WSKA750S-XXP

PCB Terminal Blocks > PCB Terminal Blocks

Date:2023-01-25Version:V1

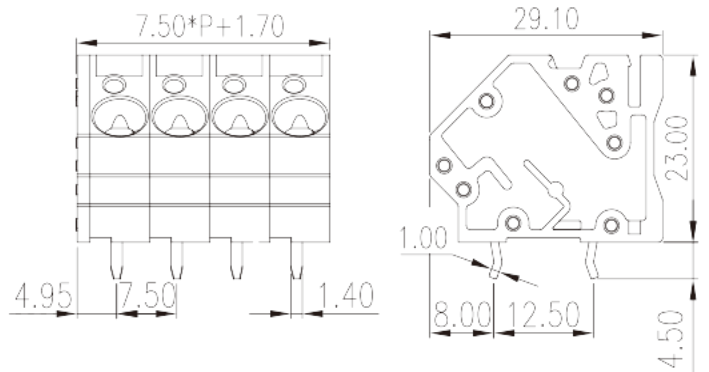
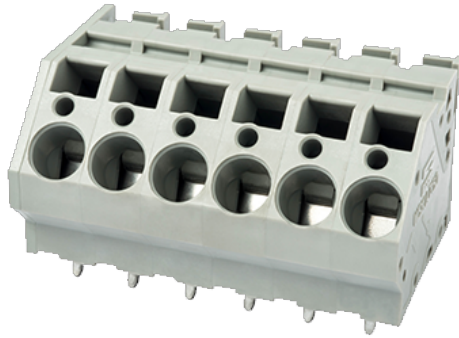

The web catalog is for reference only. Dinkle remains the right of product modification and engineering change of the design. The final product is made according to engineering drawing.

Product Description

Pitch : 7.50mm, 300V, 30A

General information

| | |
|--|--|
| Short description | PCB Terminal Blocks, Spring Clamp Connection |
| Category | PCB Terminal Blocks |
| Pitch (mm) | 7.50 |
| Color | Grey (default) |
| Connection method | Spring Clamp Connection |
| Type of locking | Without |
| Length (mm) | $7.50*(P-1)+9.2$ |
| Width (mm) | 29.1 |
| Height (mm) | 23 |
| Pin demensions (Thickness x Width)(mm) | 1.0x1.4 |
| PCB hole diameter (mm) | 2.2 |
| Number of positions | 01P~16P |
| Level | Single level |

Material information

| | |
|---------------------|----|
| Insulation material | PA |
|---------------------|----|

| | |
|--|-------------------|
| Insulation material group | I |
| Flame retardant rating , compliant with UL94 | V0 |
| Insulation resistance | □500MΩ at DC 500V |
| Conductor material | COPPER ALLOY |
| Plating of conductor surface | Tin PLATED |

Connection data-IEC

| | |
|---|---------|
| Rated voltage (V) | 630 |
| Rated current (A) | 41 |
| Rated voltage (II/2)(V) | 1000 |
| Rated voltage (III/2) (V) | 630 |
| Rated voltage (III/3)(V) | 500 |
| Rated impulse voltage (II/2)(KV) | 6 |
| Rated impulse voltage (III/2)(KV) | 6 |
| Rated impulse voltage (III/3)(KV) | 6 |
| Conductor cross section solid. min (mm ²) | 0.5 |
| Conductor cross section solid.max (mm ²) | 6 |
| Conductor cross section stranded. min (mm ²) | 0.5 |
| Conductor cross section stranded. max (mm ²) | 6 |
| Conductor cross section flexible, with min ferrule without plastic sleeve (mm ²) | 0.25 |
| Conductor cross section flexible, with max ferrule without plastic sleeve (mm ²) | 4 |
| Conductor cross section flexible, with min ferrule with plastic sleeve (mm ²) | 0.25 |
| Conductor cross section flexible, with max ferrule with plastic sleeve (mm ²) | 4 |
| 2 conductors with same cross section flexible, min twin ferrules with plastic sleeve (mm ²) | 0.5 |
| 2 conductors with same cross section flexible, max twin ferrules with plastic sleeve (mm ²) | 2.5 |
| Slotted screwdriver size (Blade thickness x Width)(mm) | 0.8x4.0 |
| Stripping Length (mm) | 14~15 |

Connection data-UL

| | |
|-----------------------------------|-----|
| Rated voltage (UL/CUL Group B)(V) | 300 |
| Rated current (UL/CUL Group B)(A) | 30 |
| Rated voltage (UL/CUL Group D)(V) | 300 |

| | |
|--|----|
| Rated current (UL/CUL Group D)(A) | 10 |
| Min. solid wire connection (AWG) acc. to UL/CUL | 26 |
| Max. solid wire connection AWG acc. to UL/CUL | 10 |
| Min. stranded wire connection AWG acc. to UL/CUL | 26 |
| Max. stranded wire connection AWG acc. to UL/CUL | 10 |

Environment & Safety

| | |
|---------------------------------|-----|
| Finger protection (YES or NO) | YES |
| Operating temperature. max (°C) | 120 |
| Operating temperature. min (°C) | -40 |

UL Recognized

| | |
|----------------------------|-------|
| Wire Range (Group B)(AWG) | 26~10 |
| Rated voltage (Group B)(V) | 300 |
| Rated current (Group B)(A) | 30 |
| Wire Range (Group D)(AWG) | 26~10 |
| Rated voltage (Group D)(V) | 300 |
| Rated current (Group D)(A) | 10 |

CUL Recognized

| | |
|----------------------------|-------|
| Wire Range (Group B)(AWG) | 26~10 |
| Rated voltage (Group B)(V) | 300 |
| Rated current (Group B)(A) | 30 |
| Wire Ranget (Group D)(AWG) | 26~10 |
| Rated voltage (Group D)(V) | 300 |
| Rated current (Group D)(A) | 10 |

Drawings

| | |
|--|--|
| | |
|--|--|

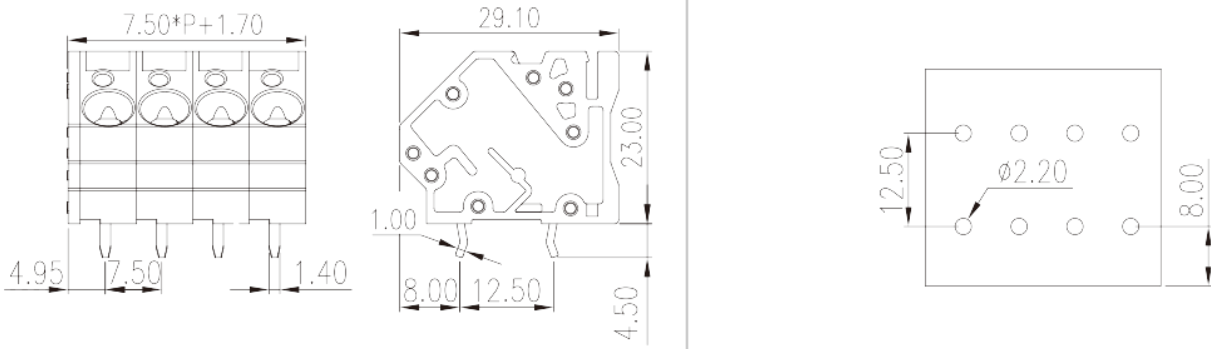

Approvals

