

Mechanical:

REV.	ECN NO.	DESCRIPTION	DATE	APPD
A	REL		2015-05-14	

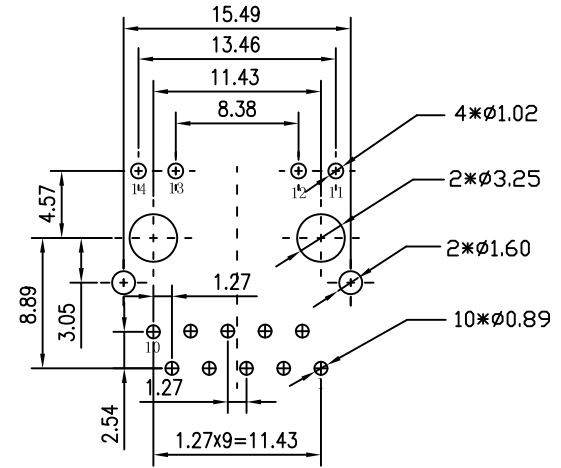

SUGGESTED PCB LAYOUT (TOP VIEW)

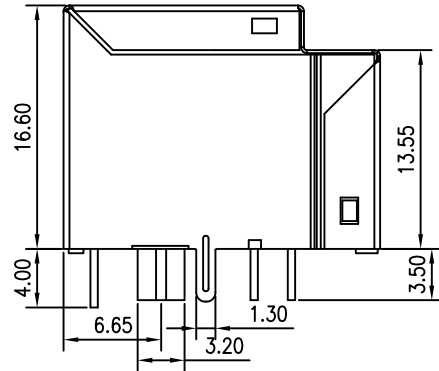
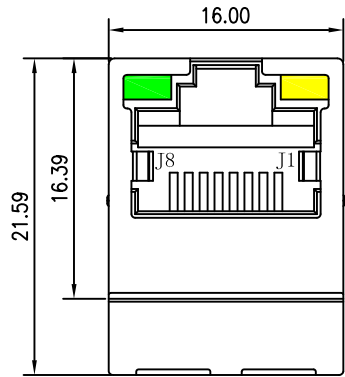
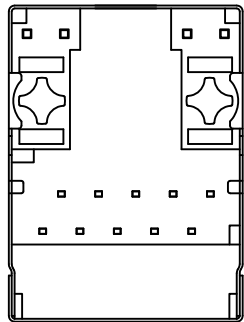

NOTES:

1. Meets IEEE 802.3 specification
2. Connector Materials:
 Housing Material: Thermoplastic PBT+30%G.F UL94V-0
 Contact Material: Phosphor Bronze C5210R-EH Thickness=0.35mm
 Pins: Brass C2680R-H Thickness=0.35mm
 Shield: Copper alloy Brass H65Y Thickness=0.2mm
 Contact plating: Gold 6 micro-inches min. In contact area.
3. Wave solder tip temperature: 265°C Max, 5 Sec Max
4. UL Certification: File Number E321120



X:X ±0.25	APPD:	Trxcom Huizhou Trxcom Electronics Co., Ltd.
X:XX ±0.20	CHKD:	
X:XXX ±0.05	DR: GRANT	
ANGLES ±1°	UNIT: mm	TITLE: Vertical RJ45 Connector with 1000 Base-TX Integrated Magnetics
		PART NO.: TRJD0720BENL
	SCALE: 2/1	SHEET: 1/4
	REV: A	DWG NO.: TRC15051411

Schematic:

REV.	ECN NO.	DESCRIPTION	DATE	APPD
A	REL		2015-05-14	

PCB CONNECTIONS

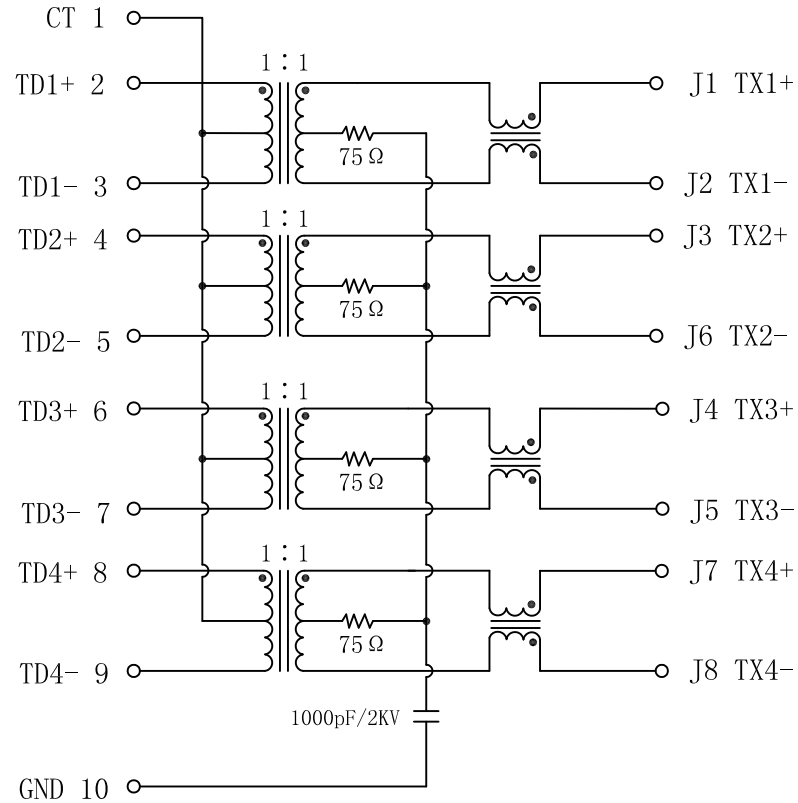

RJ45 CONNECTOR

ELECTRICAL SPECIFICATIONS @25°C

- Turn Ratio($\pm 3\%$):
TX=1CT:1CT RX=1CT:1CT
- Inductance OCL:
350uH MIN @ 100KHz 0.1V 8mA DC Bias
- DCR:
1.2 Ω MAX
- Insertion Loss:
-1.0dB MAX @ 1-100MHz
- Return Loss:
-18dB MIN @ 1-30MHz
-15dB MIN @ 30-60MHz
-12dB MIN @ 60-100MHz
- Cross talk:
-40dB MIN @ 1-30MHz
-35dB MIN @ 30-60MHz
-30dB MIN @ 60-100MHz
- Common Mode Rejection:
-30dB MIN @ 1-50MHz
-20dB MIN @ 50-100MHz
- Hipot Test:1500Vrms
- Operating Temperature Range: 0°C TO 70°C

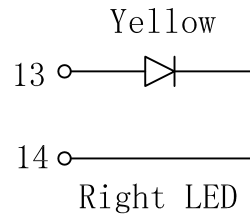
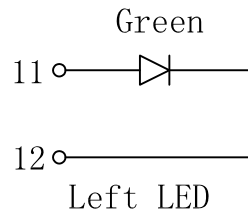
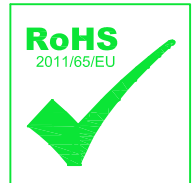

Emitting Color	λ p(nm)	VF@IF=20mA	IR @VR=5V
Green	570	1.8~2.4V	10 μ A max
Yellow	590	1.8~2.4V	10 μ A max

X:X	± 0.25	APPD:	Trxcom	
X:XX	± 0.20	CHKD:	Huizhou Trxcom Electronics Co., Ltd.	
X:XXX	± 0.05	DR: GRANT	TITLE: Vertical RJ45 Connector with 1000 Base-TX Integrated Magnetics	
ANGLES	$\pm 1^\circ$	UNIT: mm	PART NO.: TRJD0720BENL	
	SCALE: 2/1	SHEET: 2/4	REV: A	DWG NO.: TRC15051411

REV.	ECN NO.	DESCRIPTION	DATE	APPD
A	REL		2015-05-14	

SUGGESTED PROFILE OF WAVE SOLDER FOR ROHS PRODUCT

REV: A
 TEMP(°C): 25
 HUM(%): 65 RH

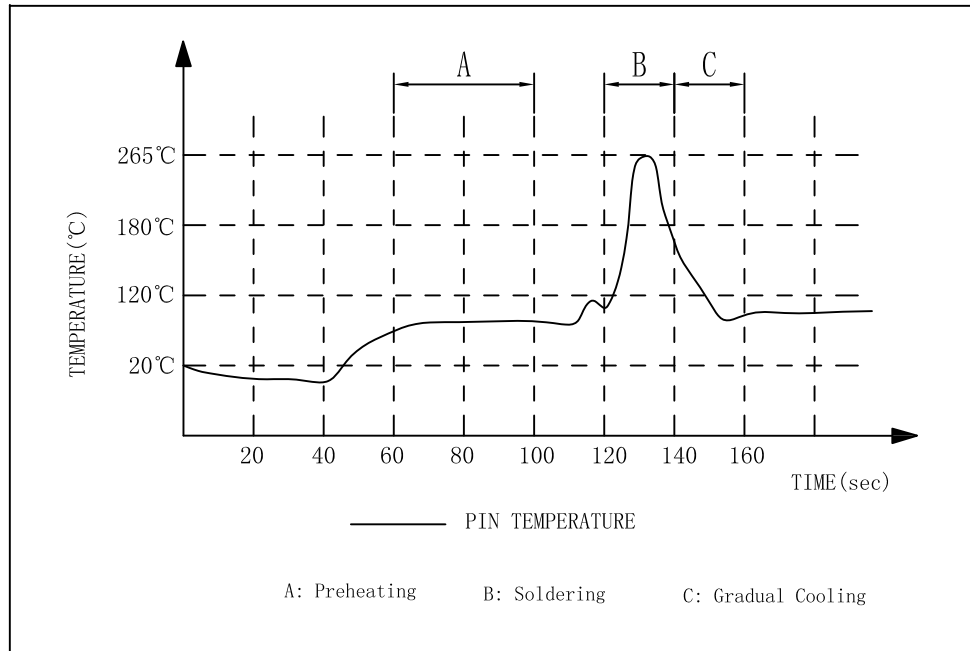

- (1) Tip Temperature: 265°C max
 - (2) Tip Temperature time: 5sec max
- Note: The melting point of Tin: 219°C

X:X ±0.25	APPD:	Trxcom
X:XX ±0.20	CHKD:	
X:XXX ±0.05	DR: GRANT	TITLE: Vertical RJ45 Connector with 1000 Base-TX Integrated Magnetics
ANGLES ±1°	UNIT: mm	PART NO.: TRJD0720BENL
	SCALE: 2/1	SHEET: 3/4
	REV: A	DWG NO.: TRC15051411

Packaging:

REV.	ECN NO.	DESCRIPTION	DATE	APPD.
A	REL		2015-05-14	

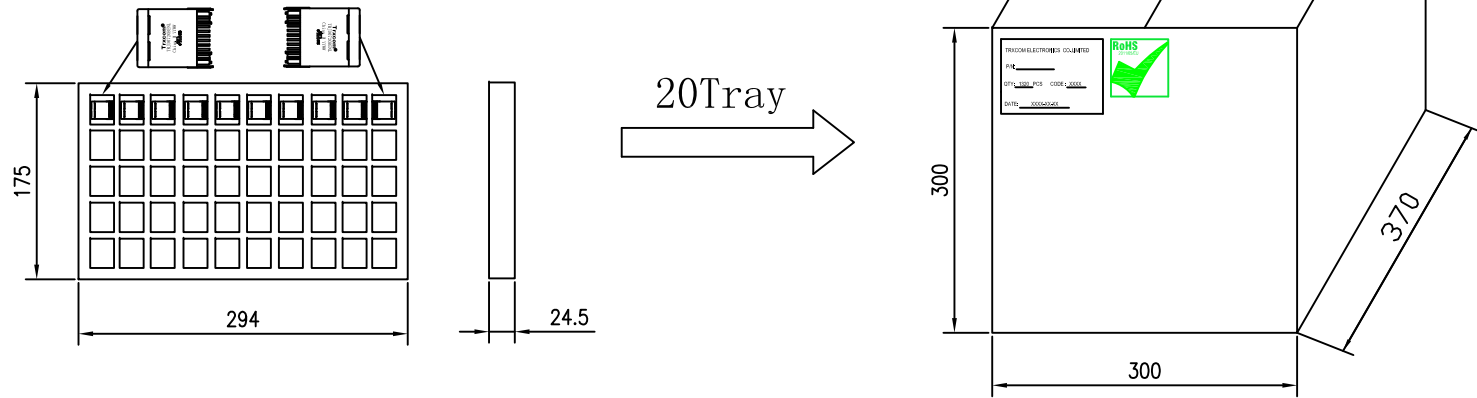

- ◆ Packaging unit :50pcs/tray
- ◆ Packaging material:PVC
- ◆ Outer carton unit:1000pcs/20tray/box
- ◆ Net Weight:7kg
- ◆ Gross Weight:9kg

X:X ±0.25	APPD:	Trxcom Huizhou Trxcom Electronics Co.,Ltd.
X:XX ±0.20	CHKD:	
X:XXX ±0.05	DR: GRANT	TITLE: 1*1 21.59 Vertical RJ45 PACKING
ANGLES ±1°	UNIT: mm	PART NO.: TRJD0720BENL
	SCALE: 2/1	SHEET: 4/4
	REV: A	DWG NO.: TRC15051411