

## Constant Current Dimmable Driver

Model:T42C300-1050N-X-4X



Model	Output Current (*Typical)	Input Current	Input Power	Output Power Range	PF	Efficiency	Output Voltage	No load Voltage
T42C300-1050N-X-4W T42C300-1050N-X-4B T42C300-1050N-X-4G	300mA	0.07A	15.4W	3.00-12.60W	0.86	85%	10-42V	59V
	350mA	0.08A	17.9W	3.50-14.70W	0.87	86%	10-42V	59V
	400mA	0.09A	20.5W	4.00-16.80W	0.88	87%	10-42V	59V
	450mA	0.10A	22.8W	4.50-18.90W	0.89	87%	10-42V	59V
	500mA	0.11A	25.3W	5.00-21.00W	0.90	87%	10-42V	59V
	550mA	0.12A	27.8W	5.50-23.10W	0.91	87%	10-42V	59V
	600mA	0.14A	30.4W	6.00-25.20W	0.92	89%	10-42V	59V
	650mA	0.15A	32.5W	6.50-27.30W	0.93	89%	10-42V	59V
	700mA	0.16A	35W	7.00-29.40W	0.94	90%	10-42V	59V
	750mA	0.17A	37.5W	7.50-31.50W	0.94	90%	10-42V	59V
	800mA	0.18A	40W	8.00-33.60W	0.95	90%	10-42V	59V
	850mA	0.18A	40W	8.50-34.00W	0.95	90%	10-40V	59V
	900mA	0.2A	42.4W	9.00-36.00W	0.96	90%	10-40V	59V
	950mA	0.2A	44.7W	9.50-38.00W	0.96	90%	10-40V	59V
	1000mA	0.23A	46.5W	10.00-40.00W	0.97	90%	10-40V	59V
1050mA	0.24A	48.8W	10.50-42.00W	0.97	90%	10-40V	59V	

\* Test result @230V, 50Hz, Full Load. Current setting @ 1mA-steps (NFC)

### 1. Parameters

Category	Item	Technical Norm
Features	Output Type	Constant Current
	Dimming Type	Bluetooth
	Output Features	Isolation
	IP Grade	IP20
	Insulation Class	Class II
Input	Rated Input Voltage	220-240VAC
	Range of Input Voltage	198-264VAC or 198-280VDC
	Frequency	50/60Hz
	Input Current	≤0.24A (230VAC, full load)
	Input Power	≤48.8W (230VAC, full load)



	Power Factor	≥0.95 (230VAC, full load)
	THD	≤15% (230VAC, full load)
	No-load Power Consumption	≤0.5W@230VAC
Output	Output Voltage Range	10-42VDC@300-800mA 10-40VDC@850-1050mA
	No Load Voltage	59VDC Max.
	Output Current	300mA -1050mA (Max. output)
	Max. Output Power	42W
	Efficiency	≥90% (230VAC, full load)
	Current Ripple	±5% (Imax-Imin)/(Imax+Imin)
	Current Accuracy	±5%
	Started Delay Time	≤0.5S (230VAC, full load)
	Protection	Short Circuit Protection
Overload Protection		Auto Recovery
No-load Protection		Auto Recovery
Insulation voltage		3000V 5mA 60S between P-S
Insulation resistance		>100M ohm @ 500VDC
Leakage current		< 250μA, I/P to O/P or I/P to PE @230V input
Environment	Ta/Operation Temperature	-20....+35°C
	Ts/Storage Temperature	-30....+85°C
	Tc/Enclosure Temperature	75°C
	Humidity	10%....90%RH
	Atmosphere	86-108KPa
Construction	Connection Method	Push-in Terminal
	Installation	Independent
	SEC Wire preparation	0.5-1.5 <sup>□</sup>
	Dimension	220*31*45mm (L*W*H)
Standards	Certification	CE
	Safety Standards	EN61347-1:2015,EN61347-2-13:2014/A1:2017, AS 61347.2.13:2018,AS/NZS 61347.1:2016 Inc A1
	EMC Standards	EN55015:2013/A1:2015,EN61000-3-2:2014, EN61000-3-3:2013,EN61547:2009
	Performance	EN62384
	Surge	L-N/2KV
Others	RoHS	complied to 2011/65/EU
	Life Time	50000h @Ta35°C
	Warranty	5years , F.R. < 10000ppm

Remark:

- All Parameters, if not specified, are measured at 230VAC/50Hz and 25°C ambient temperature.
- LED Driver is a component of the luminaires, Luminaires and wire layout will affect the EMC, please check the EMC with end products again.



## 2. Connected quantities of different current Breaker

TYPE	Connected quantities of different current Breaker						Input Voltage	Inrush Current (A)	Time
	current (A)	10	13	16	20	25			
	Installation wire diameter	1.5mm <sup>2</sup>	2.5mm <sup>2</sup>	2.5mm <sup>2</sup>	4mm <sup>2</sup>	4mm <sup>2</sup>			
TYPE B		9	12	15	18	23	@230VAC	65	200US
TYPE C		15	19	24	30	37			
TYPE D		24	31	38	47	59			

## 3. Label



Constant Current Lighting track adaptors  
For LED modules only  
Top side (NFC)) ↓

**LED Dimmable Driver**  
**T42C300-1050N-X-4W**  
PRI:220-240VAC 50/60Hz Max.0.24A  
SEC:300-1050mA 10-42VDC  
No Load:59VDC Max.42W Fmax.50N ↓  
ta:35°C tc:75°C

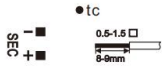





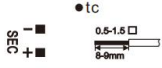

Constant Current Lighting track adaptors  
For LED modules only  
Top side (NFC)) ↓

**LED Dimmable Driver**  
**T42C300-1050N-X-4B**  
PRI:220-240VAC 50/60Hz Max.0.24A  
SEC:300-1050mA 10-42VDC  
No Load:59VDC Max.42W Fmax.50N ↓  
ta:35°C tc:75°C







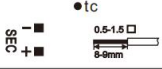

Constant Current Lighting track adaptors  
For LED modules only  
Top side (NFC)) ↓

**LED Dimmable Driver**  
**T42C300-1050N-X-4G**  
PRI:220-240VAC 50/60Hz Max.0.24A  
SEC:300-1050mA 10-42VDC  
No Load:59VDC Max.42W Fmax.50N ↓  
ta:35°C tc:75°C





CASAMBI X

WIFI+BLE X

ZigBee X

Matter X

Thread X

BLE X

## 4. IOT module list approved by KGP

1CH
CASAMBI
Matter WiFi
Matter Thread
WiFi+BLE
BLE
Zigbee



**5. Electrical values**

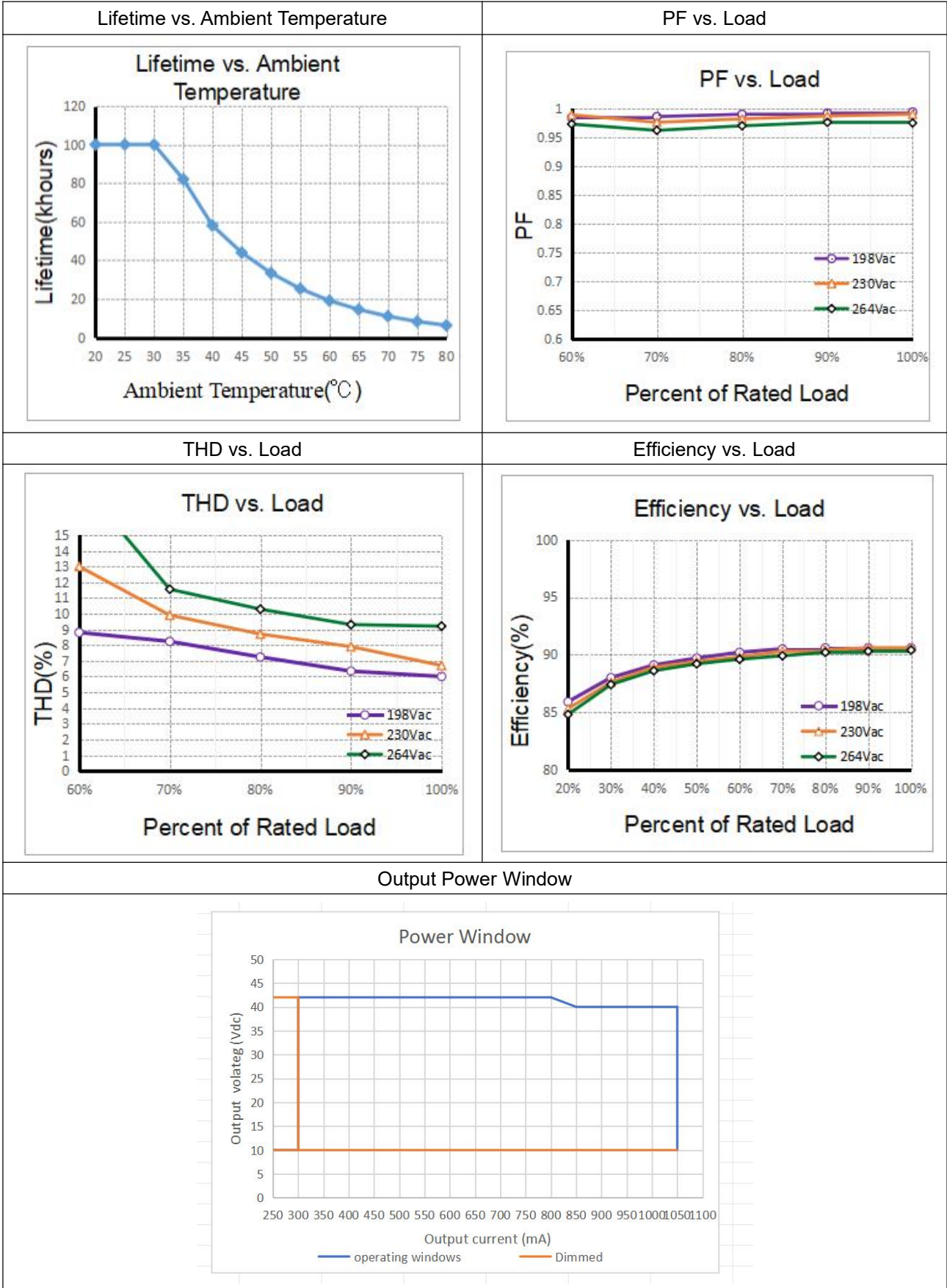

## 6. Dimension

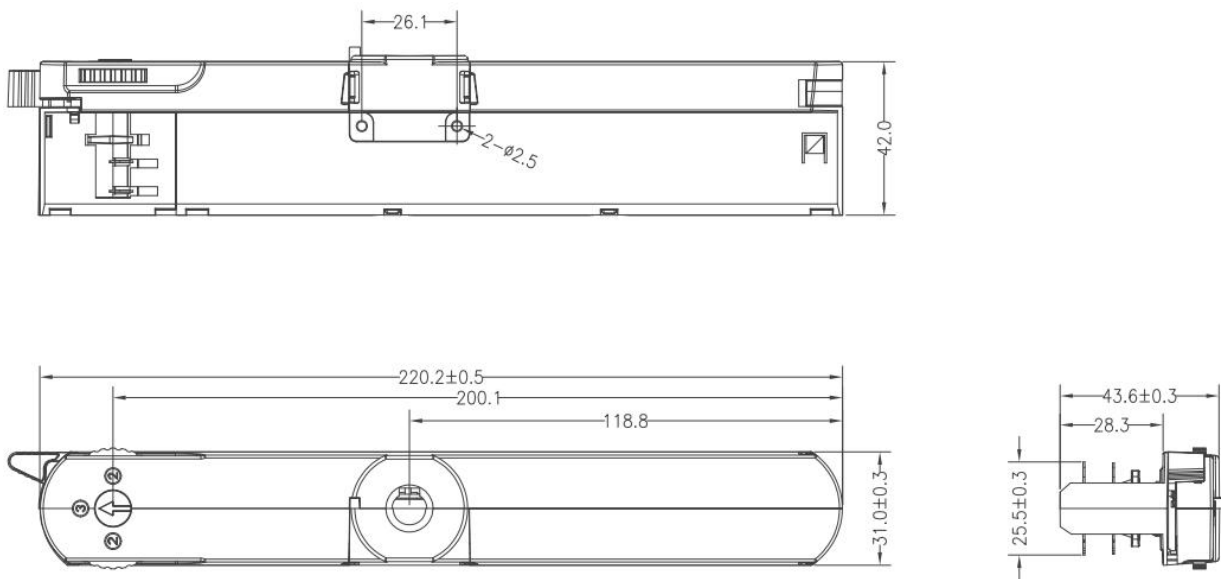

## 7. Packing information

Packing way	Model	Colour	Carton L*W*H(mm)	Pcs/ Carton	Net weight/ Pcs(kg)	Net weight/ Carton(kg)	Gross weight/ Carton(kg)
industrial	T42C300-1050N-X-4W	White	L420*W285* H220	40	0.145	5.8	7.1
	T42C300-1050N-X-4B	Black					
	T42C300-1050N-X-4G	Grey					

## 8. Wiring Diagram

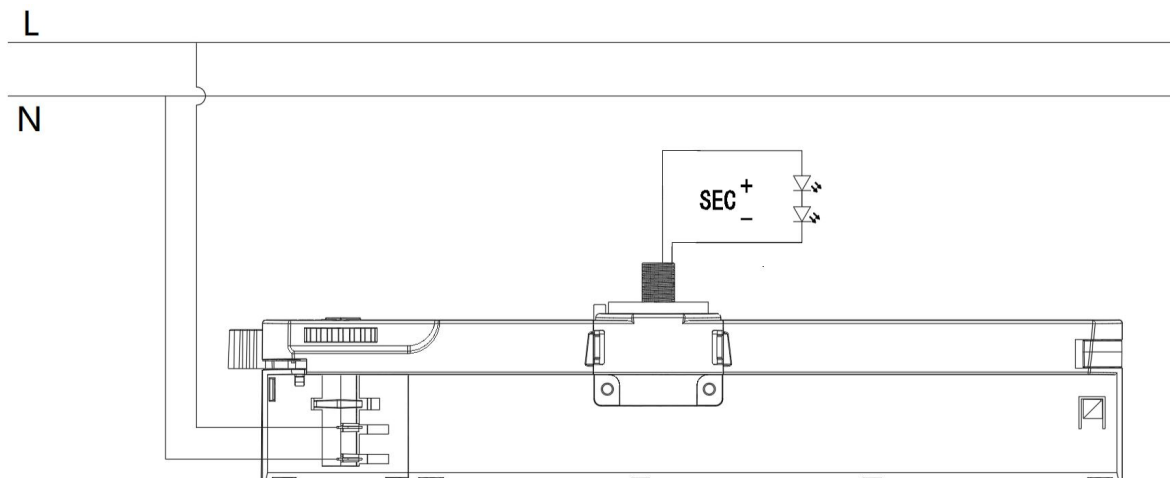

## 9. Lamp Screw Type

- Optional threaded sleeve for luminaire mounting
- Suitable for M10x1x8 threaded nut
- Additional mounting equipment, e.g. M10x1x12
- aluminium, black, white
- further on request

Type	Colour	Article number	Qty/ctn	Weight/pcs
M10x8	White	AL	PC	9.04
	Black	AL	PC	9.04
	Gray	AL	PC	9.04
M10x12	White	AL	PC	9.72
	Black	AL	PC	9.72
	Gray	AL	PC	9.72

## Ordering data

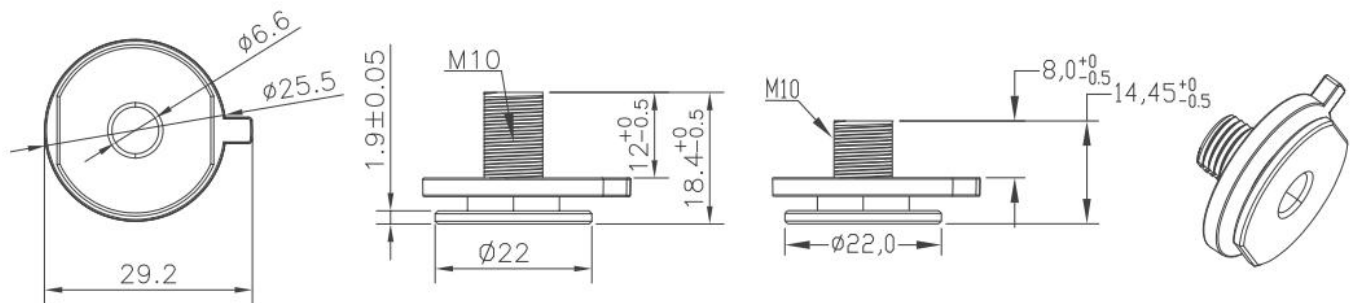

## 10. Suitable for following tracks

Serial number	Brand	Track model	System
1	Global	XTS11 & XTSC611	3P
2	A.A.G STUCCHL	9000-1-ST	3P
3	Eutrac	25-106	3P
4	Unipro	T32B	3P
5	PowerGEAR	Pro-0431L&Pro-D631R	3P
6	ERCO	1079301000	3P

### Remark:

1. The model name is XTS 4 and XTSF 4 tracks, and its brand is Global.
2. The model name used is the 9000-ST track, and its brand is A.A.G STUCCHL The "XX" in the model name represents: it represents a different color.
3. The model name is 2510x tracks, and its brand is Eutrac. The "x" in the model name represents: it represents a different color (x=1 white; x=2 black; x=3 silver, x=8 grey).
4. The model name is T32B tracks, and its brand is Unipro.
5. The model name is Pro0430 tracks, and its brand is PowerGEAR.
6. The model name is 1079301000 tracks, and its brand is ERCO.



## 11. Phase track light rail specification:

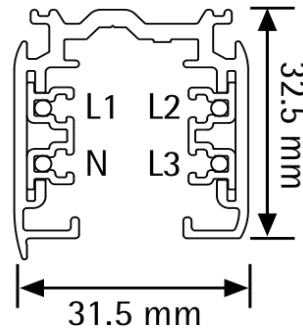

## 12. Wiring instructions

- All connections must be kept as short as possible to ensure good EMI behaviour
- Mains leads should be kept apart from LED Driver and other leads (ideally 5 – 10 cm distance)
- Advice the maximum length of output wires is 3 m
- Secondary switching is not permitted (Except for constant voltage)
- Incorrect wiring can damage LED modules.
- The wiring must be protected against short circuits to earth (sharp edged metals parts, metal cable clips, louver, etc.)
- Hot plug-in is not supported due to residual output voltage of > 0 V up to mains voltage. Danger to life.
- When connecting an LED load, restart the device to activate the LED output.

## 13. Earth connection

The earth connection is conducted as protection earth (PE). The LED driver can be earthed via earth terminal or metal housing. If the LED driver will be earthed, protection earth (PE) has to be used. There is no earth connection required for the functionality of the LED driver. Earth connection is recommended to improve following behaviour:

- Electromagnetic interferences (EMI)
- Transmission of mains transients to the LED output

In general it is recommended to earth the LED driver if the LED module is mounted on earthed luminaire parts respectively heat sinks and thereby representing a high capacity against earth.

## 14. Replace LED module

- Mains off
- Remove LED module
- Wait for 30 seconds
- Connect LED module again

Hot plug-in or secondary switching of LEDs is not permitted and may cause a very high current to the LEDs



## 15. NFC instructions

### REMARK:





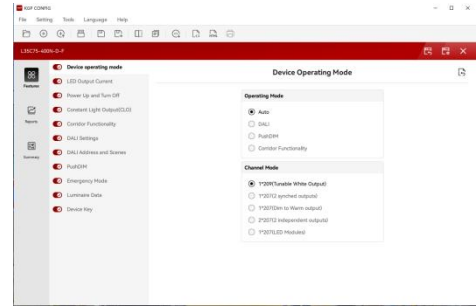

- (1) You are advised to set DALI parameters when the power supply is not enabled
- (2) Make sure your phone has NFC capability and has it activated.

### NFC Reader (optional)

#### Feature:

Easily on-line read a output current from a driver or write a new current data to a driver throughout KGP NFC reader within few seconds.



Product	Description	Interface	Matching antenna	
 ID CPR30+ Desktop programmer	USB	Integrated	Yes	Single Programming on Desktop
 ID ISC.PRH101-USB Handheld programmer	USB	Integrated	Yes	Single Programming by Handheld
 ID ISC.MR102-USB Middle range programmer , for connecting external antenna	USB	RF-MANT12786 	Yes	Single Programming on Product line
 ID ISC.LR1002-E Long range programmer , for connecting external antenna	USB,RS232,TCP/IP	ID ISC.ANT310/310 	Yes	Multi Programming System

## 1. Import database file



Click the "Tools" field and select "Import ECG Library" to import the ECG database

### Recent use files

C:\Users\kg6407\Desktop\KGP-TOOLS\烧录文件\SC42W.kgcf



## 2. Connect FEIG reader

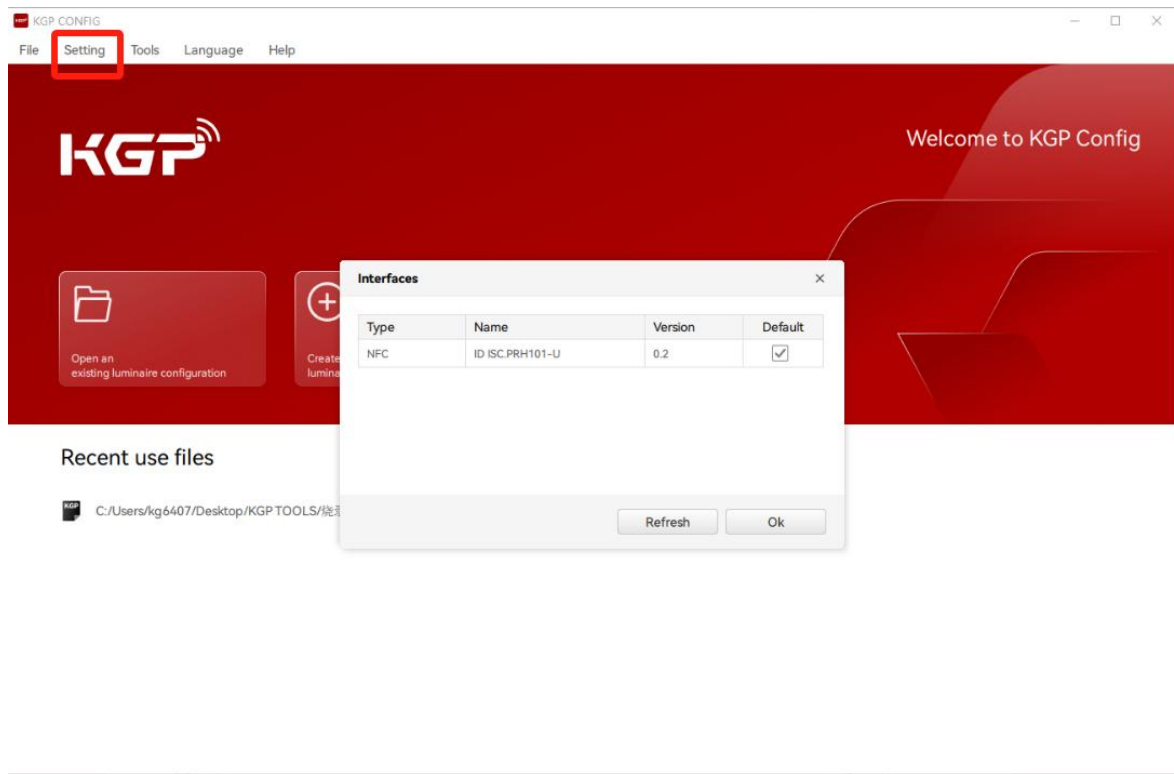

Click the "Setting" button to check whether the NFC port is connected

## 3. Read product information



Click this button to read



**4. You can choose to set the output current according to your needs**

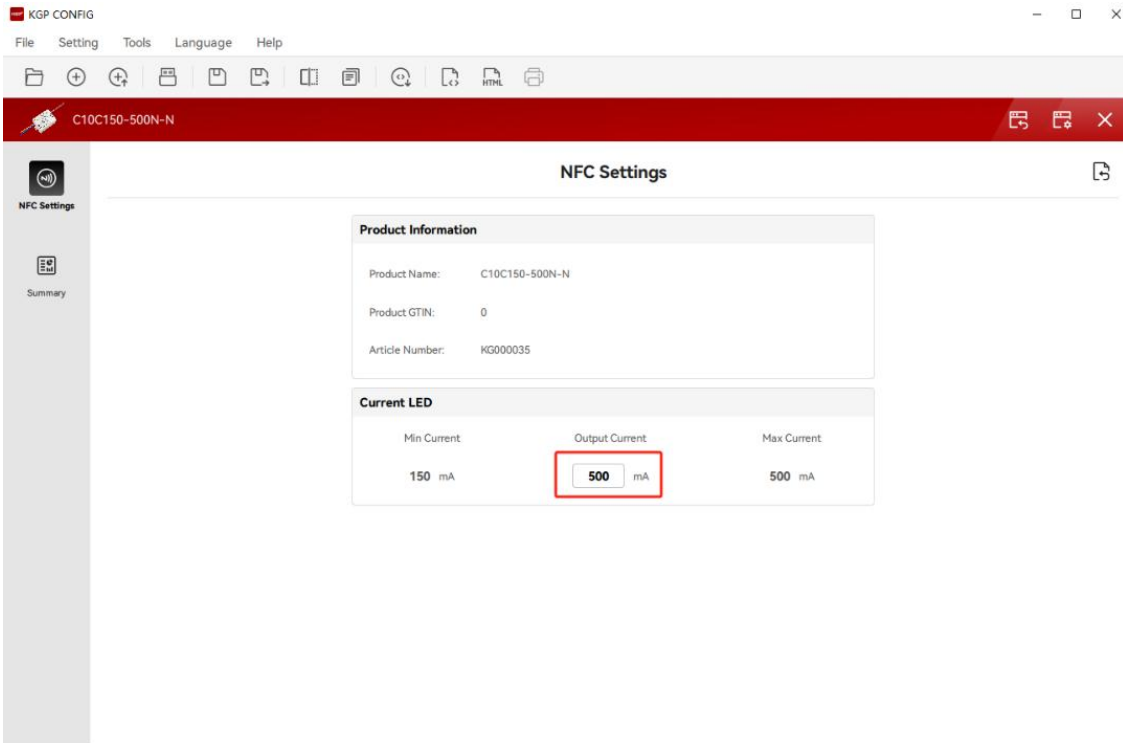

Enter the Output current value you want to change in the inputbox

**5. After the modification is complete, the download configuration page is displayed**

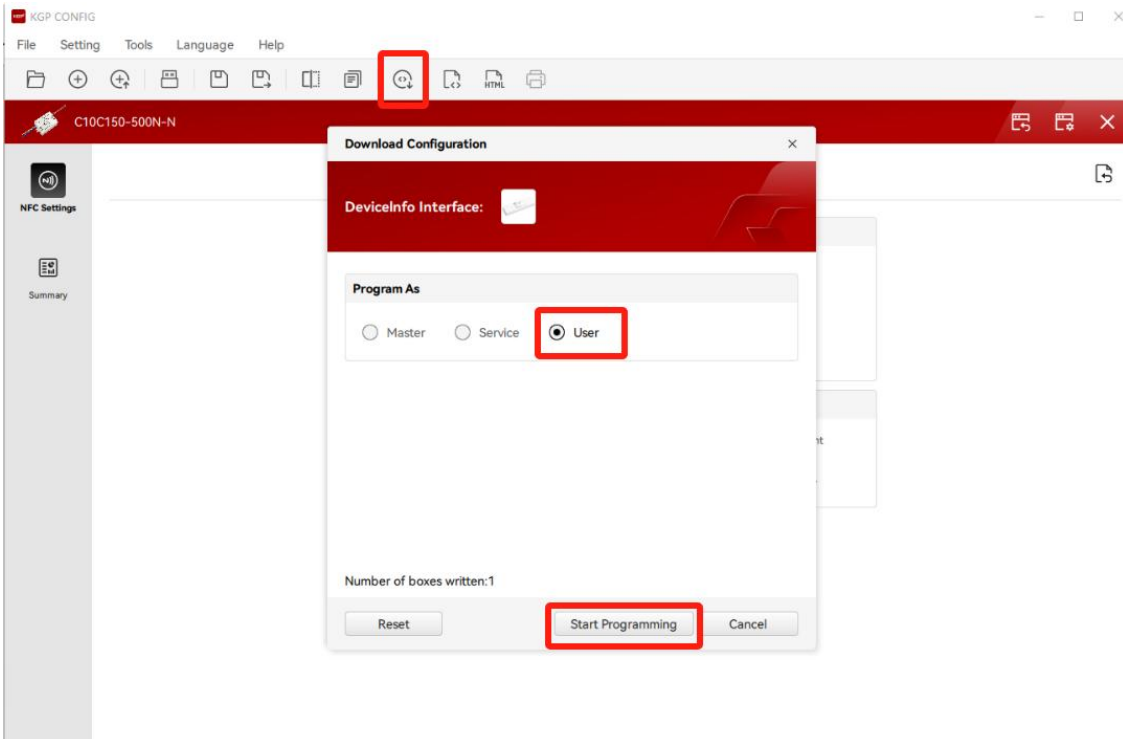

Click this button to enter the "Download Configuration" window, select the "User" option box, and click the "Start Programming" button for the next step



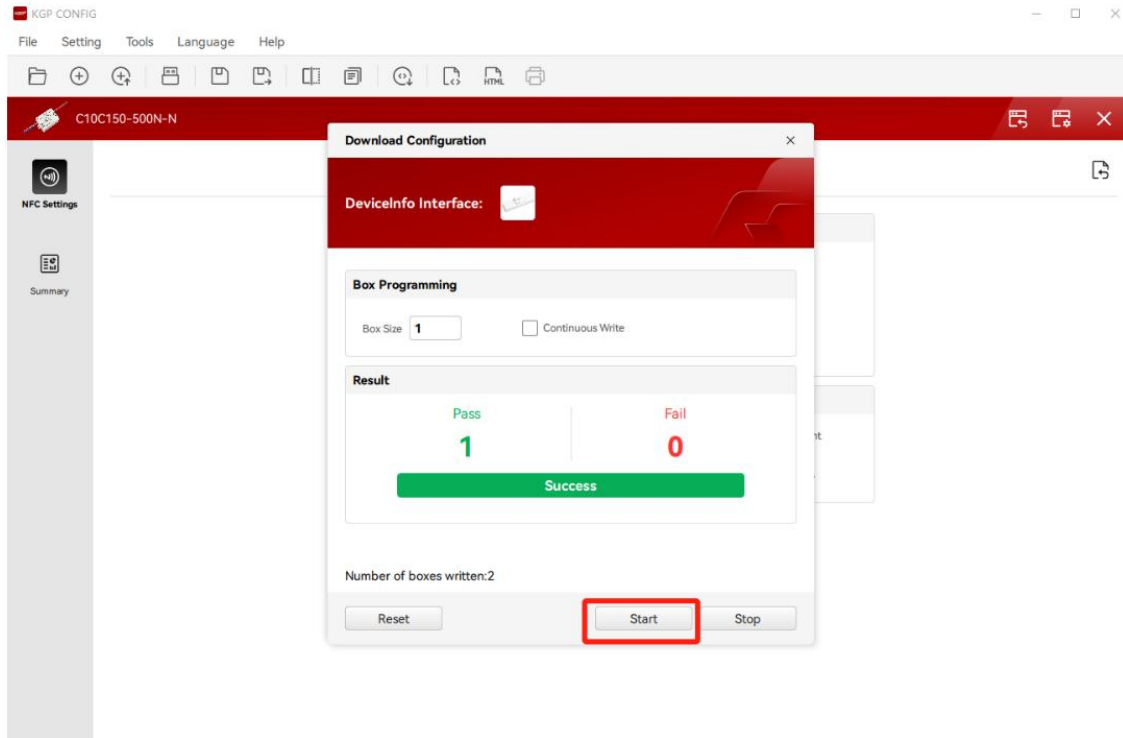

Click the "Start" button to program

**mobile client:**

**Note:**

1. Please Make sure that you have enabled NFC function with your mobile phone/ tablet.
2. Please Make sure that the "NFC position" is matched.
3. Please do not power on the device before setting.

**Step 1: Download the APP ,Then open the APP**



### Step2:Import database file

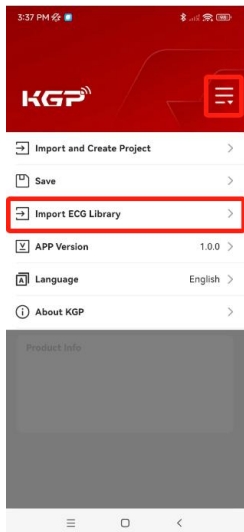

Click the drop-down box above, select "Import ECG library", then import the db database file

### Step3:Read product information

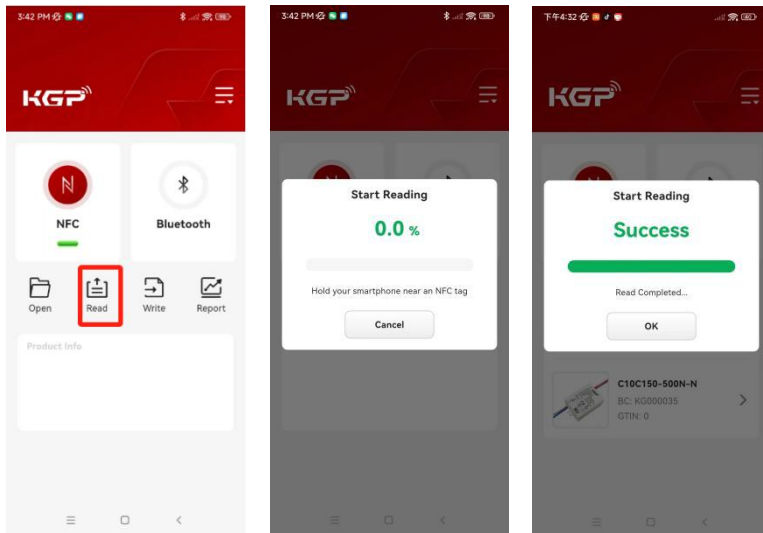

**Step4: You can choose to set the output current according to your needs, then write the configuration, and power on the device**

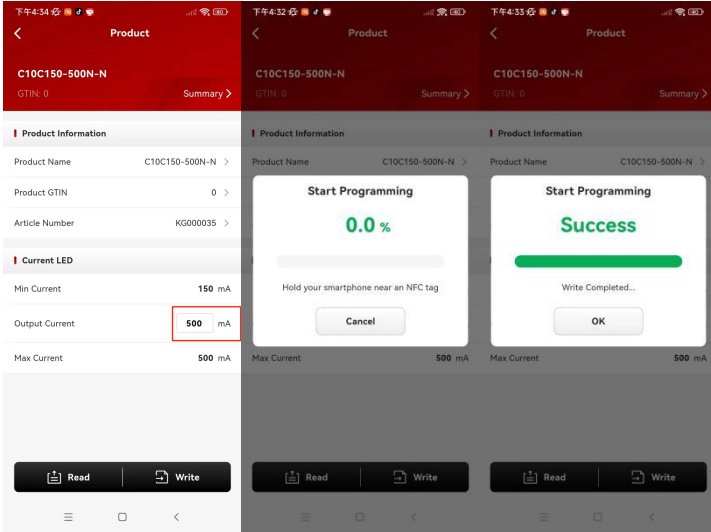

**Tips:**

- 1.NFC function doesn't require any power driver.
2. Many functions can be configured by NFC.Kindly check your desired functions.

**16. REVISION HISTORY**

DATE	REV	Modification details
2023-03-18	V1.0	Initial release.

