

Description

S6-1K2Y500 series is specially designed for sports Lighting and industrial lighting applications. It is constant current LED driver that operates from 220-400Vac with DMX&DALI-2 programming dimming function. This Rectangle integrated structure enables it to have a better heat dissipation cooler, significantly improving reliability and extending product life. To ensure trouble free operation, protection is provided against input surge, output over voltage, short circuit, and over temperature. The better thermal design and high efficiency enable the driver to operate with high reliability, and extending product lifetime. Overall protection is provided against lightning surge, output over voltage, short circuit, and over temperature, to ensure low failure rate.



Product Features

- Input voltage range: 198~440Vac;
- Constant current design;
- DMX-RDM control optional, Support RDM control mode & controller address setting;
- Support flashing function with maximum of 6 flashes per second;
- Non-Isolated Class I Driver;
- Efficiency up to 97%;
- 2*600W channels independently output;
- DMX&DALI-2 control interface;
- Dim-to-off; No glow after Dim-to-off;
- Max remote distance 300 meters;
- Surge protection: 10KV line-line, 10KV line-earth @ 2Ω;
- Multiple protection: SCP, OVP, OTP;
- IP66, IK08 design for indoor and outdoor applications;
- 5 years warranty.

Application

Stadium lighting
Area and flood lighting
High-bay lighting

Models

Model Number	Input Voltage Range(Vac)	MAX Output Power(W)	Output Voltage Range(Vdc)	Full Power Output Current Range(Vdc)	Default Current(A)	Eff.(Typ.)	PF(Typ.)	THD(Typ.)
S6-1K2Y500	198-440	1200W (600W x2)	260-500	(1.2~1.8A)*2	1.50A *2	97%	0.95	6%

NOTES:

[1]. Y=D means DALI-2, Y=R means DMX-RDM.

[2]. All specifications are measured at 25°C ambient temperature, input voltage 400Vac, and the typical value tested at full load, if no specific note.

Input Specifications

Parameter	Min	Typ.	Max	Notes
Input Voltage Typ.	220Vac	230/277/347/400Vac	400Vac	
Input Voltage Range	198Vac	-	440Vac	Refer to Output Power vs. Input Voltage curve
Input Frequency AC	47Hz	50/60Hz	63Hz	
Max Input Current	-	-	6.0A	220Vac&Full Load
Max Input Power	-	-	1300W	220Vac&Full Load
Protective Conductor Current	-	-	3.5mA	220~400Vac/60Hz;IEC 60598-1;
Inrush Current	-	0.8A ² S	1.0 A ² S	400Vac, full load,50%~50% peak pulse duration
Inrush Current	-	30A	35A	400Vac&Full Load, Cold Start
Power Factor(PF)	0.97	0.99	-	220-277Vac, 50/60Hz, 100% Load
Power Factor(PF)	0.93	0.95	-	347Vac, 50/60Hz, 100% Load
Power Factor(PF)	0.92	0.94	-	400Vac, 50Hz, 100% Load
Power Factor(PF)	0.95	0.97	-	220-277Vac, 50/60Hz, 80% Load
Power Factor(PF)	0.92	0.94	-	347Vac, 50/60Hz, 80% Load
Power Factor(PF)	0.91	0.93	-	400Vac, 50Hz, 80% Load
Total Harmonic Distortion(THD)	-	5%	15%	220-400Vac, 50/60Hz, 100% Load
Total Harmonic Distortion(THD)	-	10%	20%	220-400Vac, 50/60Hz, 70%-100% Load
MCB(B16)	-	3	-	220Vac

Output Specifications

Parameter	Min	Typ.	Max	Notes
Output Voltage Range	260Vdc	-	500Vdc	The full power cannot be lower than 333Vdc
Open Circuit Voltage	-	-	600Vdc	
Output Current range	0%	-	100% I _{max}	Dim to off without afterglow
Output Current range	0.70A	-	1.80A	Programmable current range by DALI / DMX programmer
Full Power Current Range V1+/V-	1.20A	-	1.80A	Common negative pole
Full Power Current Range V3+/V-	1.20A	-	1.80A	Common negative pole
Current Accuracy	-3%	-	+3%	
Total Output Current Ripple (pk-pk)	-	1%	1.5%	20MHz BW, full load& LED load, the ripple would be tiny different under different LED load.
Startup Overshoot Current	-	-	-	No overshoot.
Line Regulation	-1%	-	+1%	25°C±10°C ambient temperature, input voltage changes from 220Vac to 400Vac.
Load Regulation	-1%	-	+1%	25°C±10°C ambient temperature, Input Voltage 400Vac, load changes from 80% to 100%.
Turn-on Delay Time	-	-	1.5s	220~400Vac & 100% Load, load is LED

General Specifications

Parameter	Min	Typ.	Max	Notes
Efficiency@220Vac	94.0%	95.5%	-	Measured at full load and 25°C ambient temperature
Efficiency@277Vac	94.5%	96.0%	-	Measured at full load and 25°C ambient temperature
Efficiency@347Vac	95.0%	96.5%	-	Measured at full load and 25°C ambient temperature
Efficiency@400Vac	95.5%	97.0%	-	Measured at full load and 25°C ambient temperature
Mean Time Between Failure	-	200Khours	-	25°C±10°C ambient temperature, 220Vac, 80% load (MIL-HDBK-217F/SR-332)
Lifetime	-	50Khours	-	Tc=75°C, 220Vac&100% load
Ambient Temperature Ta	-40°C	-	+45°C	220Vac&100% load,
Ambient Temperature Ta	-40°C	-	+50°C	277Vac~400Vac&100% load,
Operating Tc for Safety Tc_s	-40°C	-	+90°C	
Operating Tc for Warranty Tc_w	-40°C	-	+75°C	5 years warranty case temperature Humidity: 10% to 80% RH No condensation
Storage Temperature Ta	-40°C	-	+85°C	
Altitude	-60m	-	4000m	
Input Under voltage Protection	150Vac	170Vac	190Vac	
External NTC (R1)	-	18K Ohm (Set by software)	-	When the R-NTC is reduced to R1, the external thermal protection is triggered and the output current gradually decreases.
External NTC (R2)	-	9.1K Ohm (Set by software)	-	When the R-NTC is reduced to R2, the output current is reduced to the programmed protection current value.
External NTC (Protection Circuit)	10%Io _{set}	60%Io _{set}	100%Io _{set}	10%Io _{set} >Io _{min} (Default setting 60%)
External NTC (Protection Circuit)	Io _{min}	60%Io _{set}	100%Io _{set}	10%Io _{set} ≤Io _{min} (Default setting 60%)
Over Temperature Protection Tc	-	90°C	95°C	Tc; 220Vac&100% load
Short Circuit Protection	-	-	-	Self-recovery
Dimensions (L*W*H)	500*150*81mm			
Net Weight	6400±100g/PCS			
Package (L*W*H)	587*487*170mm; 2PCS/ctn, Gross Weight: 15Kg			

DMX Dimming

Parameter	Min	Typ.	Max	Notes
DMX+ to DMX-	-6V	-	6V	
DMX+ to Chassis	22M Ohm	-	-	At 42Vdc
DMX- to Chassis	22M Ohm	-	-	At 42Vdc
Logic 0 Input	-	-	-0.2V	DMX+ to DMX-
Logic 1 Input	0.2V	-	-	DMX+ to DMX-
Communication Baud Rate	-	250K bps	-	
Dimming Output Range	5% I_{Omax}	-	100% I_{Oset}	
Dimming value with turn off	-	-	1	5% I_{Omax}
Dimming value with turn on	-	-	0	
flashing times per second	-	-	6	0%-100% I_{set}

Note:

All specifications are typical at 25°C.

DALI-2 Dimming

Parameter	Min	Typ.	Max	Notes
High Voltage Level	9.5V	16V	22.5V	
Lower Voltage Level	-6.5V	0V	6.5V	Return terminal is "DA-".
Dimming Output Current Range	5% I_{max}	-	100% I_{max}	$I_{max}=1.8A$.
Sink Current	-	-	2.0mA	
Timer dimming	-	-	-	Traditional, Self-adaption.
Output lumen compensation	-	-	-	Constant lumen output function.

Safety Specification

Parameter	CCC	CE/ENEC/SAA	UL	Notes
Dielectric Strength (Input-Ground)	2200Vac	2200Vac	2200Vac	60s, Current not exceeding 10mA
Dielectric Strength (Output-Ground)	2200Vac	2200Vac	2200Vac	60s, Current not exceeding 10mA
Dielectric Strength (Input-Dim)	5150Vac	4400Vac	2200Vac	60s, Current not exceeding 10mA
Grounding Resistance	0.1Ω(Max)			25°C±10°C Ambient Temperature, pass 25A Current, 60s.
Insulation Resistance	10MΩ(Min)			Input-PE, Output-PE, 500Vdc/60s/25°C/70%RH

Safety Compliance

Safety Category	Standards	Approved	Notes
CCC	GB19510.1,GB19510.14	√	
CE	EN61347-1, EN61347-2-13	√	
CE	EN62493	√	
ENEC	EN62384	√	
CB	IEC61347-1, IEC61347-2-13	√	
BIS	IS 15885(PART 2/SEC 13)	√	
UL	UL 8750	√	
CUL	CSA C22.2 No.250.13	√	
KC	K61347-1, K61347-2-13		
PSE	J61347-1, J61347-2-13		
SAA	AS/NZS IEC 61347.2.13	√	
SAA	AS/NZS 61347.1	√	

EMC Compliance

EMC Category	Standards	Approved	Notes
CCC	GB/T 17743, GB 17625.1	√	
CE	EN 55015	√	
CE	EN 61000-3-2, EN 61000-3-3	√	
CE	EN61000-4-2,3,4,5,6,11	√	
CE	EN 61547	√	
KC	K61547		
KC	K00015		
PSE	J55015		
FCC	FCC part 15	√	

RoHS

Our products comply with RoHS Directive (EU) 2015/863 amending Annex II to Directive 2011/65/EU.

Inrush Current

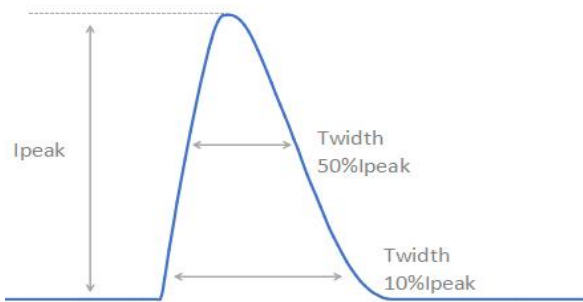

Vin	Ipeak	T(@10% of Ipeak)	T(@50% of Ipeak)
220Vac	20A	3.50ms	1.32ms
277Vac	24A	3.48ms	1.52ms
347Vac	30A	4.32ms	1.95ms
400Vac	32A	2.70ms	0.82ms

Output Voltage vs. Output Current

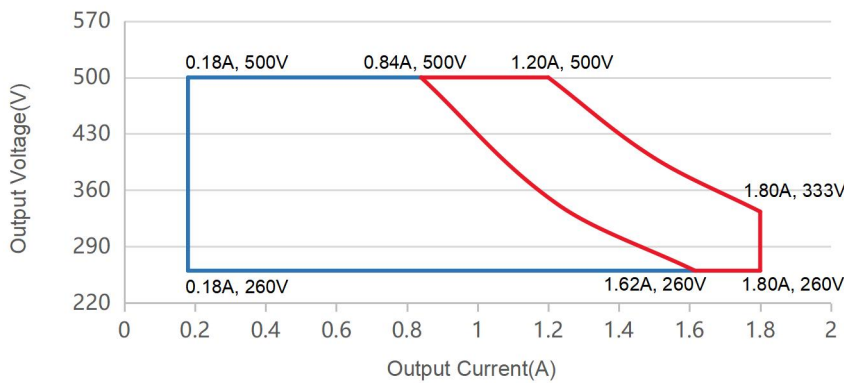

Red curve: good performance area

Output Power vs. Input Voltage

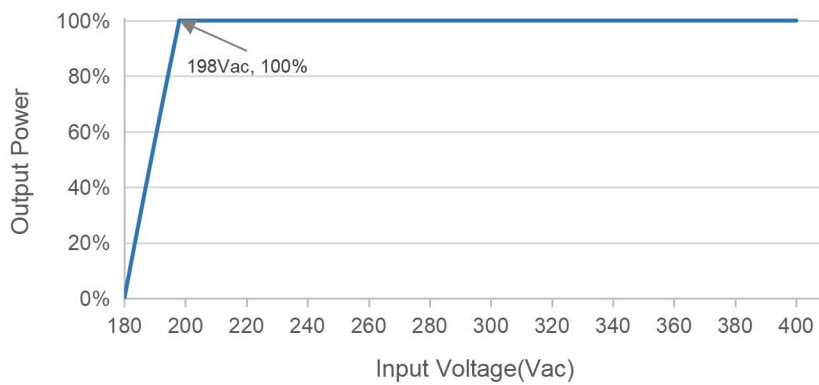

Efficiency vs. Load

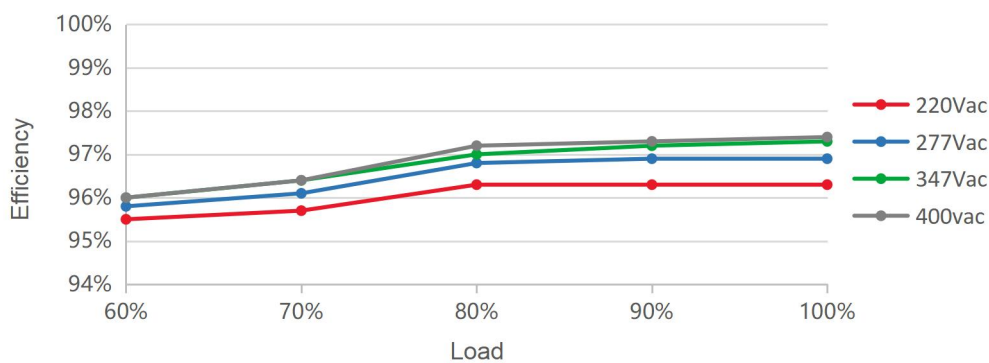

PF vs. Load

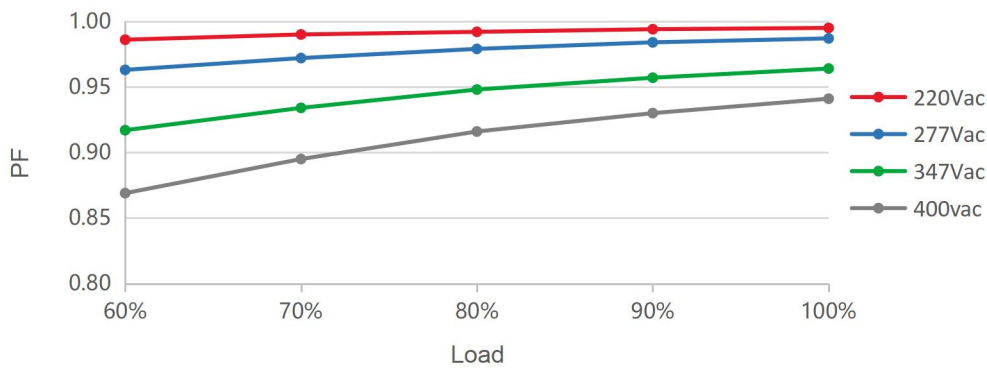

THD vs. Load

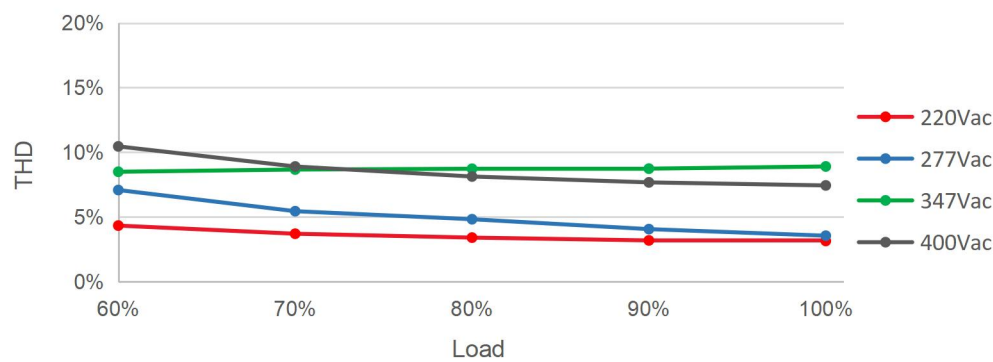

Output Power vs. Ambient Temperature

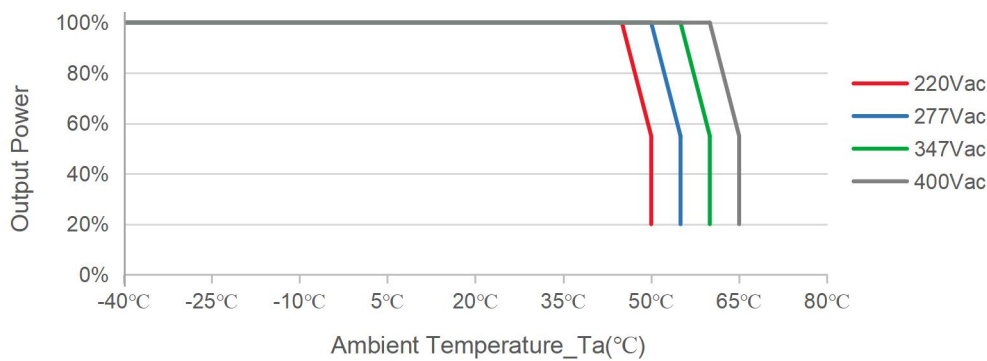

Lifetime vs. Case Temperature

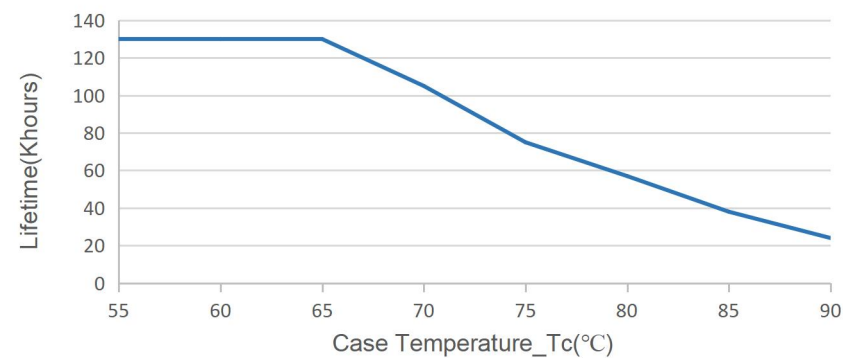

DMX Dimming Curve

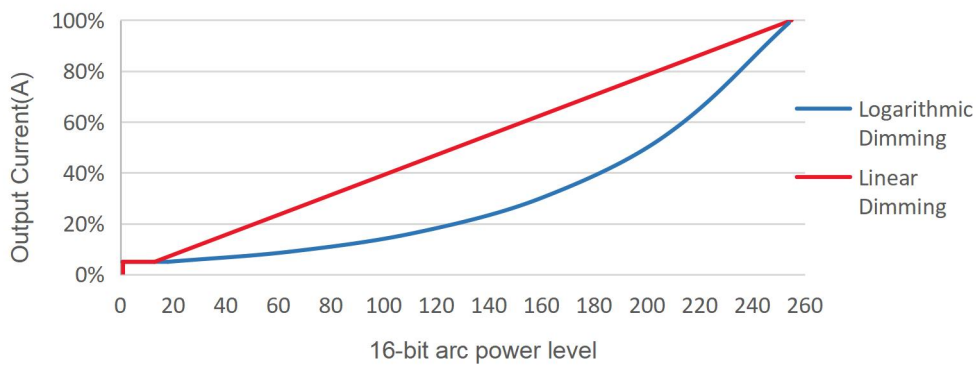

DALI-2 Dimming Curve

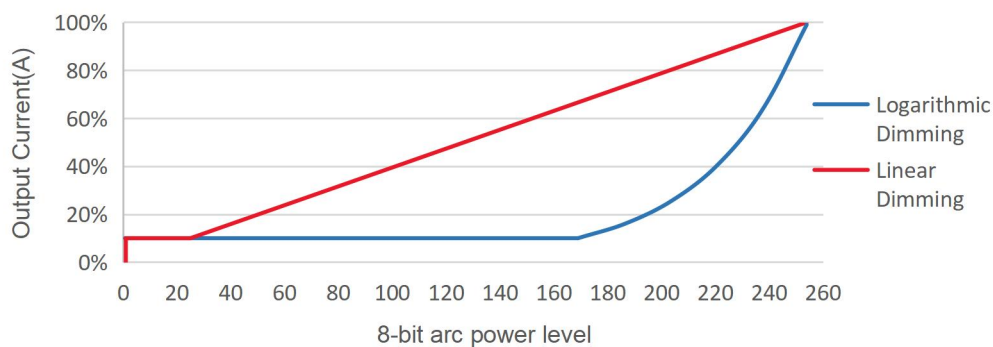

Note: Factory Default Output Logarithmic Curve.

Implementation: DMX512 Daisy chain

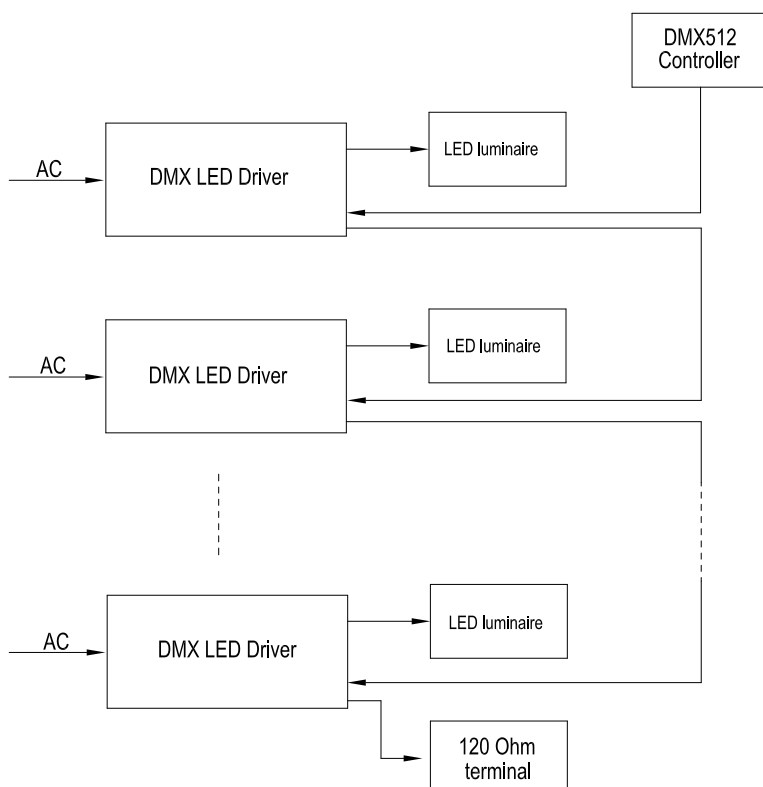

Note:
 [1]. Up to 32 drivers may be daisy-chained, terminated by a 120 Ohm resistor (connected between DMXA & DMXB as the last driver).
 [2]. 300m maximum length.
 [3]. 100m maximum between drivers.
 [4]. For best performance, a characteristic impedance of 120 Ohm should be maintained for the entire length of the control wire.

Programming Connection (DMX&DALI-2)

■ For Dali

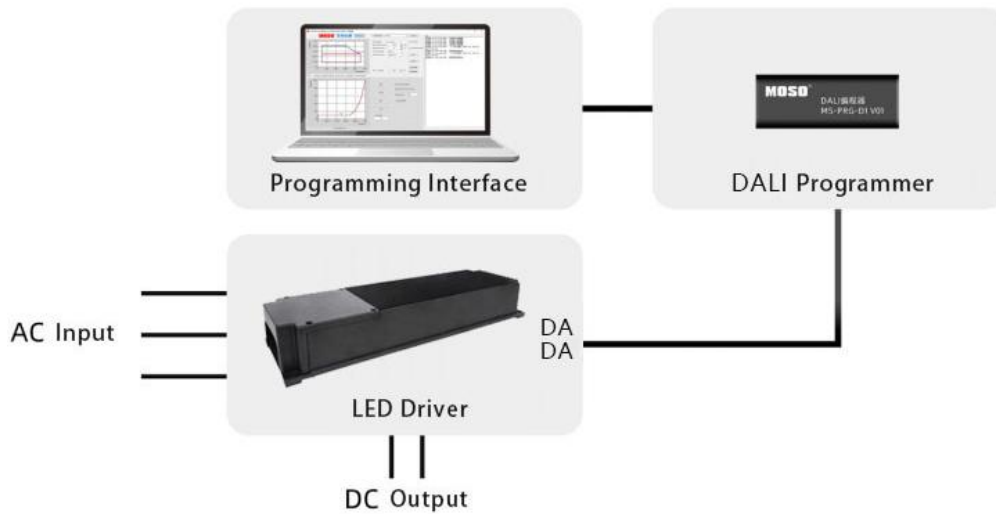

■ For DMX

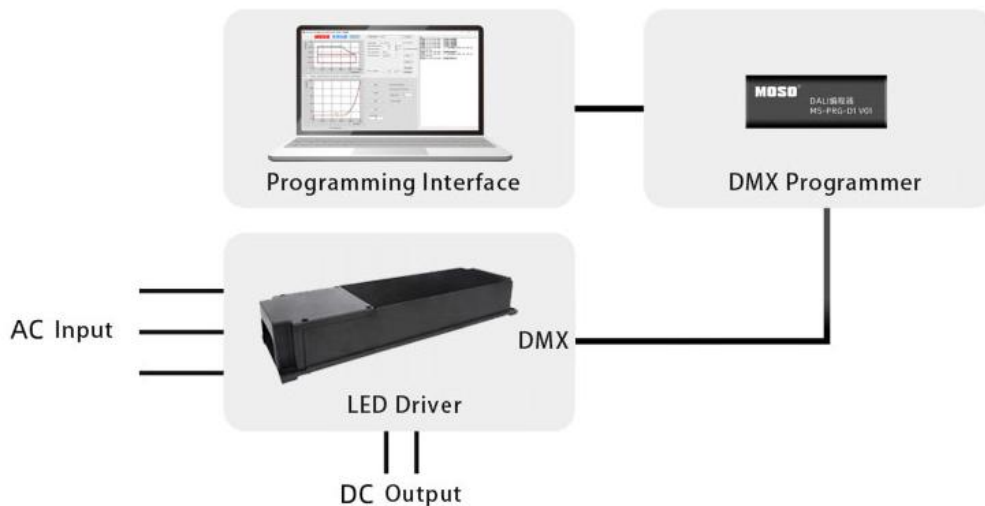

1. Dimming Mode Switching for DALI-2 & DMX-RDM

1.1 Switching from DALI-2 Dimming to DMX-RDM:

- After connecting the DMX programmer to computer, click on the software "Scan Port" button;
 - Click "Read Cfg" to import the corresponding model's DMX configuration file (Six .cfg files for S6-1200W/1500W/1800W will be provided in advance by MOSO);
 - Click 'Set' button to transmit the .cfg file into the driver's MCU;
 - After setting and restarting the driver, the software interface displays the DMX dimming mode, indicating successful conversion;
- Note: If the third step fails to set, select "FFFFFFFFFFFF" for the Device UID and reset the driver.

1.2 Switching from DMX-RDM to DALI-2 Dimming:

- After connecting the DALI programmer to computer, click on the software "Scan Port" button;
- Click "Read Cfg" to import the corresponding model's DALI configuration file (Six .cfg files for S6-1200W/1500W/1800W will be provided in advance by MOSO);
- Click 'Set' button to transmit the .cfg file into the driver's MCU;
- After setting and restarting the driver, the software interface displays the DALI-2 dimming mode, indicating successful conversion;

2. Operating instructions

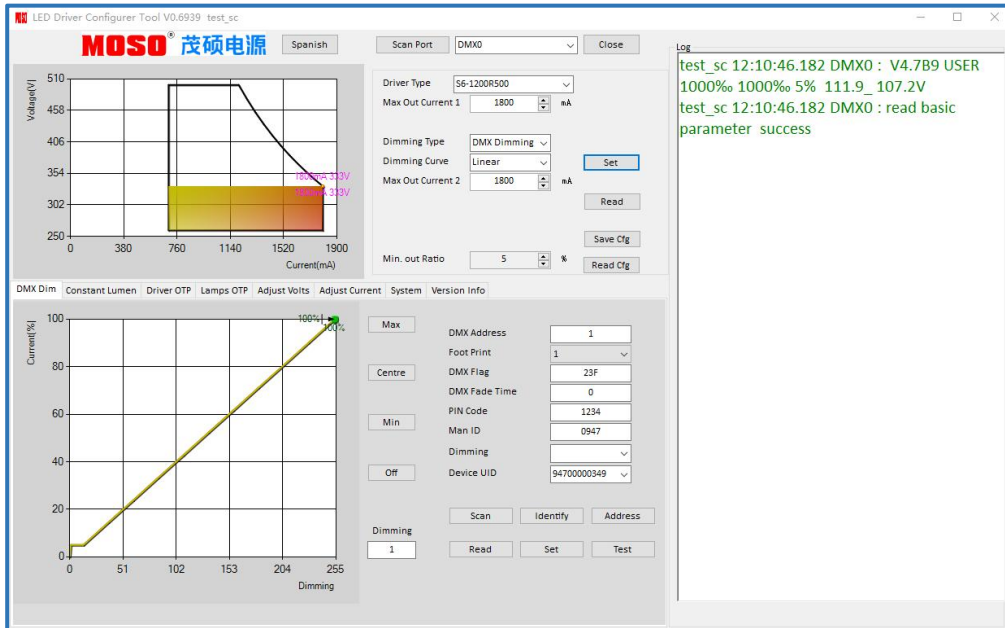

DALI / DMX visual software programming

1. Use corresponding programmer to connect with driver.
2. The output current of the two channels is independent. When setting the current, each channel needs to be modified.
3. The current parameters and configured driving parameters can be read and set.
4. Time dimming. Set the timing control function, which supports 7 segments.
5. Driver OTP and Lamps OTP. The Driver OTP and Lamps OTP parameters can be set according to the needs of customers.

3. NTC

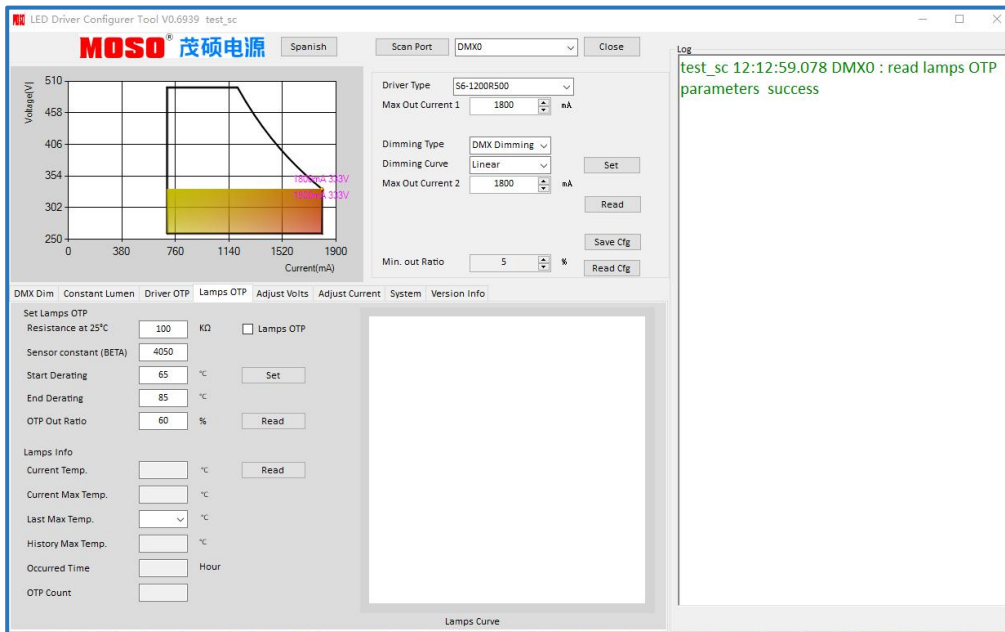

The recommended value of NTC resistance is 100KΩ, BETA: 4050

NTC resistance value changes with temperature:

40°C	48.6KΩ-58.8KΩ;
60°C	21.8KΩ-26.3KΩ;
65°C	18.1KΩ-22.1KΩ;
70°C	15.1KΩ-18.6KΩ;
75°C	12.7KΩ-15.8KΩ;
80°C	10.7KΩ-13.4KΩ;
85°C	9.1KΩ-11.5KΩ;

4. DMX interface parameters

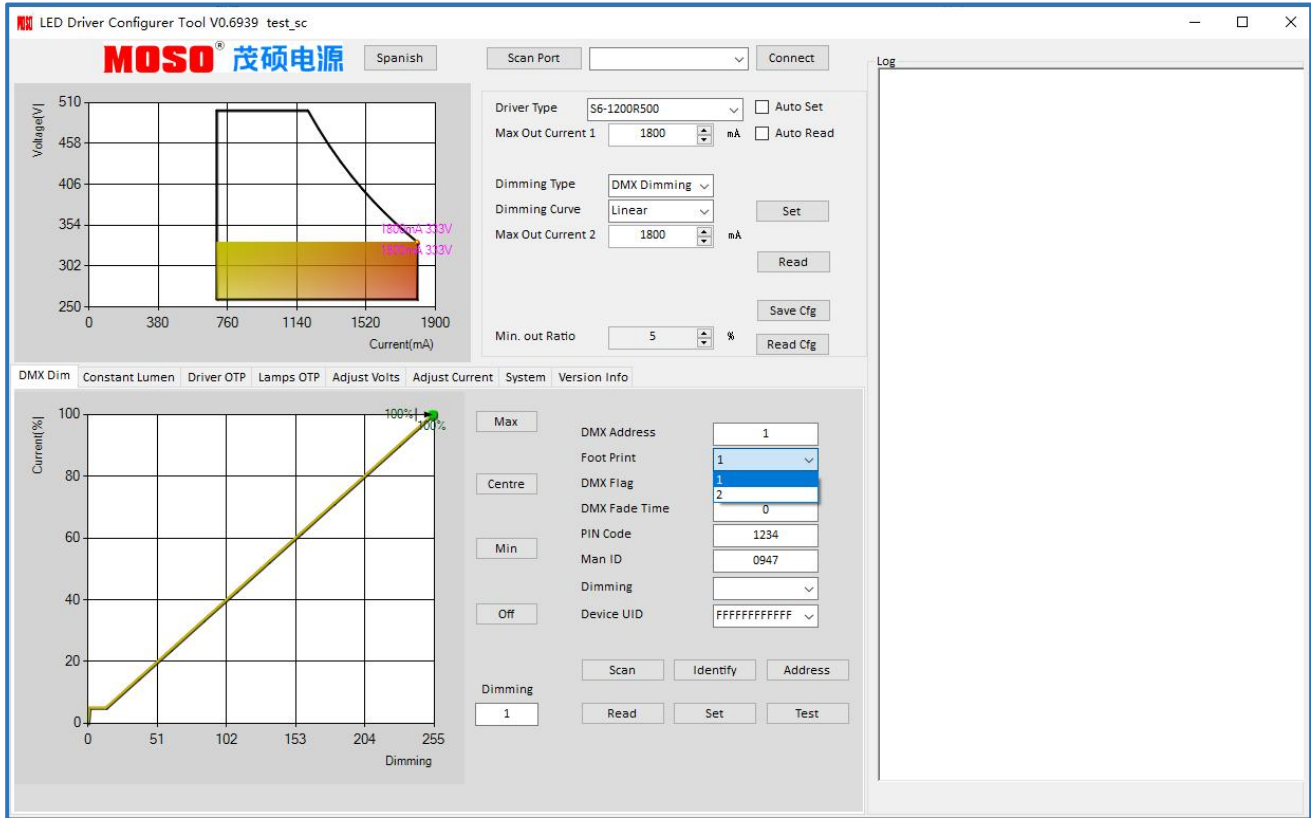

◆ Scan

When the DMX control system is connected to a new driver, customer need to click the “Scan” button to scan the new driver. The Configurer Tool will automatically read the Device UID of the newly connected driver in the system, The UID of the driver is displayed on the right LOG page. When the Device UID displayed by the Configurer Tool is consistent with the actual device UID of the driver, you can perform the next operation on the DMX driver, otherwise the software will display "read basic parameter fail".

◆ Identify

The specific position of the driver can be identified by this function. Click the “Identify” button, and the light connected to the corresponding driver will flash to indicate its location.

◆ Foot print

This function is used to assign the number of addresses. If 1 is selected, the two channels share a single DMX address, and if 2 is selected, the two channels use two different DMX addresses.

◆ Address

Driver assignment DMX address can be modified. With this function, customer can enter any number within 512 into the “DMX Address” to reassign the DMX address of a driver. Entering the number, then click “Address” to complete the address setting.

The number of driver channels corresponds to the number of DMX addresses occupied by the driver. The Address window displays the address of the first channel. For example, if the address of the first channel is 6, the address of the second channel is 7.

⚠ Note: So for multichannel DMX drivers, the maximum configurable address equals : 512- (number of channels) +1, Unlike the “Address” button, which can

only modify the DMX address of the driver, “Set” can set all the DMX parameter modified by customer into the driver.

◆ DMX Flag

The software displays the hexadecimal code and converts the corresponding binary code to correspond to functions. 1 indicates that the function is enabled and 0 indicates that the function is disabled. At present, only ten functions are supported.

For example, 23F=10 ,0011 ,1111 indicates that functions 0~5 and 9 are enabled.

◆ Dimming

This function is used to read the dimmer value data of the driver in real time and return the value.

◆ DMX fade time

The Fade Time will be started when the system changes the dimming value. The maximum of Fade Time for each steps can reach 2500ms, The calculation method is set value multiplied by 10ms.

The longest total time spent will be 635 seconds when dimming value has changed from 0 to 254 with maximum Fade Time. The calculation formula is as follows:

$$255 \text{ steps (whole dimming value has changed)} * 2500\text{ms (maximum fade time)} \div 1000 \text{ (Unit conversion: from microseconds to seconds)} = 635 \text{ seconds.}$$

◆ PIN Code

The password for each driver to join the customer’s control system.

◆ Device UID

A window used to select the device UID of the driver. Use the “Scan” button to automatically switch the device UID of the driver newly connected to the system, or manually select the device UID previously connected.

Mechanical Outline

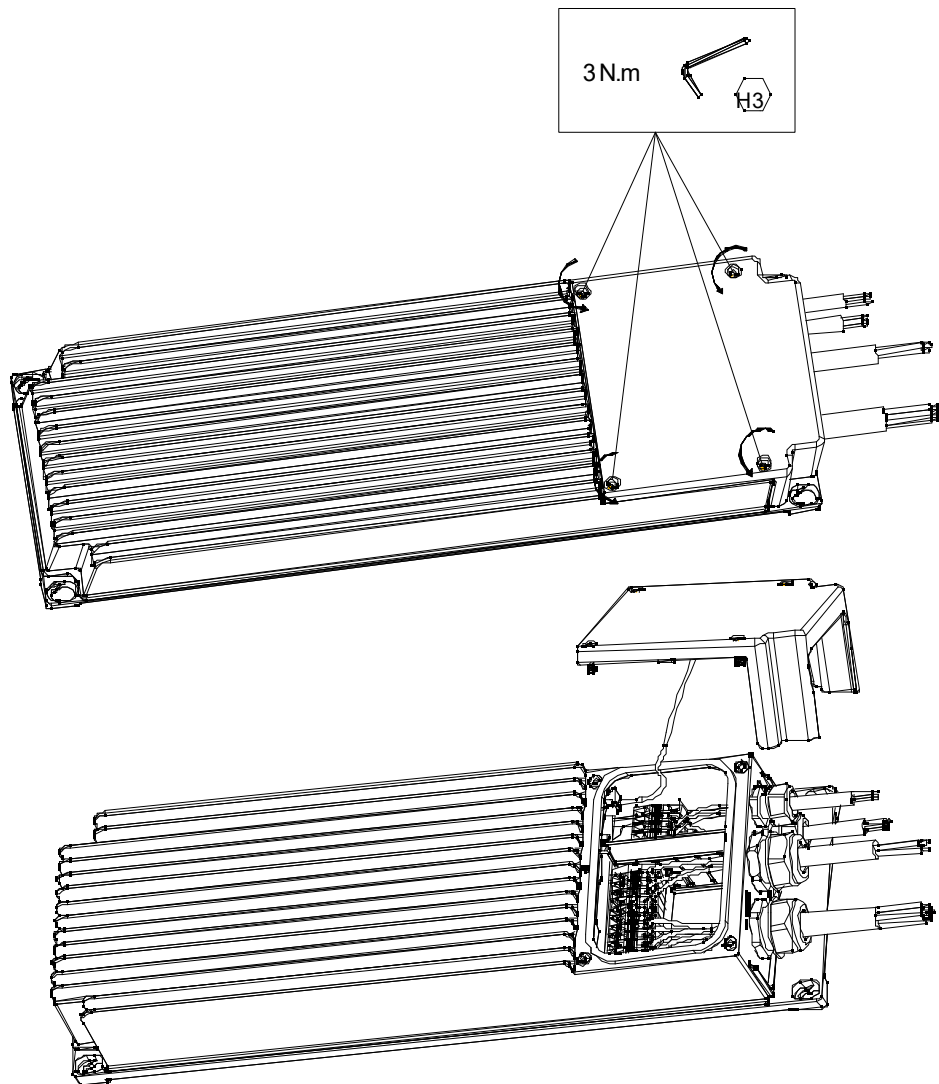
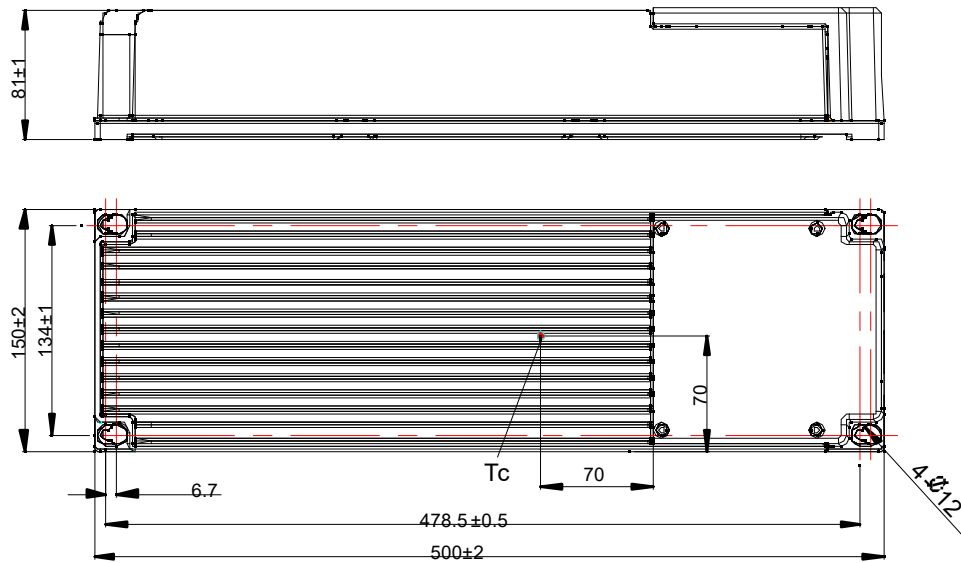

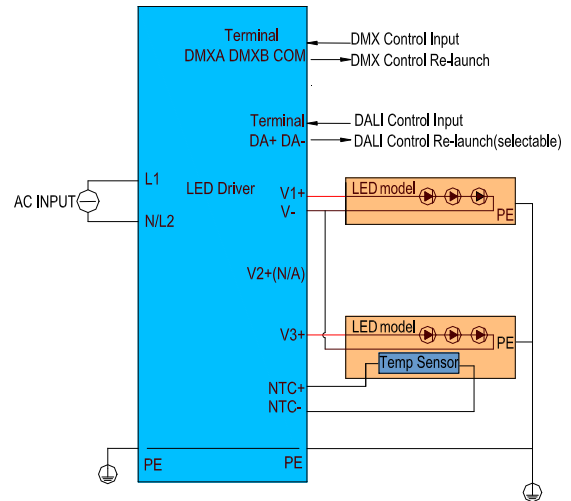
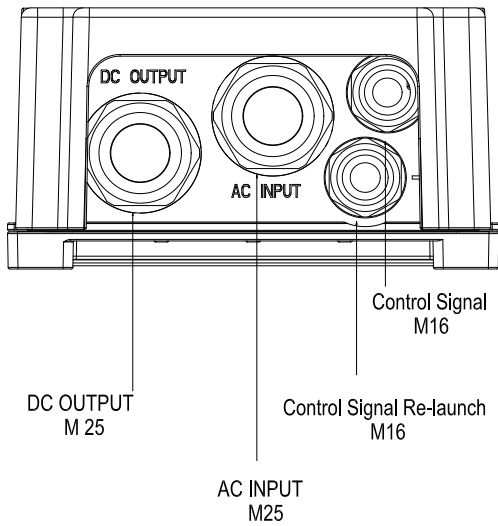

Wire Ports

V1+, V3+ cannot be connected together

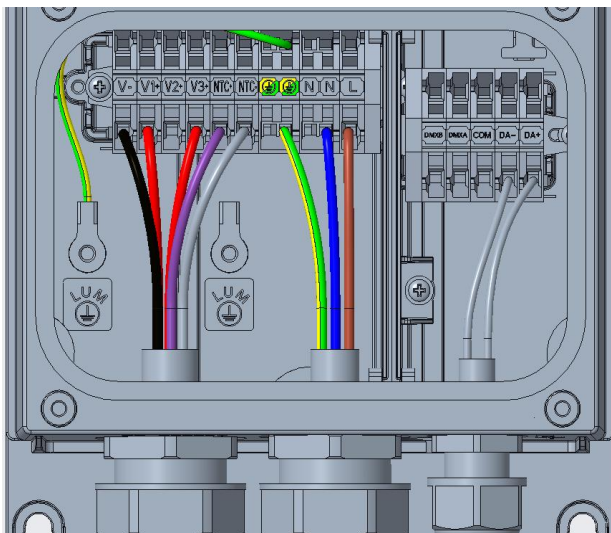

DALI Wiring Connection

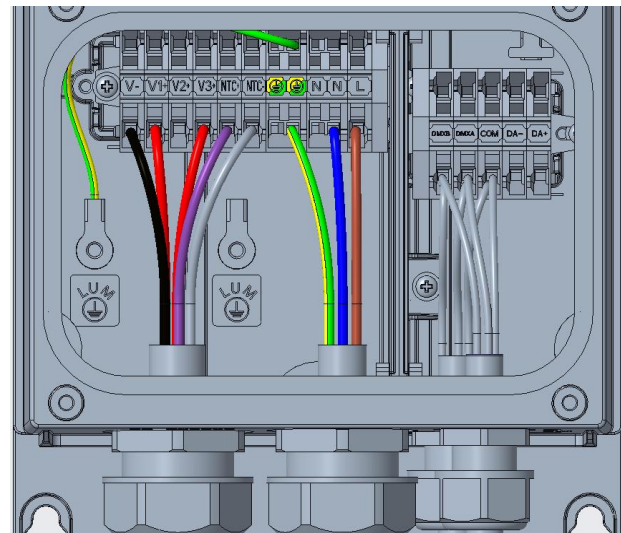

DMX Wiring Connection

Connections

Wire	Recommended wire Specification	Note
Input	M25 wire diameter range 9-16mm, optional for 13-18 mm ; Wire Cross-section: 1.0 mm ² - 4.0 mm ² / 16AWG-12AWG	
Output, NTC	M25 wire diameter range 9-16mm, optional for 13-18 mm ; Wire Cross-section: 1.0 mm ² - 4.0 mm ² / 16AWG-12AWG	
Dimming (DALI / DMX)	M16 wire diameter range 4-8mm, optional for 2-6mm Wire Cross-section: 0.5 mm ² - 1.5 mm ² / 22AWG-16AWG	
Dimming (DALI / DMX Re-launch)	M16 wire diameter range 4-8mm, optional for 2-6mm Wire Cross-section: 0.5 mm ² - 1.5 mm ² / 22AWG-16AWG	

Terminal	Recommended Connection Specification	Note
Input	M25, the torsion 5~6N.m	
Output, NTC	M25, the torsion 5~6N.m	
Dimming (DALI / DMX)	M16, the torsion 1~2N.m	
Dimming (DALI / DMX Re-launch)	M16, the torsion 1~2N.m	

Label (DALI CCC+CE+UL)

MOSO[®] S6-1K2D500
LED DRIVER(LED控制装置)
Constant current type(恒流模式)
Integrated SPD(内置防雷管)

INPUT 输入	220-400V~ 50/60Hz, 6A Max. PF: 0.9C-0.98, 1300W
OUTPUT 输出	Two channels output Single channel: 260-500V \rightleftharpoons 0.18-1.80A, 600W Max. Uout(最大电压)= 600V \rightleftharpoons Total Max. Power(最大功率): 1200W
t _c : 90℃	t _a : 50℃

CLASS P: "FOR CONNECTIONS USE WIRE RATED FOR AT LEAST 90°C (194° F) " OR EQUIVALENT
POUR LES CONNEXIONS UTILISER DES CONDUCTEURS D ALIMENTATION CONVENANT 90 °C
USE ONLY WITHIN AN ENCLOSURE; DOIT ÊTRE INSTALLÉ DANS UNE ENCEINTE
For use in permanently connected (fixed) equipment only

深圳茂硕电子科技有限公司
SHENZHEN MOSO ELECTRONICS TECHNOLOGY CO., LTD
No.1061, Songbai Road, Xili Town, Nanshan District,
Shenzhen, CHINA

MADE IN CHINA Suitable for Dry
For LED module only Damp and wet locations

Output
Input
Dimming

Label (DMX CCC+CE+UL)

MOSO[®] S6-1K2R500
LED DRIVER(LED控制装置)
Constant current type(恒流模式)
Integrated SPD(内置防雷管)

INPUT 输入	220-400V~ 50/60Hz, 6A Max. PF: 0.9C-0.98, 1300W
OUTPUT 输出	Two channels output Single channel: 260-500V \rightleftharpoons 0.18-1.80A, 600W Max. Uout(最大电压)= 600V \rightleftharpoons Total Max. Power(最大功率): 1200W
t _c : 90℃	t _a : 50℃

CLASS P: "FOR CONNECTIONS USE WIRE RATED FOR AT LEAST 90°C (194° F) " OR EQUIVALENT
POUR LES CONNEXIONS UTILISER DES CONDUCTEURS D ALIMENTATION CONVENANT 90 °C
USE ONLY WITHIN AN ENCLOSURE; DOIT ÊTRE INSTALLÉ DANS UNE ENCEINTE
For use in permanently connected (fixed) equipment only







深圳茂硕电子科技有限公司
SHENZHEN MOSO ELECTRONICS TECHNOLOGY CO., LTD
No.1061, Songbai Road, Xili Town, Nanshan District,
Shenzhen, CHINA

MADE IN CHINA Suitable for Dry
For LED module only Damp and wet locations

Output
Input
Dimming

Note:
The accessory package includes label of S6-1K2D500*1; Allen key(H3)*1; O-ring(13~18mm)*2; O-ring(2~6mm)*2

Label (DALI CE+BIS)

MOSO [®] S6-1K2D500 LED DRIVER Constant current type		IS15885(Part2/Sec13)
INPUT	220-400V~ 50/60Hz, 6.0A Max. PF:0.9C-0.98, 1300W	  R-41077186 www.bis.gov.in
OUTPUT	Two channels output Single channel: 260-500V== 0.18-1.80A, 600W Max. Uout= 600V== Total Max.Power: 1200W	
t _c :90°C	t _a :50°C	IP66    







SHENZHEN MOSO ELECTRONICS TECHNOLOGY CO., LTD
No.1061, Songbai Road, Xili Town, Nanshan District,
Shenzhen, CHINA

MADE IN CHINA For LED module only
Suitable for Dry
Damp and wet locations

 Output
Input
Dimming



Label (DMX CE+BIS)

MOSO [®] S6-1K2R500 LED DRIVER Constant current type		IS15885(Part2/Sec13)
INPUT	220-400V~ 50/60Hz, 6.0A Max. PF:0.9C-0.98, 1300W	  R-41077186 www.bis.gov.in
OUTPUT	Two channels output Single channel: 260-500V== 0.18-1.80A, 600W Max. Uout= 600V== Total Max.Power: 1200W	
t _c :90°C	t _a :50°C	IP66    

SHENZHEN MOSO ELECTRONICS TECHNOLOGY CO., LTD
No.1061, Songbai Road, Xili Town, Nanshan District,
Shenzhen, CHINA

MADE IN CHINA For LED module only
Suitable for Dry
Damp and wet locations

Output
Input
Dimming

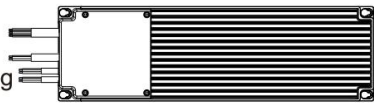

Cautions Label

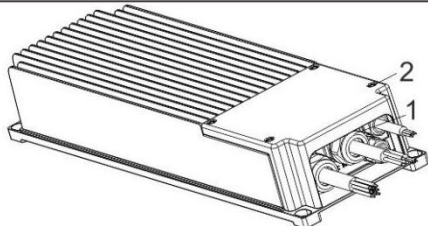

CAUTIONS

1. After the wiring is connected according to the datasheet, ensure that the gland is effectively locked to prevent water from damaging the driver.
2. When closing the electrical cover after wiring, ensure that the four fixing screws effectively tightened to prevent water from damaging the driver.

Shipping Barcode Label Standard

2	2	1	2	1	2	1	0	5	7	0	1	A	1	0	0	0	1	
Year		month		day		Part of production order number				Engineering level		REVISION RR		Production line number		Progressive Serial number		

Version

A.1	First release	2023-08-01
B.4	ERL202308034	2023-09-15

Specification for Approval

Product Name: 1200W Non-isolate LED Driver

Product Model: S6-1K2R500

Rev : B.4

Address: XiLi Songbai Road 1061, Nanshan District, Shenzhen City, Guangdong, China

Tel: 0755-27657000

FAX: 755-27657908

E-mail: info@mosopower.com

Web Site: <http://www.mosopower.com>

Prepared By	Checked By	Approved By

Specification for Approval

Product Name: 1200W Non-isolate LED Driver

Product Model: S6-1K2R500

Rev : B.4

CUSTOMER AUTHORIZED SIGNATURE		
Tested By	Checked By	Approved By
(Company seal)Return one copy to MOSO with approved signature and company seal.		

Address: XiLi Songbai Road 1061, Nanshan District, Shenzhen City, Guangdong, China

Tel: 0755-27657000

FAX: 755-27657908

E-mail: info@mosopower.com

Web Site: <http://www.mosopower.com>

Prepared By	Checked By	Approved By