



# SPECIFICATION

Customer: \_\_\_\_\_

Item: \_\_\_\_\_ Crystal Unit

Type: \_\_\_\_\_ NX5032GA

Nominal Frequency: \_\_\_\_\_ 25.000 MHz

Customer's Spec. No.: \_\_\_\_\_

NDK Spec. No.: \_\_\_\_\_

Receipt
---------

Charge:

Sales	NDK Italy Srl Alessia Meroni	Tel. (39)-02-96702920	Approved	K.Ueki
Engineer	1 <sup>st</sup> Engineering Dept. K.Nakashima	Tel. (81)-4-2900-6631	Checked	---
			Drawn	K.Nakashima

Revision Record				
Rev.	Rev. Date	Items	Contents	Remarks
----				

- 1.Customer specifications number :  
 2.NDK specification number : CG02135  
 3.Type : NX5032GA
- 4.Electrical characteristics
- 4.1 Nominal frequency : 25.000 MHz
  - 4.2 Overtone order : Fundamental
  - 4.3 Frequency tolerance :  $\pm 15 \times 10^{-6}$  max. (+25 °C)
  - 4.4 Frequency versus temperature characteristics :  $\pm 15 \times 10^{-6}$  max. (-10~+70 °C)  
 The reference temperature shall be 25°C
  - 4.5 Frequency aging :  $\pm 15 \times 10^{-6}$  max. / 10years (+25 °C)
  - 4.6 Equivalent resistance : 15Ω max. (+25 °C)  
 25Ω max. (-10~+70 °C)
  - 4.7 Shunt capacitance (C<sub>0</sub>) : 3.0F max..
  - 4.7 Maximum level of drive : 350μW max.
  - 4.8 Insulation resistance : Terminal to terminal insulation resistance also terminal to cover insulation resistance must be 500MΩ (min) when DC100V ±15V is applied.
  - 4.9 Pulling sensitivity (Reference only) :  $6.9 \times 10^{-6}$  /pF typ. (Where CL=19pF)
5. Measurement circuit
- 5.1 Frequency measurement
    - \*Measuring instrument : π-Network
    - \* Load capacitance(C<sub>L</sub>) : 12pF
    - \*Level of drive : 50μW
  - 5.2 Equivalent resistance measurement
    - \* Measuring instrument : π-Network
    - \* Load capacitance(C<sub>L</sub>) : Series
    - \*Level of drive : 50μW
6. Other performances
- 6.1 Storage temperature range : -40~+85°C
  - 6.2 Air-tightness : Less than  $3 \times 10^{-9}$  Pa m<sup>3</sup>/s (Helium leak detector)
7. Examination results document  
 Since a performance is guaranteed, an examination results document does not submit.
8. Application drawing
- 8.1 External dimension : EXD14B-00016
  - 8.2 Taping and reel figure : EXK17B-00027
  - 8.3 Holder marking : EXH11B-00027
  - 8.4 Reliability assurance Item : EXS30B-00020
  - 8.5 Recommendation reflow profile : EXS30B-00344

9. Notice

- 9.1 Order items are manufactured according to specification. As to conditions, which are not indicated in this specification and unpredictable such as applied condition and oscillation margin, please check them beforehand.
- 9.2 Unless we receive request for modification within 3 weeks from the issue date of this NDK specification sheet, we will supply products according to this specification. Also, if you'd like to modify specification of order, which has been placed with delivery request within 3 weeks from the issue data of this specification sheet, we would like to discuss with you separately.
- 9.3 In no event shall the company be liable for any product failure resulting from an inappropriate handling or operation of the product beyond the scope of its guarantee.
- 9.4 Where any change to the process condition is made due to the change(s) in the production line, inform personnel of the specifications.
- 9.5 Should this specification data give rise to any disputes relating to any intellectual property rights or any other rights of a third person, the company shall not indemnify anyone for any damage. Their disclosure must not be construed as the grant of a license to use any of the intellectual property rights owned by the company.
- 9.6 If you intend to use products listed on this specification for applications that may result in loss of life or assets (controls relating to safety, medical equipment, aeronautical equipment, space equipment, etc.), please do not fail to advise us of your intention beforehand.
- 9.7 In the company's production process whatever amount of ozone depleting substances (ODS) as specified in the Montreal protocol is not used.
- 9.8 Information contained in this specification must not be quoted, reproduced or used for other purposes including processing either in part or in full without obtaining prior approval from the company.

10. Prohibited items

Be sure to use the product under the following conditions. Otherwise, the characteristics deterioration or destruction of the product may result.

(1)Reflow soldering heat resistance

Peak temperature: 265°C, 10 sec

Heating: 230°C or higher, 40 sec

Preheating: 150°C to 180°C, 120 sec

Reflow passage times: twice

(2)Manual soldering heat resistance

Pressing a soldering iron of 400°C on the terminal electrode for four seconds (twice).

When using a soldering iron, press its tip on the part below the sealed part, avoiding the glass-sealed part (otherwise, the glass will melt and air-tightness may be lost).

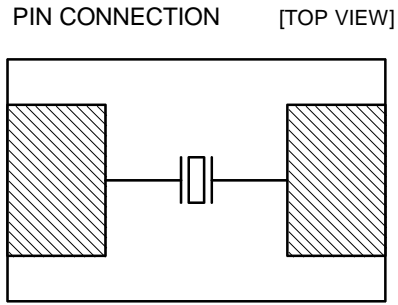
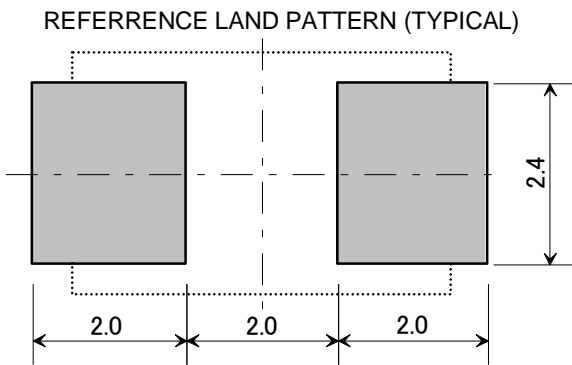
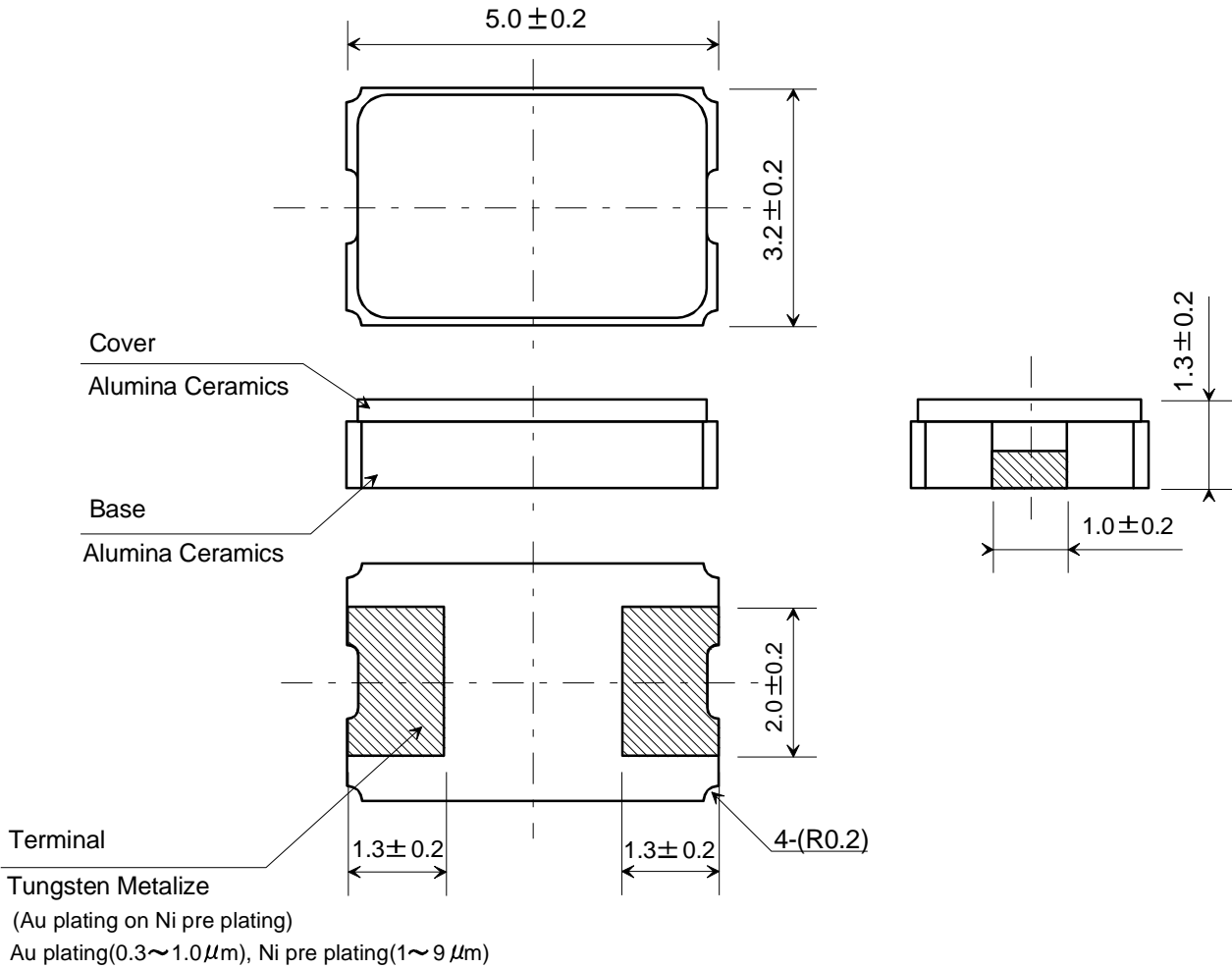

	Date of Revise	Charge	Approved	Reason	
E	15.Sep.2006	N.Yamamoto	K.Kubota	Change reference land pattern size	
	Date	Name	Third Angle Projection	Tolerance	
Drawn	19.Mar.1999	Y.Morizumi	Dimension:mm	Scale	
Designed	19.Mar.1999	Y.Morizumi	Title <b>NX5032GA External Dimension</b>	Drawing No. <b>EXD14B-00016</b>	
Checked	19.Mar.1999	M.Miura			Rev.
Approved	19.Mar.1999	M.Okamoto			E

**NIHON DEMPA KOGYO CO., LTD.**

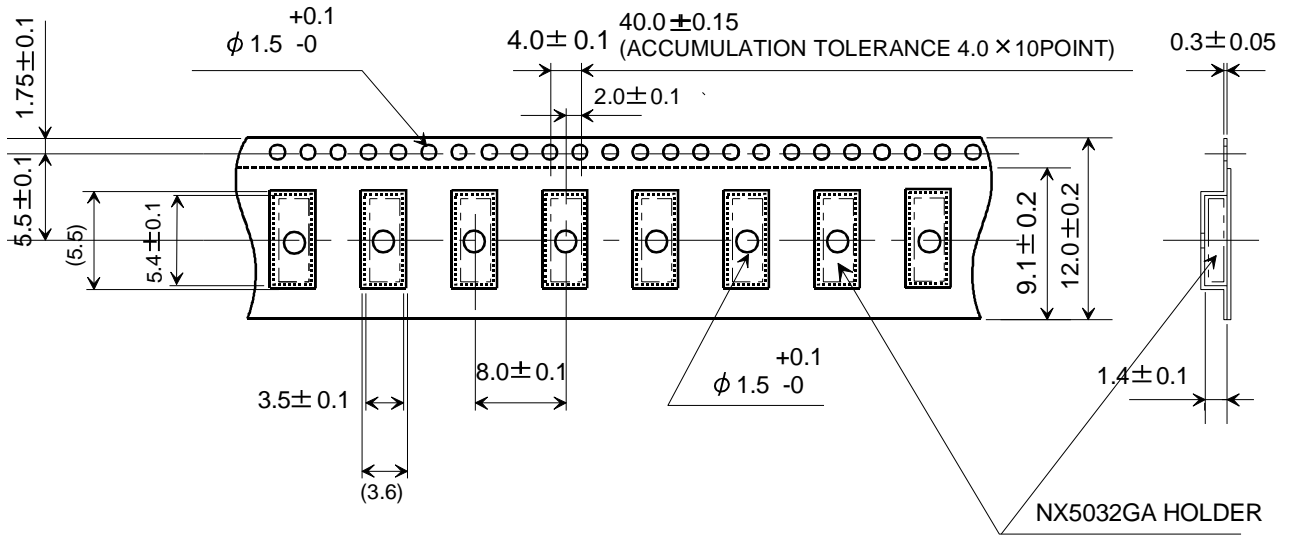

TAPING

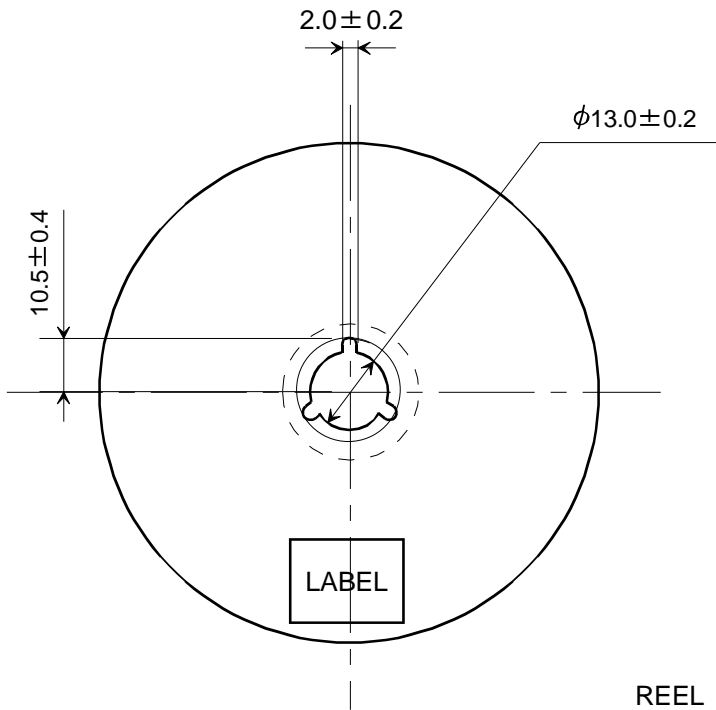

REEL

QTY.
1000 PCS

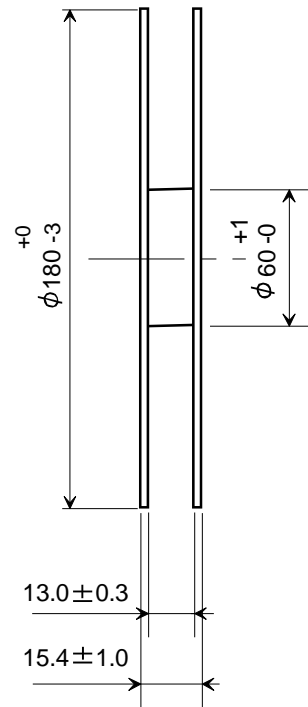

	Date of Revise	Charge	Approved	Reason
B	9.Jul.2003	Y.Sakurai	T.Ishii	Size addition
	Date	Name	Third Angle Projection	Tolerance
Drawn	13.Jul.1999	Y.Morizumi	Dimension:mm	Scale
Designed	13.Jul.1999	Y.Morizumi	Title	Drawing No.
Checked	-----	-----	<b>Crystal Holder Packing</b>	<b>EXK17B-00027</b>
Approved	13.Jul.1999	M.Okamoto		
				<b>B</b>

**NIHON DEMPA KOGYO CO., LTD.**



Month Code (SEE NOTE

Year Code (Last One Digit)

Manufacture's Symbol

Frequency Code (SEE NOTE

NOTE

1. Frequency Code

Marking Frequency Code is consist of five digit five digits

Example

Nominal Frequency 28.636363 MHz

Frequency Code 28.636

	Date of Revise	Charge	Approved	Reason	
B	9.Nov.2000	H.Yagishita	T.Ishii	Change Form	
	Date	Name	Third Angle Projection	Tolerance	Scale
Drawn	3.Aug.1999	Y.Morizumi	Dimension:mm		/
Designed	3.Aug.1999	Y.Morizumi	Title	Drawing No.	Rev.
Checked	-----	-----			<b>Crystal Holder Marking</b>
Approved	3.Aug.1999	T.Ishii			

**NIHON DEMPA KOGYO CO., LTD.**

**Reliability assurance item**

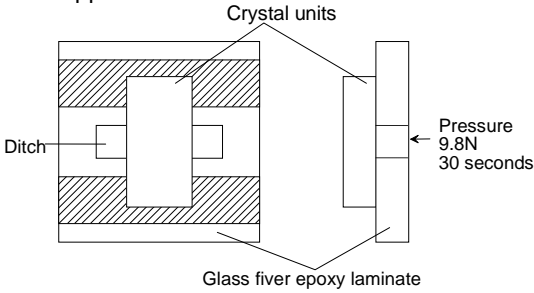
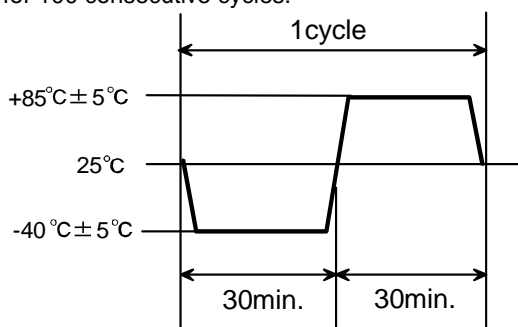
No.	Test Item	Test Methods	Specification Code
1	Drop	Devices are dropped from the height 75cm onto wooden block. ( more than 30mm thickness. ) Execution 3 times random drops.	A
2	Shock	Devices are shocked to half sine wave ( $981\text{m/s}^2$ ) three mutually perpendicular axis each 3 times.	A
3	Vibration	Frequency Range : 10 to 55 Hz Amplitude : 1.5mm Sweep time : 1 min. Test time : 2.0 hours	A
4	Electrode adherent strength	Reflow soldering shall be used for soldering on test fixture (Glass fiber epoxy laminate : Thickness 1.6mm+/-0.2mm) shown below. (220~240°C) Be careful to happen the heat shock. 	B
5	Solderability	Pre-heat temperature : 150°C Pre-heat Time : 60~120sec. Peek temperature : 240±5°C Soldering temperature : Over 215°C Test time : 10~30 sec.	C
6	Resistance to soldering heat	Pre-heat temperature : 150 °C Pre-heat time : 60 ~ 120sec. Test temperature : 260 ± 5 °C Test time : 10 sec. Max.	A, B
7	Resistance to cold	Leave at $-40^{\circ}\text{C} \pm 2^{\circ}\text{C}$ for 500 hours.	A
8	Resistance to heat	Leave at $+85^{\circ}\text{C} \pm 2^{\circ}\text{C}$ for 500 hours.	A
9	Humidity	Devices are left in temperature at $+60^{\circ}\text{C}$ with relative humidity of 90~95% for 500 hours.	A, D
10	Thermal shock	Devices are left into the following temperature cycle as shown in (Figure 1) for 100 consecutive cycles. 	A, B

Specification code	Specification
A	Frequency tolerance and series resistance should be cleared.
B	After testing unless cracking of materials view of eyes and unless break of seal.
C	The leads shall acquire a new solder coat cover at 90% of immersed area.
D	Insulation resistance shall be greater than 500MΩ

### Recommendation reflow condition

#### 1.IR reflow condition

