

Recommended P.C.B. Layout

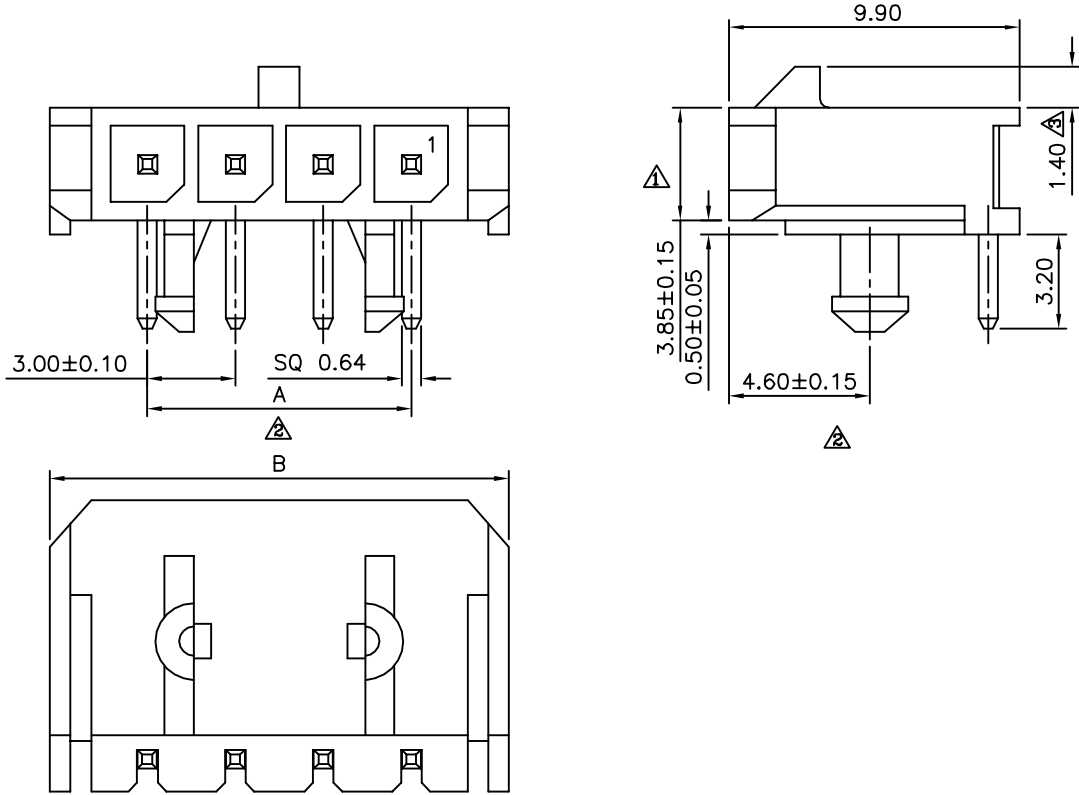

**△ SPECIFICATION**  
**1.General Characteristics**  
 3.0mm Micro Fit 1XXX DIP 90° Male With Post  
**2.Material&Finish**  
 Insulator:PBT+30%G.F.(UL94V-0),Black  
 Contact:Brass,Tin Plated  
**3.Electrical Characteristics**  
 Current Rating:5A AC/DC  
 Voltage Rating:250V AC/DC  
 Withstand Voltage:1500V AC For 1 Minute  
 Contact Resistance:10 Milliohms Max.  
 Insulation Resistance:1000 Megaohms Min.  
**4.Environmental Characteristics**  
 Operation Temperature Range:-25°C~+85°C  
**5.RoHS Compliant**

△ MIF 1 X XX P RP - H  
 (1) (2) (3) (4) (5) (6)

- (1) MIF:3.0mm Micro Fit
- (2) 1:Single Row
- (3) XX:No. Of Position/Per Row
- (4) P:Male
- (5) RP:DIP Right Angle With Post
- (6) H:RoHS Compliant

Pin	A	B	C
1	-	6.65	-
2	3.00	9.65	-
3	6.00	12.65	-
4	9.00	15.65	4.70
5	12.00	18.65	7.70
6	15.00	21.65	10.70
7	18.00	24.65	13.70
8	21.00	27.65	16.70
9	24.00	30.65	19.70
10	27.00	33.65	22.70
11	30.00	36.65	25.70
12	33.00	39.65	28.70

**AUK** A MEMBER OF AUK GROUP  
**太聯事業股份有限公司**  
**AUK CONTRACTORS CO., LTD.**

CATEGORY		APPROVED BY		UNLESS OTHERWISE SPECIFIED TOLERANCES ARE .X ±0.50 .XX ±0.25 .XXX ±0.10 ANG. ±2°
PART No. MIF1XXXPRP-H		EMILY		
DRAWING No. MIF1XXXPRP-H		CHECKED BY HZF		
SCALE NONE		DRAWING BY SONG		
REV.	A3	UNIT mm		

NO.	REV.	REVISIONS	CHK	DATE
△ A3		Add Dim. 1.40	HZF	07/08/2011
△ A2		Modify Data	HZF	06/21/2011
△ A1		Modify Data	HZF	08/02/2008
△ A0		NEW RELEASE	HZF	11/14/2007

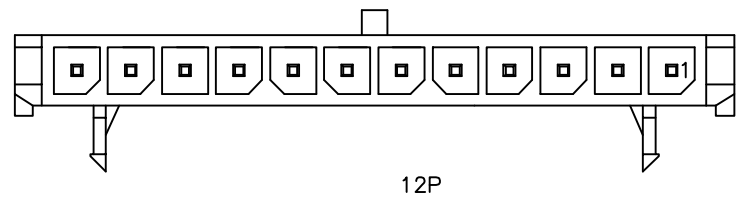
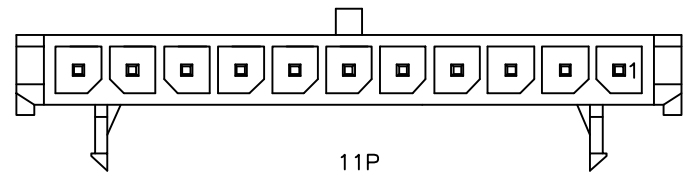
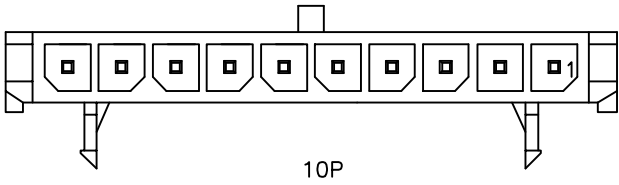
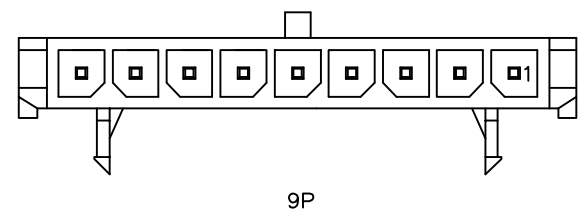
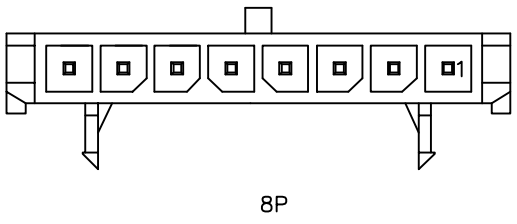
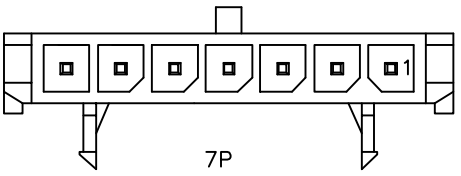
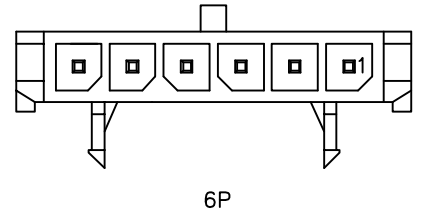
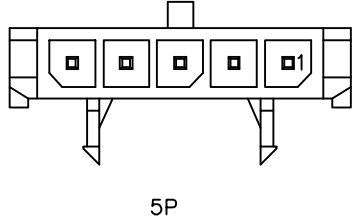
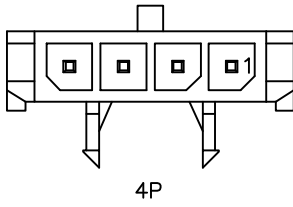
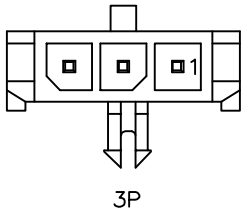
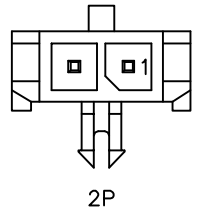

**AUK** A MEMBER OF AUK GROUP  
**太聯事業股份有限公司**  
**AUK CONTRACTORS CO., LTD.**

CATEGORY		APPROVED BY	
PART No. MIF1XXXPRP-H		EMILY	
DRAWING No. MIF1XXXPRP-H		CHECKED BY HZF	
SCALE		DRAWING BY SONG	
NONE	REV.	A3	

UNLESS OTHERWISE SPECIFIED TOLERANCES ARE  
.X ±0.50  
.XX ±0.25  
.XXX ±0.10  
ANG. ±2'  
UNIT mm

NO.	REV.	REVISIONS	CHK	DATE
△A3		Add Dim. 1.40	HZF	07/08/2011
△A2		Modify Data	HZF	06/21/2011
△A1		Modify Data	HZF	08/02/2008
△A0		NEW RELEASE	HZF	11/14/2007