

A

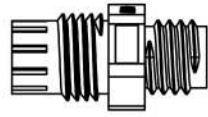

B



C



D



E

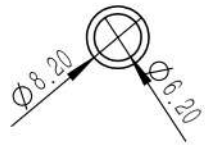
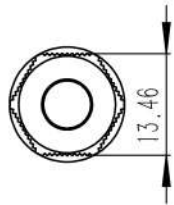
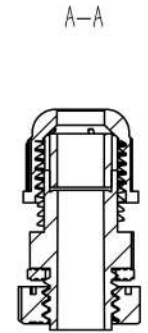
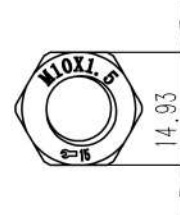
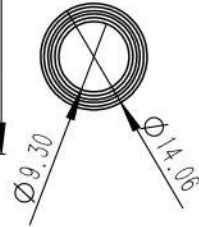
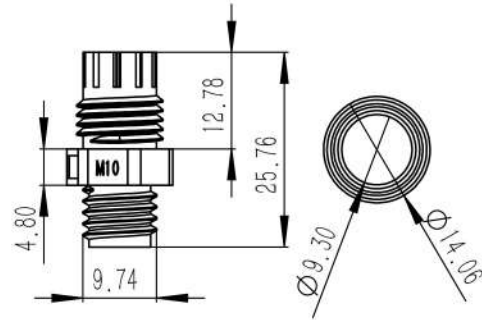
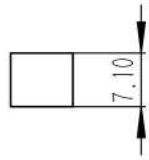
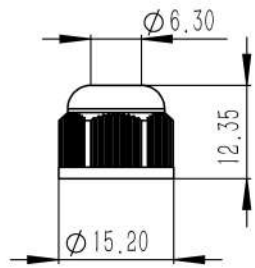

B

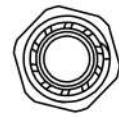

C

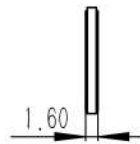

D

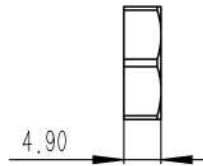

E

Technical

PA66

IP65

Range:3-6.5mm

-40-100°

Tolerance

0-10 ±0.2

10-20 ±0.3

20-30 ±0.4



Xiamen Fucon Electronics Co.,LTD

M10x1.5-N-G