



With side covers

Constant Voltage Driver

Model: LV150W24 G2
LV150W48



Model	Output Current	Input Current	Input Power	Output Power Range	PF	Efficiency (*Typical)	Output Voltage	No load Voltage
LV150W24 G2	0-6200mA	0.55A	≤164W	0-150W	≥0.95	92%	24V	24V
LV150W48	0-3100mA	0.55A	≤162W	0-150W	≥0.95	93%	48V	48V

* Test result @230V, 50Hz, Full Load.

* Recommended minimum full load power is 10% load.

1. Parameters

Category	Item	Technical Norm
Features	Output Type	Constant Voltage
	Output Features	Isolation
	IP Grade	IP20
	Insulation Class	Class II
Input	Rated Input Voltage	220-240VAC
	Range of Input Voltage	198-264VAC or 180-280VDC
	Frequency	0/50/60Hz
	Input Current	≤0.85A (230VAC, full load)
	Input Power	≤164W (230VAC, full load)
	Power Factor	≥0.95 (230VAC, full load)
	THD	≤15% (230VAC, full load)
	No-load Power Consumption	≤0.5W @230VAC
	Inrush Current	≤45A/16us (230VAC, full load)
Output	Output Voltage Range	24VDC ± 5% or 48VDC ± 5% (Potentiometer adjusts output voltage ± 2V)
	No Load Voltage	24VDC ± 5% or 48VDC ± 5%(Potentiometer adjusts output voltage ± 2V)
	Output Current	0-6200mA or 0-3100mA(Max. output)
	Max. Output Power	150W
	Efficiency	≥92% (230VAC, full load)
	Current Ripple(< 120 Hz)	±5% (Imax-Imin)/(Imax+Imin)
	Output Voltage Ripple	<240mV _{PK-PK} (0.5%) or <480mV _{PK-PK} (0.5%)

	Line Regulation	±5%
	Load Regulation	±5%
	PstLM	≤1
	SVM	≤0.4
	Overshoot	<105%Vo
	Current Accuracy	±5%
	Started Delay Time	≤0.5S(230VAC, full load)
Protection	Short Circuit Protection	Auto Recovery
	Overload Protection	Auto Recovery
	Over Voltage Protection	110%-150%Vo, Auto Recovery
	Over Temperature Protection	90<Tc<110°C, Auto Recovery
	No-load Protection	Auto Recovery
	Insulation voltage	3000V 5mA 60S between P-S
	Insulation resistance	>100M ohm @ 500VDC
	Leakage current	I/P to O/P <0.7mA
Environment	Ta/Operation Temperature	-20....+50°C
	Ts/Storage Temperature	-25....+85°C
	Tc/Enclosure Temperature	85°C
	Humidity	10%....90%RH
	Atmosphere	86-108KPa
Construction	Connection Method	Push-in Terminal
	Installation	Built-in&Independent (Can be either used built-in or independent with side covers)
	PRI Wire preparation	0.75-2.5 ^² / 8-9mm
	SEC Wire preparation	0.75-2.5 ^² / 8-9mm
	Dimension	360*30*21mm (L*W*H)
Standards	Certification	CE ENEC SAA
	Safety Standards	EN 61347-1:2015/A1:2021 EN 61347-2-13:2014/A1:2017 EN IEC 62384:2020 EN 62493:2015 AS61347.2.13:2018 AS/NZS61347.1:2016 Inc A1 BS EN 61347-1:2015/A1:2021 BS EN 61347-2-13:2014/A1:2017 BS EN 62493:2015 BS EN IEC 62384:2020
	EMC Standards	EN IEC 55015:2019 EN IEC 55015:2019/A11:2020 EN IEC 61000-3-2:2019/A1:2021 EN 61000-3-3:2013/A2:2021 EN 61547:2009
	Performance	EN62384:2020
	Surge	L-N/1KV (L/N)-PE/2KV
Others	RoHS	complied to 2011/65/EU

	REACH	EU Regulation (EC) No 1907/2006
	Life Time	50000h @Ta=50°C
	Warranty	5years ,F.R. < 10000ppm
	Noise	≤ 24dB @Background noise ≤18dB ,Interval≥15cm

Remark:









1. All Parameters, if not specified, are measured at 230VAC/50Hz and 25°C ambient temperature.
2. LED Driver is a component of the luminaires, Luminaires and wire layout will affect the EMC, please check the EMC with end products again.
3. Do not install upside down.









2. Connected quantities of different current Breaker

TYPE	Connected quantities of different current Breaker						Input Voltage (V)	Inrush Current(A)	Time (µs)
	current (A)	10	13	16	20	25			
	Installation wire diameter	1.5mm ²	2.5mm ²	2.5mm ²	4mm ²	4mm ²			
TYPE B	13	17	21	27	33	@230VAC	45	16	
TYPE C	21	28	34	43	53				
TYPE D	34	44	55	68	85				









3. Label









LV150W24 G2

<input type="checkbox"/> L <input type="checkbox"/> N PRI <input type="checkbox"/> ⊕	 KGP Electronics GmbH Hueckstraße 19 DE-58511 Lüdenscheid	LED Driver LV150W24 G2 Constant Voltage Type for LED Only wire preparation 	Input Voltage:220-240V≈ Input Frequency:0/50/60Hz Power Factor(λ):≥0.95 I in:≤0.78A	U rated=24VDC I rated:6.25A Max. Prated:150W Max. tc:85°C ta:-25...50°C	etc       	SEC - <input type="checkbox"/> SEC + <input type="checkbox"/> Uo <input type="checkbox"/>
--	--	--	--	--	--	---

<input type="checkbox"/> L <input type="checkbox"/> N PRI <input type="checkbox"/> ⊕	 KGP Electronics GmbH Hueckstraße 19 DE-58511 Lüdenscheid	LED Driver LV150W24 G2 Constant Voltage Type for LED Only wire preparation 	Input Voltage:220-240V≈ Input Frequency:0/50/60Hz Power Factor(λ):≥0.95 I in:≤0.78A	U rated=24VDC I rated:6.25A Max. Prated:150W Max. tc:85°C ta:-25...50°C	etc       	SEC - <input type="checkbox"/> SEC + <input type="checkbox"/> Uo <input type="checkbox"/>
--	--	--	--	--	--	---

LV150W48

<input type="checkbox"/> L <input type="checkbox"/> N PRI <input type="checkbox"/> ⊕	 KGP Electronics GmbH Hueckstraße 19 DE-58511 Lüdenscheid	LED Driver LV150W48 Constant Voltage Type for LED Only wire preparation 	Input Voltage:220-240V≈ Input Frequency:0/50/60Hz Power Factor(λ):≥0.95 I in:≤0.85A	U rated=48VDC I rated:3.125A Max. Prated:150W Max. tc:85°C ta:-25...50°C	etc       	SEC - <input type="checkbox"/> SEC + <input type="checkbox"/> Uo <input type="checkbox"/>
--	--	---	--	---	--	---

<input type="checkbox"/> L <input type="checkbox"/> N PRI <input type="checkbox"/> ⊕	 KGP Electronics GmbH Hueckstraße 19 DE-58511 Lüdenscheid	LED Driver LV150W48 Constant Voltage Type for LED Only wire preparation 	Input Voltage:220-240V≈ Input Frequency:0/50/60Hz Power Factor(λ):≥0.95 I in:≤0.85A	U rated=48VDC I rated:3.125A Max. Prated:150W Max. tc:85°C ta:-25...50°C	etc       	SEC - <input type="checkbox"/> SEC + <input type="checkbox"/> Uo <input type="checkbox"/>
--	--	---	--	---	--	---

4. Electrical values

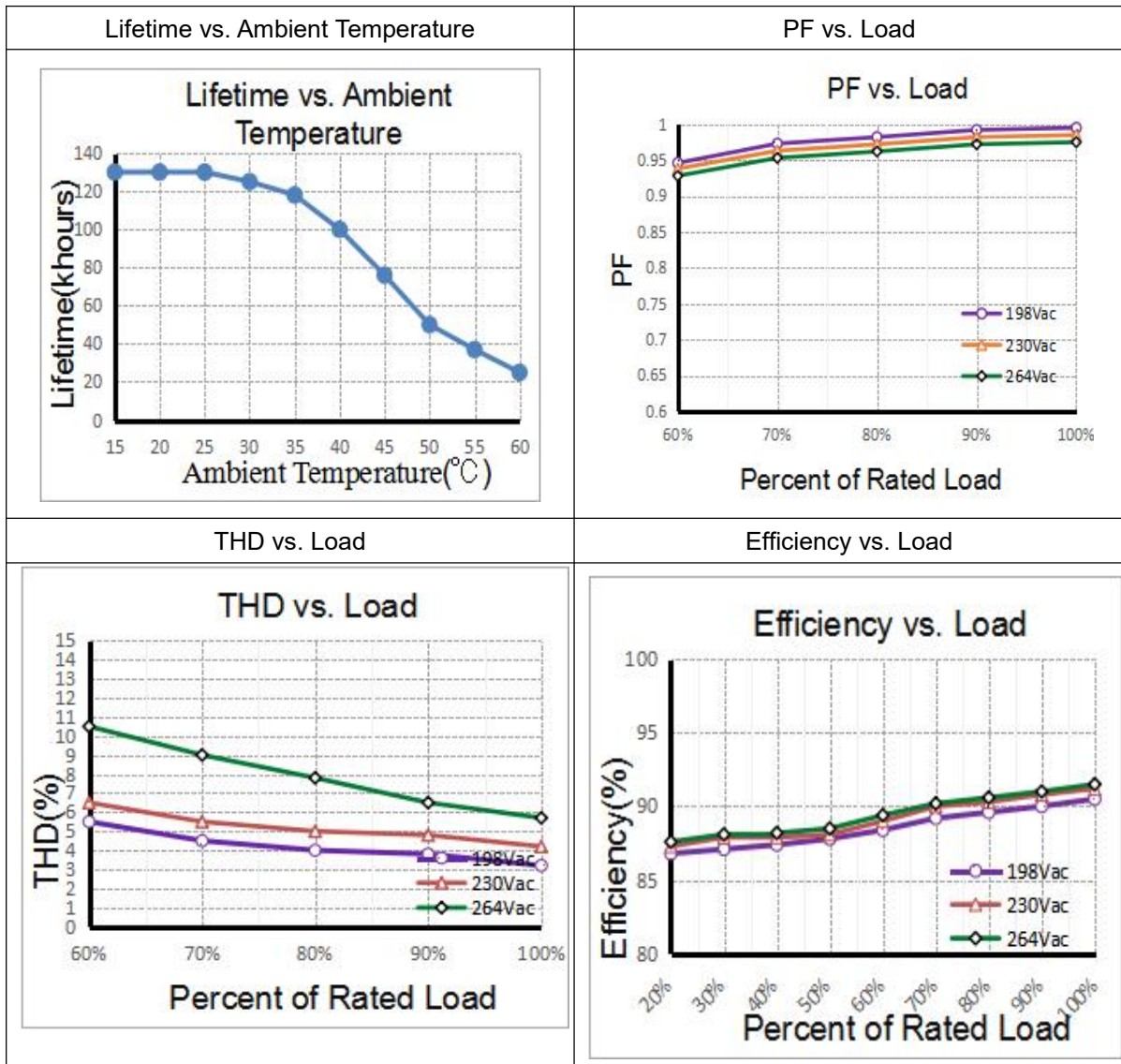

5. Dimension (Unit: mm)

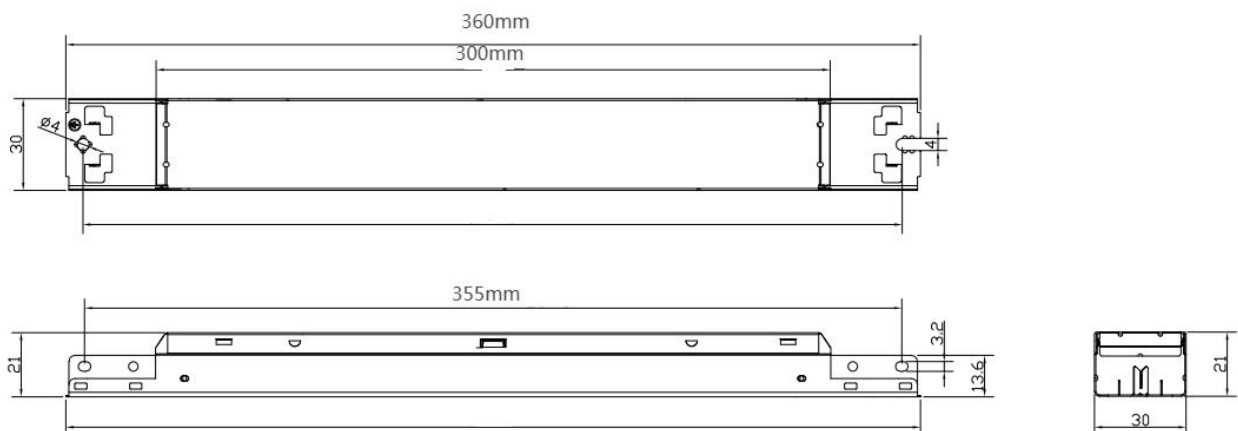

6. Wiring Diagram

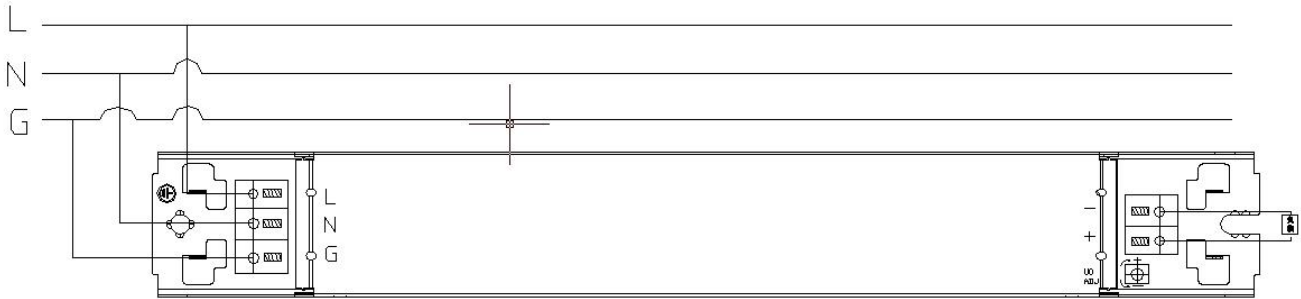

7. Packing information

Packing way	Model	Type	Carton L*W*H(mm)	Pcs/ Carton	Net weight/ Pcs(kg)	Net weight/ Carton(kg)	Gross weight/ Carton(kg)
Industrial	LV100W24 G2 LV100W48	Built-in	415*330*160	40	0.305	12.2	12.65
		Independent	380*250*155	45	0.289	13	13.45

8. Wiring instructions

- All connections must be kept as short as possible to ensure good EMI behaviour
- Mains leads should be kept apart from LED Driver and other leads (ideally 5 – 10 cm distance)
- Advice the maximum length of output wires is 0.5 m
- Secondary switching is not permitted (Except for constant voltage)
- Incorrect wiring can damage LED modules.
- The wiring must be protected against short circuits to earth (sharp edged metals parts, metal cable clips, louver, etc.)
- Hot plug-in is not supported due to residual output voltage of > 0 V up to mains voltage. Danger to life.
- When connecting an LED load, restart the device to activate the LED output.

9. Replace LED module

- Mains off
- Remove LED module
- Wait for 30 seconds
- Connect LED module again
- Hot plug-in or secondary switching of LEDs is not permitted and may cause a very high current to the LEDs

10. REVISION HISTORY

DATE	REV	Modification details
2025-01-14	V1.0	Initial release