

Customer:	ETCZ0	Customer P/N:	
-----------	-------	---------------	--

1.Mechanical Dimension:

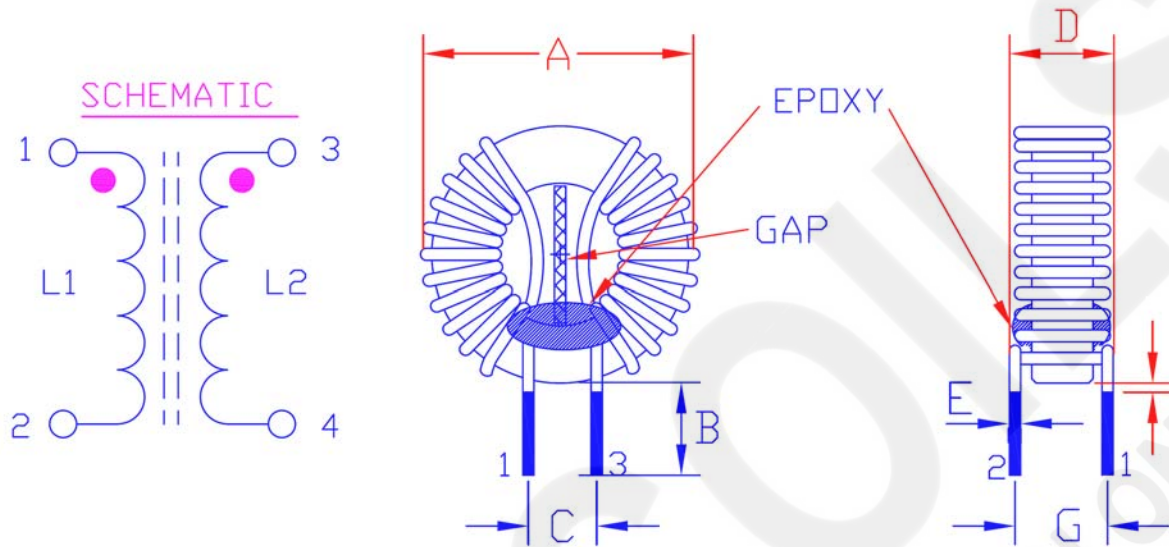

Item	Spec.(mm)	Typ.(mm)	Item	Spec.(mm)	Typ.(mm)
A	41.0 MAX	36.30	F	1.5 MAX	1.23
B	15.0 +- 2.0	15.03	G	15.0 REF	15.58
C	20 +- 1.5	20.55	H		
D	22.0 MAX	17.75	I		
E	1.6 +- 0.1	1.60	J		

Notes:

3L P/N :	LFT3113-601U-15A	Rev.	XA	Date:	2023/03/30
----------	------------------	------	----	-------	------------

Customer:	ETCZO	Customer P/N:	
-----------	-------	---------------	--

2. Electrical Characteristics (at 25degC / RH 65% unless otherwise specified):

Test Item	Specifications	Test conditions	Typ.	Test Instrument
L1;L2	600uH MIN	@1KHz 0.25V	876.3uH	Agilent4284A
DCR1;DCR2	7.0mΩ MAX		3.74mΩ	ChenHwa502
R.Current	15A MAX			Agilent4284A
Turns	10Ts:10Ts REF			
Hi-pot test	@AC 2KV 1mA 3Sec	Between COIL & COIL	PASS	Extech7142
Ope.Temp.	-20 TO 80°C			Testo608-H2
Weight	46.06g/pcs			

Notes :

3L P/N :	LFT3113-601U-15A	Rev.	XA	Date:	2023/03/30
----------	------------------	------	----	-------	------------

Customer:	ETCZ0	Customer P/N:	
-----------	-------	---------------	--

4. Packaging Specification:

Inside Packaging:

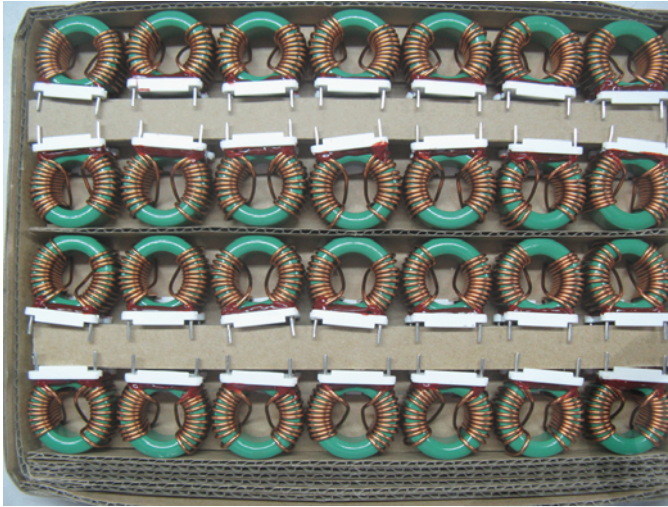

Notes of inside packing :

Each board: 28 pcs;

The packaging shown on specification might be done by method and requirement of similar product. But, there might be slight difference between packaging picture and real package.

Outside Packaging: 5-CT-261916.gif/5-CT-412718.gif

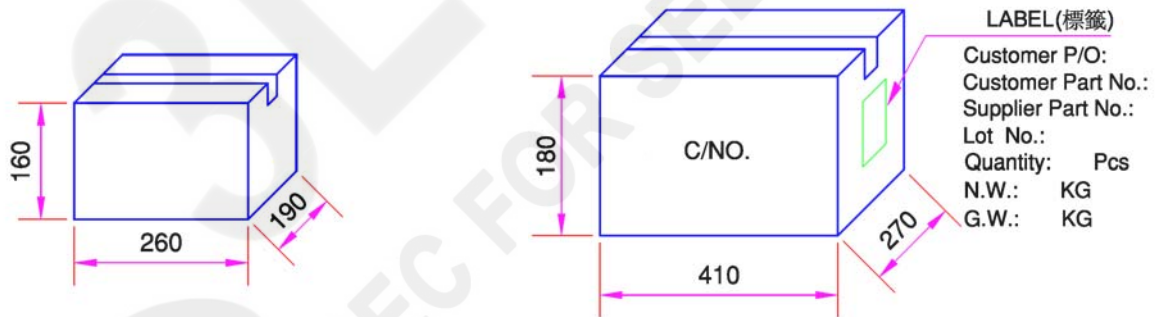

Small carton: 168 pcs; Outer carton: 336 pcs; NW.: KG; GW.: KG

Notes :

3L P/N :	LFT3113-601U-15A	Rev.	XA	Date:	2023/03/30
----------	------------------	------	----	-------	------------



Cautions and Warnings



Rev: 08 Page 1 of 4

Scope of 3L products:

1. 3L components are manufactured and promoted for applying in general electronics devices such as audio-video equipment, home electric appliance, office automation equipment, communication equipment, power module, LED lighting, measurement hardware, machine accessory, etc.
2. If 3L product will be applied in area like automotive product, medical equipment, military and aerospace except general electronic device, please keep 3L sales informed in advance. 3L shall not be held liable for any malfunction or breakdown caused by using product in the condition which is inconsistent with that recommended by 3L.
3. If there is problem occurring when using product or information on 3L's catalogue, which may affect industrial property or any other rights of 3L Group (or a third party), 3L Group shall not be held liable in such situation, nor grant any license to the offending party.
4. Some parts of this publication contain statements about the suitability of our products for certain areas of application. These statements are based on our knowledge of typical requirements that are often placed on our products in the areas of application concerned. We nevertheless expressly point out that such statements cannot be regarded as binding statements about the suitability of our products for a particular customer application.
5. Generally, 3L might not be familiar with either customer's specific application or actual requests as customer does. As a result, customer shall be responsible for checking and confirming whether 3L product with the performance described in the product specification is suitable for using in customer's particular application or not.
6. We also have to point out that in individual cases, any trouble or failure of electronic components happens during their long span cannot not be completely cleared even if someone operates according to instruction with existing technology.
7. Please pay attention to the storage conditions that temperature: below 35°C and humidity: 35-65% RH. If product is preserved for more than 1 year, the solderability of their terminals may be deteriorated.
8. 3L recommend reflow soldering for SMT product and wave soldering for DIP product while for specific DIP product, iron soldering might be preferred. Please confirm with 3L if other soldering method is applied to prevent issue such as short, open, fracture, deformation and etc., otherwise 3L will not take any responsibility for above issue.
9. The aforementioned items do not apply to individual agreements and the foregoing customer-specific products.

Please read cautions and warnings, important notes at the end of this document.

If you have any question, please contact 3L.

General instruction for parts usage:

1. Please pay more attention to the installation position of the non-magnetic shield type coil when you design the printed circuit board to prevent malfunction caused by magnetic interference.

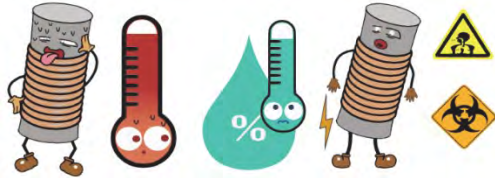

2. Product should not be exposed to environment with high temperature, high humidity, dust, corrosive gas and etc.

3. The soldering conditions should also be observed. Temperature mentioned refers to the temperature of wave soldering for PIN or terminals but not the temperature of product itself.

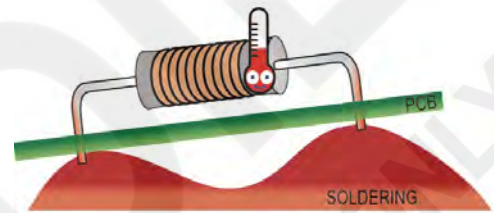

4. Please take the thermal design into consideration when choosing appropriate product, because the coil generates heat when electric current is applied.

5. Please don't use products in a place with dewing. Please be careful when products is applied in a sealed condition since dewing would happen due to temperature change.

6. Please always handle products carefully to prevent any damage caused by dropping down or inappropriate removing.



7. Don't touch electrodes directly with bare hands since oil secretions may do harm to solderability.

8. Don't bend the terminals with excessive stress in case of any wire fracture.



9. Please ensure that all terminals and case lugs are completely fixed onto PCB by soldering, and avoid placing coils near the edge of the PCB.

10. Don't rinse coils by yourself and please contact 3L if necessary.



Please read cautions and warnings, important notes at the end of this document.

If you have any question, please contact 3L.

11. Since our SMD coils are designed for automatic mounting, please be careful when soldering manually. Please don't touch any exposed winding part and coil should not be used guiding by electrode in automatic mounting.

12. Our specification specifies the quality of the component as a single unit. Please ensure the component is thoroughly evaluated in your application circuit.

13. When using our high voltage inverter transformers, please place it 2mm away from other electric conductors.

14. The following points must be paid attention to if the components are potted or glued to stick in customer applications:

- Many potting materials shrink as they harden. Therefore, they exert a pressure on the plastic housing or core, which may have a deleterious effect on electrical performance. In extreme cases, it would damage the mechanical performance of core or plastic housing.
- It is necessary to check whether the potting material used would lead to undesirable performance or break down of insulating layer of enameled wire, plastic bobbin or glue.
- The potting material can affect the high-frequency behavior of components.
- Ferrites are sensitive to direct shock, which might hurt or even break the core.
- For non-Alloy or non-coated molded inductors, its surface might become rusted if it was left in the humid environment. However, its electrical performance would not be affected.
- Even for customer-specific products, conclusive validation of the component in the circuit can only be carried out by customer.



Please read cautions and warnings, important notes at the end of this document.

If you have any question, please contact 3L.

Note 1. The general testing condition is Temperature: 25 +/- 5°C (Room temperature) and humidity: 35-65% RH, which is applied to all products except specific product.

Note 2. For DIP type products, when the pin length is more than 5mm, the test position should be at 2-5mm away from the bottom of the product; For SMT type products, it is suggested to ensure better contact between the products and the tooling, shown as the right picture:

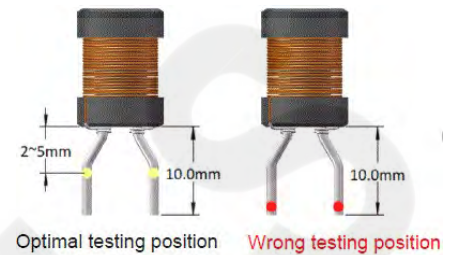

1. Inductance Test

There could be measurement deviations with different instruments due to different test principles / internal resistance. Open and Short compensation should be performed before testing. Select the measurement fixture or testing wire that goes with the original instrument.

2. Leakage Inductance Test

There could be measurement deviations with different instruments due to different test principles / internal resistance. Open and Short compensation should be performed before testing. Select the measurement fixture or testing wire that goes with the original instrument.

3. DCR Test

Shorten the testing wire as much as possible to ensure better contact between the products and the tooling; there would be deviations for the DCR if the testing tooling contact surface is worn out or if the testing method is not correct, especially for low DCR products.

4. Rated Current, Saturation Current, Temperature Rise Current

The saturation current is decided according to the initial inductance drop amount; the rated current is generally taken by the smaller value between the saturation current and temperature rise current.

5. Q Factor / SRF / Z Test

Shorten the pin length as much as possible to ensure better contact between the products and the tooling ;there can be deviation if the testing tooling contact surface is worn out or if the testing method is not correct.

6. Turns Ratio and Phase Test

There would be deviations for turn counts ratio when there is magnetic leakage or air gap in the core center, please pay attention to the differences during testing. If the air gap is too large, then use the planar cores for confirmation; be careful to choose the foot position when testing the polarity.

7. Hi-Pot Test

Choose AC or DC accordingly during Hi-pot testing since they are different. If the humidity is too high or there is pollution on the surface, the Hi-pot test might fail. Please avoid testing in high humidity condition and keep the tooling and products clean. The Hi-pot test is destructive test and repeat testing should be avoided.

8. IWT Test

Carefully choose the voltage and standard sample for the testing, IWT test is destructive testing and repeat testing should be avoided.

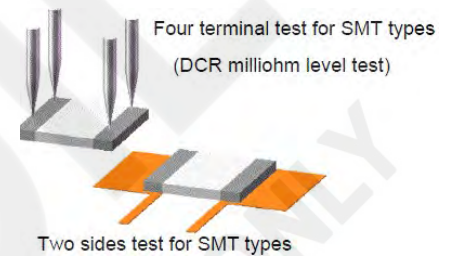

Please read cautions and warnings, important notes at the end of this document.

If you have any question, please contact 3L.