

Model	Output Current	Input Current	Input Power	Output Power Range	PF	Efficiency	Output Voltage	No load Voltage
LC60W120-550 DALI	120mA	0.15A	30.90W	6.48-28.80W	0.91	93.2%	54-240V	250V
	150mA	0.18A	38.13W	8.10-36.00W	0.93	94.4%	54-240V	250V
	200mA	0.23A	50.95W	10.80-48.00W	0.95	94.2%	54-240V	250V
	250mA	0.28A	63.62W	13.50-60.00W	0.97	94.3%	54-240V	250V
	300mA	0.28A	63.96W	16.20-60.00W	0.97	93.8%	54-200V	250V
	350mA	0.25A	56.33W	18.90-52.50W	0.96	93.2%	54-150V	250V
	400mA	0.28A	64.17W	21.60-60.00W	0.97	93.5%	54-150V	250V
	450mA	0.24A	53.19W	24.30-49.05W	0.96	92.2%	54-109V	250V
	500mA	0.27A	59.23W	27.00-54.50W	0.97	92.0%	54-109V	250V
	550mA	0.30A	65.30W	29.70-59.95W	0.97	91.8%	54-109V	250V

\* Test result @230V, 50Hz, Full Load

## 1. Parameters











category	Item	Technical Norm
Features	Output Type	Constant Current
	Dimming Type	DALI-2 / Touch DIM
	Output Features	Non-Isolation
	IP Grade	IP20
	Insulation Class	Class I
Input	Rated Input Voltage	220-240VAC
	Range of Input Voltage	198-264VAC
	Range of DC Input Voltage	180-280VDC
	Frequency	0/50/60Hz, Range:0/47-63Hz
	Input Current	≤0.30A max
	Input Power	≤65.30 W max

	Power Factor	≥0.97	(230VAC, full load)
	THD	≤8.5%	(230VAC, full load)
	Standby Power Consumption	≤0.45W	@ 230VAC(DIM to off)
	Inrush Current	≤10A/50us	(230VAC, full load)
	Connected quantity of 10A Breaker Connected quantity of 16A Breaker Connected quantity of 20A Breaker	19pcs/type A ;31pcs/type B ;50pcs/type C 31pcs/type A ;50pcs/type B ;80pcs/type C 39pcs/type A ;62pcs/type B ;100pcs/type C	
Output	Output Voltage	54-240VDC	
	No Load Voltage (Uout)	< 250VDC Max.	
	Output Current	120-550mA (Factory set current of 120mA)	
	Max. Output Power	60W	
	Efficiency	≥95%	(230VAC, full load@max current)
	Output LF current ripple (< 100 Hz)	<1%	(Imax-Imin) / (Imax+Imin)
	Current Accuracy	±5%	
	Output PstLM (at full load)	≤1	
	Output SVM (at full load)	≤0.4	
	Starting Time (AC mode)	≤0.8S	(230VAC, full load, by DALI system)
	Starting Time (DC mode)	≤0.4S	
	Switching over time (AC/DC)	≤0.4S	
Control Method	Secondary PUSH dimming	Secondary PUSH dimming (Max. lead wire length: 20m,same port of DALI)	
	PUSH-button	Max parallel connections qty for Push-dim 15	
	DALI function	DALI dimming (Max. lead wire length: 300m) logarithm or linear dimming curve selectable	
	Dimming range	DALI dimming: 1%-100%	
Protection	Short Circuit Protection	Auto Recovery	
	Overload Protection	Auto Recovery (not be hot swap)	
	No-load Protection	Auto Recovery	
	Insulation voltage	1500V 5mA 60S between P-E	
	Insulation resistance	>100M ohm @ 500VDC L/N to PE	
	Leakage current	< 700μA, I/P to O/P or I/P to PE @230V input	
Environment	Ta/Operation Temperature	-25....+60°C	
	Ts/Storage Temperature	-25....+85°C	
	Tc/Enclosure Temperature	85°C	
	Humidity	10%....90%RH	
	Atmosphere	86-108KPa	

Construction	Connection Method	Push-in Terminal
	Installation	Build-in
	PRI Wire preparation	0.5-1.5 <sup>□</sup> / 8-9mm
	SEC Wire preparation	0.5-1.5 <sup>□</sup> / 8-9mm
	DALI Wire preparation	0.5-1.5 <sup>□</sup> / 8-9mm
	Dimension	280*29.4*21mm (L*W*H)
Standards	Certification	CE/ENEC/SAA/UKCA/CB
	Safety Standards	EN61347-1:2015/A1:2021; EN61347-2-13:2014/A1:2017; EN62384:2006/A1:2009; AS 61347.2.13:2018; AS/NZS61347.1:2016; BS EN61347-1:2015/A1:2021; BS EN61347-2-13:2014/A1:2017; IEC 61347-2-13:2014; IEC 61347-1:2015
	EMC Standards	AS/NZS CISPR 15:2011; AS CISPR 15:2017;
	Performance	EN 62384
	DALI performance	EN 62386-101 (DALI-2) EN 62386-102 (DALI-2) EN 62386-207 (DALI-2, including part 251, 252, 253)
	Surge	L-N/1KV (L/N)-PE/2KV
Others	RoHS	2011/65/EU
	Life Time	50000h Tc=85°C
		75000h Tc=80°C
		100000h Tc=75°C
Warranty	5years , F.R. < 10000ppm	

Remark: 1.All Parameters, if not specified, are measured at 230VAC/50Hz and 25°C ambient temperature.  
2.LED Driver is a component of the luminaires, Luminaires and wire layout will affect the EMC, please check the EMC with end products again.  
3.During the PUSH DIM test, the number of parallel connections must be less than 15PCS.

## 2. Label

<input type="checkbox"/> L <input type="checkbox"/> N <input type="checkbox"/> DA <input type="checkbox"/> DA	 <b>KGP Electronics GmbH</b> Hueckstraße 19 DE-58511 Lüdenscheid	<b>LED Dimmable Driver</b> <b>LC60W120-550 DALI</b> Constant Current Type for operation with LED modules only Input Voltage:220-240VAC Input Frequency:0/50-60Hz Range of application DC 180-280V Output:120-550mA 54-240VDC	  Prange=6.4-60W Uout:250VDC Max.60W Tc:85°C Ta:60°C	<table border="1"> <thead> <tr> <th>Pout [W]</th> <th>Iout [mA]</th> <th>λ</th> <th>1</th> <th>2</th> <th>3</th> <th>4</th> <th>Pout [W]</th> <th>Iout [mA]</th> <th>λ</th> <th>1</th> <th>2</th> <th>3</th> <th>4</th> </tr> </thead> <tbody> <tr> <td>28.8</td> <td>120</td> <td>0.91C</td> <td>-</td> <td>-</td> <td>-</td> <td>-</td> <td>52.5</td> <td>350</td> <td>0.96</td> <td>-</td> <td>ON</td> <td>-</td> <td>ON</td> </tr> <tr> <td>36.0</td> <td>150</td> <td>0.93C</td> <td>-</td> <td>-</td> <td>-</td> <td>ON</td> <td>60.0</td> <td>400</td> <td>0.97</td> <td>-</td> <td>ON</td> <td>ON</td> <td>-</td> </tr> <tr> <td>48.0</td> <td>200</td> <td>0.95</td> <td>-</td> <td>-</td> <td>ON</td> <td>-</td> <td>45.0</td> <td>450</td> <td>0.96</td> <td>-</td> <td>ON</td> <td>ON</td> <td>ON</td> </tr> <tr> <td>60.0</td> <td>250</td> <td>0.97</td> <td>-</td> <td>-</td> <td>ON</td> <td>ON</td> <td>50.0</td> <td>500</td> <td>0.96</td> <td>ON</td> <td>-</td> <td>-</td> <td>-</td> </tr> <tr> <td>60.0</td> <td>300</td> <td>0.97</td> <td>-</td> <td>ON</td> <td>-</td> <td>-</td> <td>55.0</td> <td>550</td> <td>0.97</td> <td>ON</td> <td>-</td> <td>-</td> <td>ON</td> </tr> </tbody> </table>	Pout [W]	Iout [mA]	λ	1	2	3	4	Pout [W]	Iout [mA]	λ	1	2	3	4	28.8	120	0.91C	-	-	-	-	52.5	350	0.96	-	ON	-	ON	36.0	150	0.93C	-	-	-	ON	60.0	400	0.97	-	ON	ON	-	48.0	200	0.95	-	-	ON	-	45.0	450	0.96	-	ON	ON	ON	60.0	250	0.97	-	-	ON	ON	50.0	500	0.96	ON	-	-	-	60.0	300	0.97	-	ON	-	-	55.0	550	0.97	ON	-	-	ON	      	wire preparation 8-9mm Input: 0.5-1.5 <sup>□</sup> DALI: 0.5-1.5 <sup>□</sup> Output: 0.5-1.5 <sup>□</sup> Output + □ Output - □
Pout [W]	Iout [mA]	λ	1	2	3	4	Pout [W]	Iout [mA]	λ	1	2	3	4																																																																													
28.8	120	0.91C	-	-	-	-	52.5	350	0.96	-	ON	-	ON																																																																													
36.0	150	0.93C	-	-	-	ON	60.0	400	0.97	-	ON	ON	-																																																																													
48.0	200	0.95	-	-	ON	-	45.0	450	0.96	-	ON	ON	ON																																																																													
60.0	250	0.97	-	-	ON	ON	50.0	500	0.96	ON	-	-	-																																																																													
60.0	300	0.97	-	ON	-	-	55.0	550	0.97	ON	-	-	ON																																																																													

### 3. Output Current Setting

Output Current	1	2	3	4
120mA	-	-	-	-
150mA	-	-	-	ON
200mA	-	-	ON	-
250mA	-	-	ON	ON
300mA	-	ON	-	-
350mA	-	ON	-	ON
400mA	-	ON	ON	-
450mA	-	ON	ON	ON
500mA	ON	-	-	-
550mA	ON	-	-	ON

### 4. Dimension (Unit: mm)

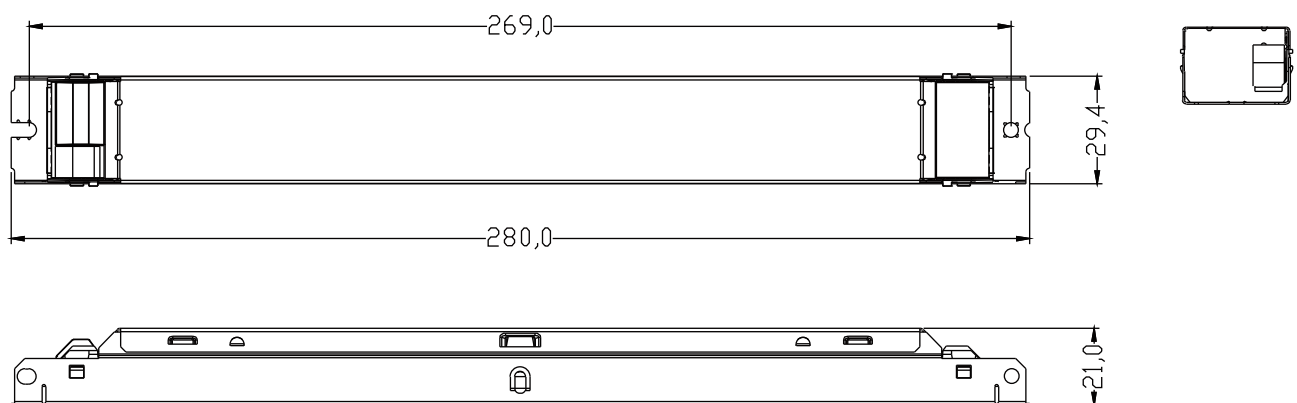

### 5. Installation / wiring

Circuit diagram

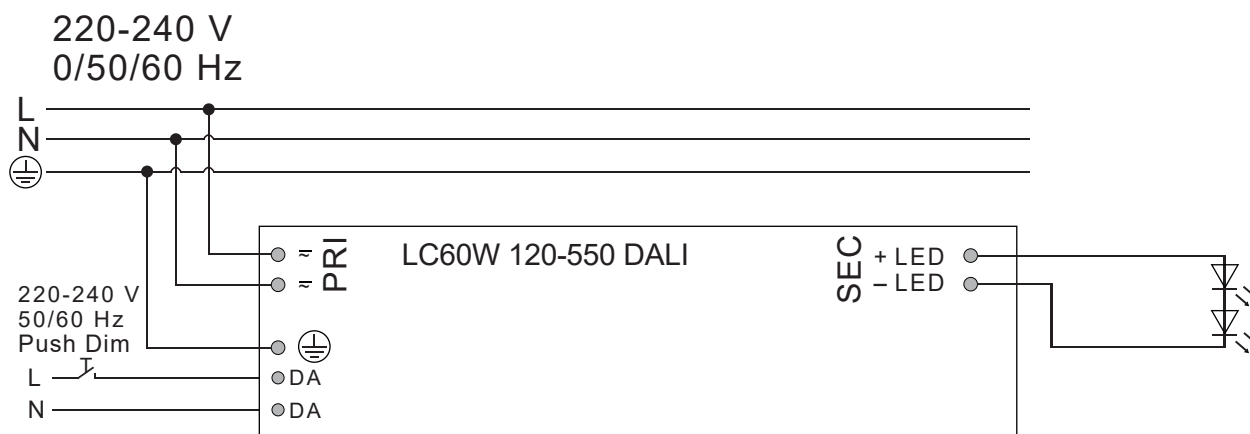
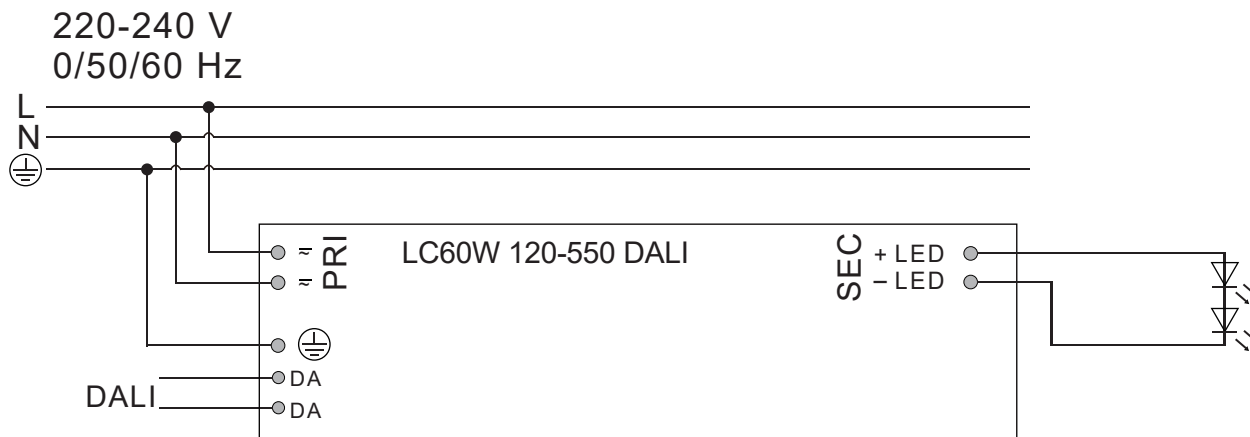

### 6. Output Power Window

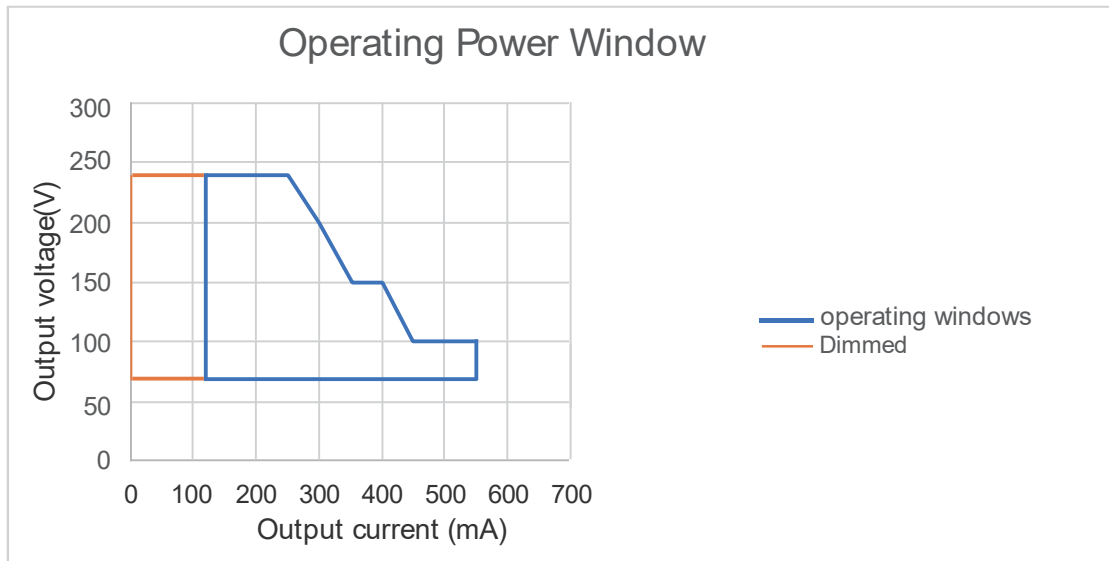

### 7. DALI dimming curve

formula for DALI dimming.

$$X(n) = 10^{\left\{ \frac{(n-1)}{(253/3)} - 1 \right\}}$$

Here, n means the target dimming stage of the total 254 stages.

X(n) means the percent of the maximum output current

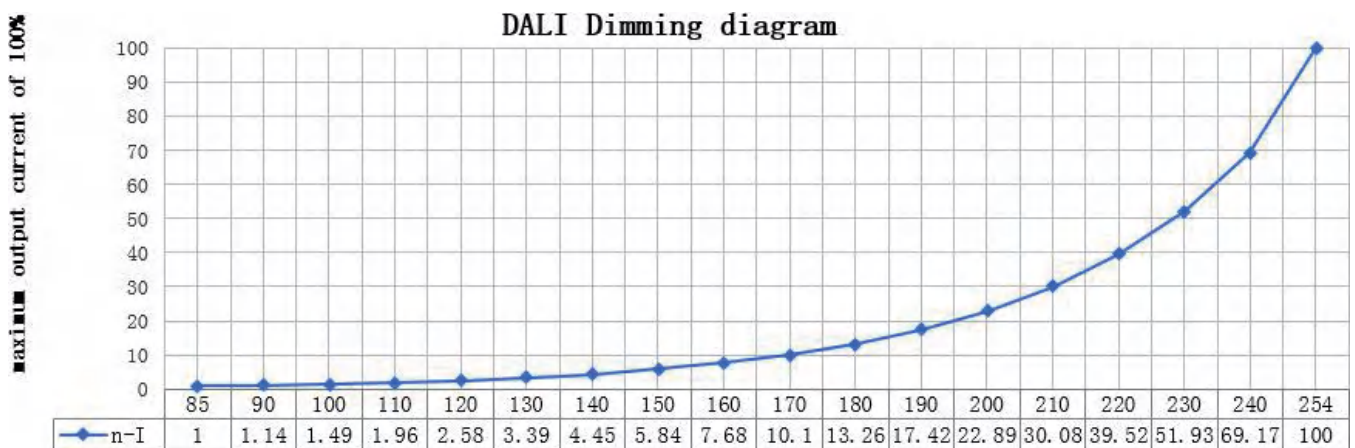

### 8. Packing information

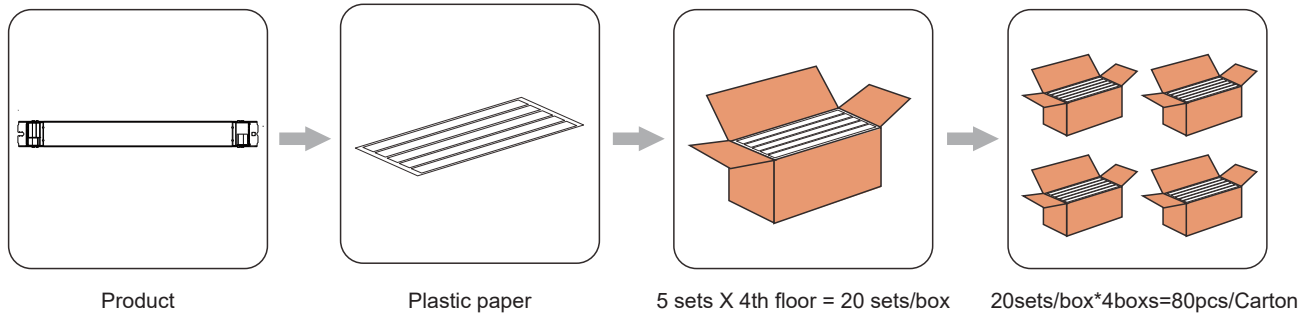

Carton L*W*H(mm)	Pcs/Carton	Net weight/ Pcs(kg)	Net weight/ Carton(kg)	Gross weight / Carton(kg)
325*303*213	80	0.135	10.80	11.84

### 9. Push Dim :

#### 9.1 On / off:

Short push (120ms-600ms) on the switch

Stepless dimming: long push (> 0.6sec) on the switch

#### 9.2 Power-on memory function

When the LED driver is powered on, it will restore the memory before the LED driver is powered off. (brightness remembers the brightness after the last dimming is stable, and the brightness during dimming is not memorized)

#### 9.3 Light on/off

If the light is on, the light will be off after a short press. If the light is off, the light will be on after a short press. The time range of short press is 120-600mS.

### 9.4 PUSH Dimming

Press and hold the push switch for a long time, the light will enter the dimming state, if the previous time is dimming, it will automatically turn to dimming the next time. After releasing the reset button, the dimming stops and the current illuminance is maintained. The dimming range is 1%-100%. The default is to dim when the power is first long-press. If the brightness of the power-on is the maximum brightness, the first long-press is to dim. (Long press 0.6-3S to start dimming.)

### 9.5 Forced synchronization

Long press for 10 seconds to turn on all the lights and turn on the same brightness (50%), and continue to quickly short press will not change. After a short period of time without short press operation, the module exits the synchronization mode, and the short press restores the switch function.

### 9.6 PUSH Dimming rate

Long press the push switch 10S to switch the dimming rate to 3S, Long press the push switch 20S to switch the dimming rate to 6S, and it can also be changed by MAGIC or production software.

## 10. REVISION HISTORY

Date	Revision	Remark
2023.11.03	V0.01	update images, Packing information