



Model	Output Current	Input Current	Input Power	Output Power Range	PF	Efficiency	Output Voltage	No load Voltage
LC35W150-700	150mA	0.13A	8.72W	3.00-7.50W	0.84	86.0%	20-50V	60V
	200mA	0.14A	11.49W	4.00-10.00W	0.85	87.0%	20-50V	60V
	250mA	0.15A	14.37W	5.00-12.50W	0.86	87.0%	20-50V	60V
	300mA	0.16A	17.05W	6.00-15.00W	0.87	88.0%	20-50V	60V
	350mA	0.17A	19.89W	7.00-17.50W	0.88	88.0%	20-50V	60V
	400mA	0.18A	22.73W	8.00-20.00W	0.89	88.0%	20-50V	60V
	450mA	0.19A	25.57W	9.00-22.50W	0.90	88.0%	20-50V	60V
	500mA	0.20A	28.41W	10.00-25.00W	0.91	88.0%	20-50V	60V
	550mA	0.21A	31.25W	11.00-27.50W	0.92	88.0%	20-50V	60V
	600mA	0.22A	34.09W	12.00-30.00W	0.93	88.0%	20-50V	60V
	650mA	0.23A	36.52W	13.00-32.50W	0.94	89.0%	20-50V	60V
	700mA	0.24A	39.33W	14.00-35.00W	0.95	89.0%	20-50V	60V

\* Test result @230V, 50Hz, Full Load













**1. Parameters**

category	Item	Technical Norm
Features	Output Type	Constant Current
	Output Features	Isolation
	IP Grade	IP20
	Insulation Class	Class I
Input	Rated Input Voltage	220-240VAC
	Range of Input Voltage	198-264VAC
	Range of DC Input Voltage	180-280VDC
	Frequency	0/50/60Hz, Range:0/47-63Hz
	Input Current	≤0.24A max
	Input Power	≤39.3W max
	Power Factor	≥0.95 (230VAC, full load)
	THD	≤8.5% (230VAC, full load)
	No-load Power Consumption	≤0.50W (230VAC, full load)
	Inrush Current	≤18A/15us (230VAC, full load)
	Connected quantity of 10A Breaker	11pcs/type A ; 17pcs/type B ; 28pcs/type C
Connected quantity of 16A Breaker	17pcs/type A ; 28pcs/type B ; 44pcs/type C	
Connected quantity of 20A Breaker	22pcs/type A ; 35pcs/type B ; 56pcs/type C	
Output	Output Voltage	20-50VDC@150-700mA
	No Load Voltage (Uout)	60VDC Max.
	Output Current	150-700mA (Factory set current of 150mA)
	Max. Output Power	35W
	Efficiency	≥89% (230VAC, full load@max current)
	Output LF current ripple (< 120 Hz)	±3% (Imax-Imin) / (Imax+Imin)
	Current Accuracy	±5%
	Output PstLM (at full load)	≤1
	Output SVM (at full load)	≤0.4
Starting Time (AC mode)	≤0.5S (230VAC, full load)	
Protection	Short Circuit Protection	Auto Recovery
	Overload Protection	Auto Recovery (not be hot swap)
	No-load Protection	Auto Recovery
	Insulation voltage	3000V 5mA 60S between P-S, 1500V 5mA 60S between P-E
	Insulation resistance	>100M ohm @ 500VDC L/N to PE
	Leakage current	< 700μA, I/P to O/P or I/P to PE @230V input
Environment	Ta/Operation Temperature	-25....+50°C
	Ts/Storage Temperature	-25....+80°C
	Tc/Enclosure Temperature	80°C
	Humidity	10%....90%RH
	Atmosphere	86-108KPa

Construction	Connection Method	Push-in Terminal
	Installation	Build-in
	PRI Wire preparation	0.5-1.5 <sup>□</sup> / 8-9mm
	SEC Wire preparation	0.5-1.5 <sup>□</sup> / 8-9mm
	Dimension	280*29.4*21mm (L*W*H)
Standards	Certification	CE/ENEC/SAA/UKCA/CB
	Safety Standards	EN61347-1:2015/A1:2021; EN61347-2-13:2014/A1:2017; EN62384:2006/A1:2009; AS 61347.2.13:2018; AS/NZS61347.1:2016; BS EN61347-1:2015/A1:2021; BS EN61347-2-13:2014/A1:2017; IEC 61347-2-13:2014; IEC 61347-1:2015
	EMC Standards	AS/NZS CISPR 15:2011; AS CISPR 15:2017 ;
	Performance	EN 62384
	Surge	L-N/1KV (L/N)-PE/2KV
Others	RoHS	2011/65/EU
	Life Time	50000h Tc=80°C
		75000h Tc=75°C
		100000h Tc=70°C
Warranty	5years , F.R. < 10000ppm	

Remark: 1.All Parameters, if not specified, are measured at 230VAC/50Hz and 25°C ambient temperature.  
 2.LED Driver is a component of the luminaires, Luminaires and wire layout will affect the EMC, please check the EMC with end products again.

## 2. Label

<input type="checkbox"/> L <input type="checkbox"/> N <input checked="" type="checkbox"/> ⊕ wire preparation 8-9mm PRI: 0.5-1.5 <sup>□</sup> SEC: 0.5-1.5 <sup>□</sup>	 <b>KGP</b> KGP Electronics GmbH Hueckstraße 19 DE-58511 Lüdenscheid	<b>LED Driver</b> <b>LC35W150-700</b> Constant Current Type for LED Only Input Voltage:220-240VAC Iin:≤0.24A Input Frequency:0/50-60Hz Prange=3-35W Range of application Uout:60VDC Max.35W DC 180-280V Tc:80°C Ta:50°C SEC:150-700mA 20-50VDC	          	<table border="1"> <thead> <tr> <th>Pout [W]</th> <th>Iout [mA]</th> <th>λ</th> <th>1</th> <th>2</th> <th>3</th> <th>4</th> <th>Pout [W]</th> <th>Iout [mA]</th> <th>λ</th> <th>1</th> <th>2</th> <th>3</th> <th>4</th> </tr> </thead> <tbody> <tr> <td>7.5</td> <td>150</td> <td>0.84C</td> <td>-</td> <td>-</td> <td>-</td> <td>-</td> <td>22.5</td> <td>450</td> <td>0.90C</td> <td>-</td> <td>ON</td> <td>ON</td> <td>-</td> </tr> <tr> <td>10.0</td> <td>200</td> <td>0.85C</td> <td>-</td> <td>-</td> <td>ON</td> <td>-</td> <td>25.0</td> <td>500</td> <td>0.91C</td> <td>-</td> <td>ON</td> <td>ON</td> <td>ON</td> </tr> <tr> <td>12.5</td> <td>250</td> <td>0.86C</td> <td>-</td> <td>-</td> <td>ON</td> <td>-</td> <td>27.5</td> <td>550</td> <td>0.92C</td> <td>ON</td> <td>-</td> <td>-</td> <td>-</td> </tr> <tr> <td>15.0</td> <td>300</td> <td>0.87C</td> <td>-</td> <td>-</td> <td>ON</td> <td>ON</td> <td>30.0</td> <td>600</td> <td>0.93C</td> <td>ON</td> <td>-</td> <td>-</td> <td>ON</td> </tr> <tr> <td>17.5</td> <td>350</td> <td>0.88C</td> <td>-</td> <td>ON</td> <td>-</td> <td>-</td> <td>32.5</td> <td>650</td> <td>0.94C</td> <td>ON</td> <td>-</td> <td>ON</td> <td>-</td> </tr> <tr> <td>20.0</td> <td>400</td> <td>0.89C</td> <td>-</td> <td>ON</td> <td>-</td> <td>ON</td> <td>35.0</td> <td>700</td> <td>0.95</td> <td>ON</td> <td>-</td> <td>ON</td> <td>ON</td> </tr> </tbody> </table>	Pout [W]	Iout [mA]	λ	1	2	3	4	Pout [W]	Iout [mA]	λ	1	2	3	4	7.5	150	0.84C	-	-	-	-	22.5	450	0.90C	-	ON	ON	-	10.0	200	0.85C	-	-	ON	-	25.0	500	0.91C	-	ON	ON	ON	12.5	250	0.86C	-	-	ON	-	27.5	550	0.92C	ON	-	-	-	15.0	300	0.87C	-	-	ON	ON	30.0	600	0.93C	ON	-	-	ON	17.5	350	0.88C	-	ON	-	-	32.5	650	0.94C	ON	-	ON	-	20.0	400	0.89C	-	ON	-	ON	35.0	700	0.95	ON	-	ON	ON	SEC +□ 1 □ 
				Pout [W]	Iout [mA]	λ	1	2	3	4	Pout [W]	Iout [mA]	λ	1	2	3	4																																																																																						
7.5	150	0.84C	-	-	-	-	22.5	450	0.90C	-	ON	ON	-																																																																																										
10.0	200	0.85C	-	-	ON	-	25.0	500	0.91C	-	ON	ON	ON																																																																																										
12.5	250	0.86C	-	-	ON	-	27.5	550	0.92C	ON	-	-	-																																																																																										
15.0	300	0.87C	-	-	ON	ON	30.0	600	0.93C	ON	-	-	ON																																																																																										
17.5	350	0.88C	-	ON	-	-	32.5	650	0.94C	ON	-	ON	-																																																																																										
20.0	400	0.89C	-	ON	-	ON	35.0	700	0.95	ON	-	ON	ON																																																																																										

### 3. Output Current Setting

Output Current	1	2	3	4
150mA	-	-	-	-
200mA	-	-	-	ON
250mA	-	-	ON	-
300mA	-	-	ON	ON
350mA	-	ON	-	-
400mA	-	ON	-	ON
450mA	-	ON	ON	-
500mA	-	ON	ON	ON
550mA	ON	-	-	-
600mA	ON	-	-	ON
650mA	ON	-	ON	-
750mA	ON	-	ON	ON

### 4. Dimension (Unit: mm)

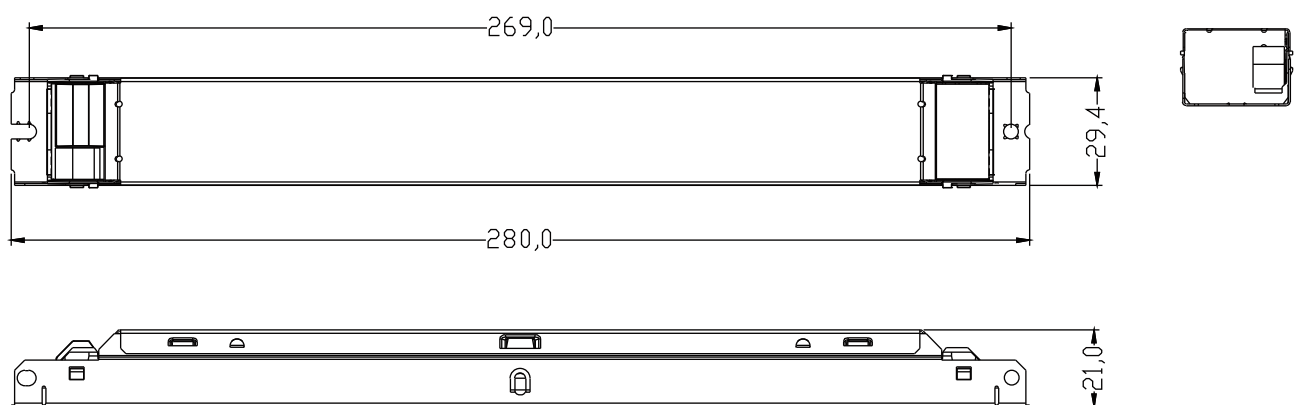

### 5. Installation / wiring

Circuit diagram

220-240 V  
0/50/60 Hz

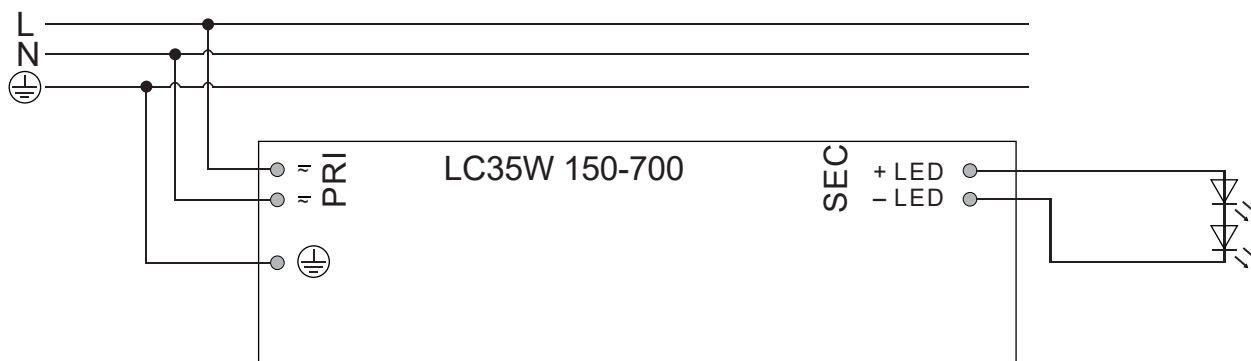

### 6. Output Power Window

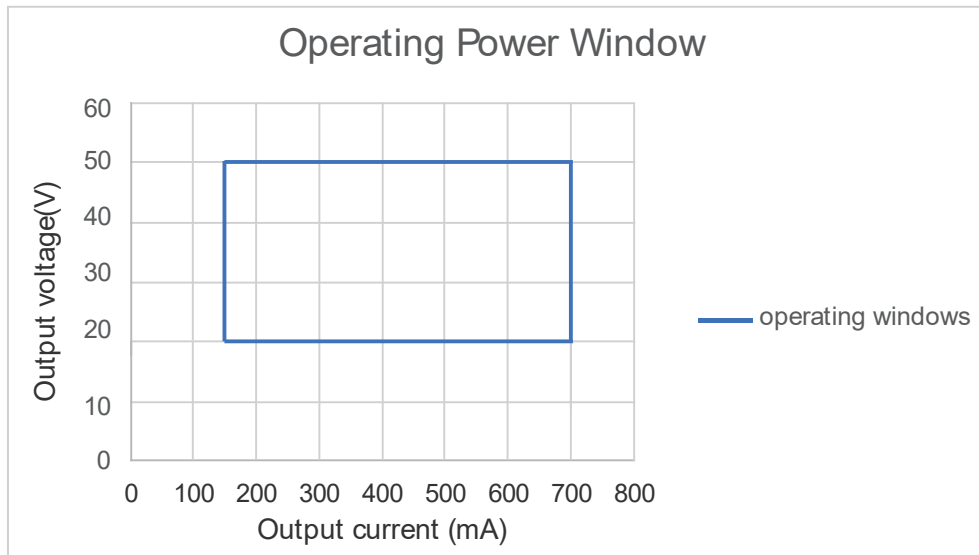

### 7. Packing information

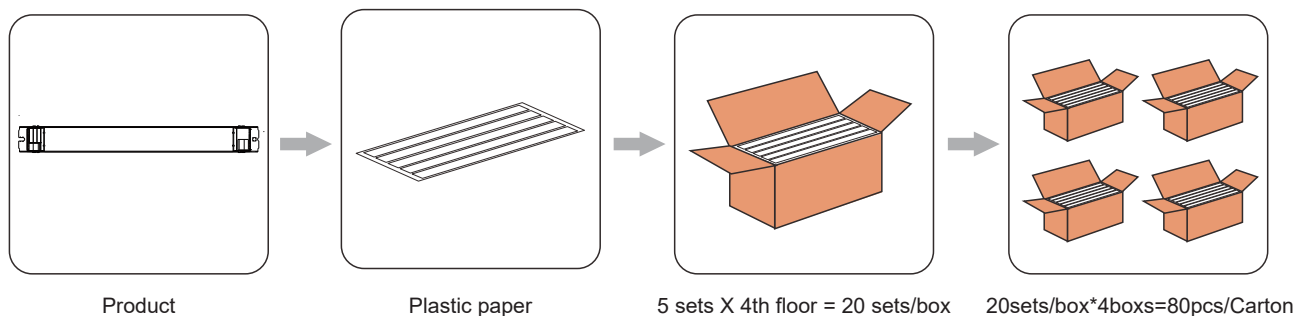

Carton L*W*H(mm)	Pcs/Carton	Net weight/ Pcs(kg)	Net weight/ Carton(kg)	Gross weight / Carton(kg)
325*303*213	80	0.164	13.12	13.72

### 8. REVISION HISTORY

Date	Revision	Remark
2023.11.02	V0.01	update images, Packing information