



PRODUCT FEATURES

- Universal input voltage: 90-305Vac;
- Constant current design; Efficiency up to 95%;
- Isolated dimming: DALI-2 dimming;
- Dim-to-off; No glimmer after Dim-to-off;
- Flicker free: Total Output Current Ripple 5%;
- Surge protection: 4KV line-line, 6KV line-earth;
- Multiple protection: SCP, OVP, OTP;
- IP65 design for indoor and outdoor applications;
- 5 years warranty.

APPLICATION

- Suitable for industrial lighting.

DESCRIPTION

G6-240W DALI series is specially designed for industrial lighting applications. It is constant current LED driver that operates from 90-305Vac with DALI-2 dimming function. This round integrated structure enables it to have a better heat dissipation cooler, significantly improving reliability and extending product life. To ensure trouble free operation, protection is provided against input surge, output over voltage, short circuit, and over temperature.

MODELS

Model Number	Max Output Power (W)	Output Voltage Range (Vdc)	Output Current Adjustable Range (A)	Full Power Current Adjustable Range (A) [1]	Default Output Specification	Typical Efficiency [2]	Power Factor	
							120Vac	230Vac
G6-240D260H	240	180-260	0.87-1.10	0.92-1.10	180-218V/1.10A	95%	0.99	0.96

Notes:

1. Output current adjustable range with constant power at max output power;
2. All specifications are measured at 25°C ambient temperature, input voltage 230Vac, and the typical value tested by full load, if no specific note.

OPERATING AREA I-V

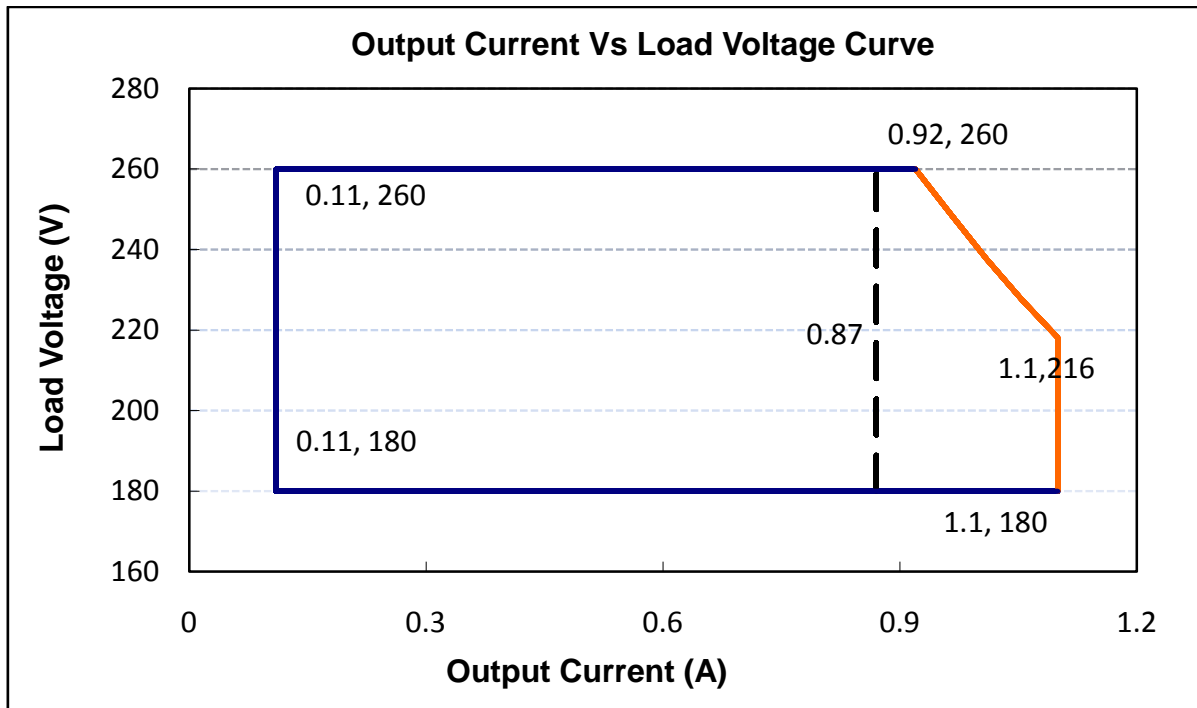

Notes: Adjustable range of resistance is suitable for the right area of the dotted line.

The drivers are not allowed to work in over-load condition, otherwise warranty will expire.

INPUT SPECIFICATIONS

Parameter	Min.	Typ.	Max.	Notes
Input Voltage	90Vac	100-277Vac	305Vac	
Input Frequency	47Hz	50/60	63Hz	
Leakage Current	-	-	0.75mA	277Vac/60Hz
Input AC Current	-	-	3.3A	100-277Vac & full load
Inrush Current(I ² T)	-	-	1.5A ² S	230Vac, full load
Power Factor	0.98	0.99	-	120Vac, full load
	0.95	0.96	-	230Vac, full load
	0.91	0.92	-	277Vac, full load
THD	-	5%	10%	120-240Vac, 80%-100% load
	-	7%	15%	277Vac, 80%-100% load

OUTPUT SPECIFICATIONS

Parameter	Min.	Typ.	Max.	Notes
Output Current Tolerance	-8%	-	+8%	
Output Current Range (A)	0.87	-	1.10	
Total Output Current Ripple (pk-pk)	-	5%	10%	20MHz BW, 100% Load & load is LED, ripple is different with difference LED load
Startup Overshoot Current	-	-	10%	100-277Vac & 100% Load, load is LED
No Load Output Voltage(V)	-	290V	320V	
Standby Power			0.5W	Dim-to-off
Line Regulation	-1%	-	+1%	25°C±10°C ambient temperature, input voltage changes from 100Vac to 277Vac
Load Regulation	-3%	-	+3%	25°C±10°C ambient temperature, 230Vac input, load changes from 80% to 100%.
Turn-on Delay Time	-	-	1.0S	120Vac, 100% load
	-	-	1.0S	230Vac, 100% load

GENERAL SPECIFICATIONS

Parameter	Min.	Typ.	Max.	Notes
Efficiency @120Vac	91%	93%	-	25°C±10°C ambient temperature, 100% load,
Efficiency @230Vac	93%	95%	-	25°C±10°C ambient temperature, 100% load,
Efficiency @277Vac	93%	95%	-	25°C±10°C ambient temperature, 100% load,
Dielectric Strength	Input-PE	-	1650Vac	5mA/60S
	Output- PE	-	-	
Grounding Resistance	-	-	0.1Ω	25A/60S
Insulation Resistance	10MΩ	-	-	Input-PE, Output-PE, 500Vdc/60S/25°C/70%RH
MTBF	-	200000Hrs	-	25°C±10°C ambient temperature, 230Vac, 80% load (MIL-HDBK-217F)
Lifetime	-	50000Hrs	-	230Vac & 100% load, 75°C case temperature, refer to lifetime VS Tc curve for details
Operating Case Temperature for Safety Tc_s	-40°C	-	+90°C	
Operating Case Temperature for Warranty Tc_w	-40°C	-	+75°C	5 years warranty Humidity: 10% to 95% RH
Storage Temperature	-40°C	-	+85°C	Humidity: 5% to 100% RH
Dimensions (D×H)mm	Φ130×64.6			
Net Weight	950±150g/PCS			
Package	L490*W370*H185mm; 12PCS/Ctn.			

DIMMING

Parameter	Min.	Typ.	Max.	Parameter
High Voltage Level	9.5V	16V	22.5V	
Lower Voltage Level	-6.5V	0V	6.5V	
Dimming Output Range	10%Imax	-	100%Imax	Imax=1.10A; Dim to off <10%
Sink Current	-	-	2.0mA	

SAFETY STANDARDS

Safety Category	Country / Territory	Standards	Whether have Certification
CCC	China	GB19510.1, GB19510.14	√
CE	Europe	EN61347-1, EN61347-2-13	√
		EN62493	√
ENEC		EN62384	√
CB		CB Countries	IEC61347-1, IEC61347-2-13
BIS	India	IS 15885(PART 2/SEC 13)	
UL	USA	UL 8750	
CUL	Canada	CSA C22.2 No.250.13	
KC	South Korea	K61347-1, K61347-2-13	
PSE	Japan	J61347-1, J61347-2-13	
SAA	Australia	AS/NZS IEC 61347.2.13	√
		AS/NZS 61347.1	√

EMC COMPLIANCE

EMC Category	Country / Territory	Standards	Whether have Certification
CCC	China	GB/T 17743, GB 17625.1	√
CE	Europe	EN 55015	√
		EN 61000-3-2, EN 61000-3-3	√
		EN61000-4-2,3,4,5,6,11	√
		EN 61547	√
KC	South Korea	K61547, K00015	
PSE	Japan	J55015	
FCC	USA	FCC part 15	

NOTE:

This LED driver meets the EMI specifications above, but EMI performance of a luminaire that contains it depends also on the other devices connected to the driver and on the fixture itself.

INRUSH CURRENT WAVEFORM

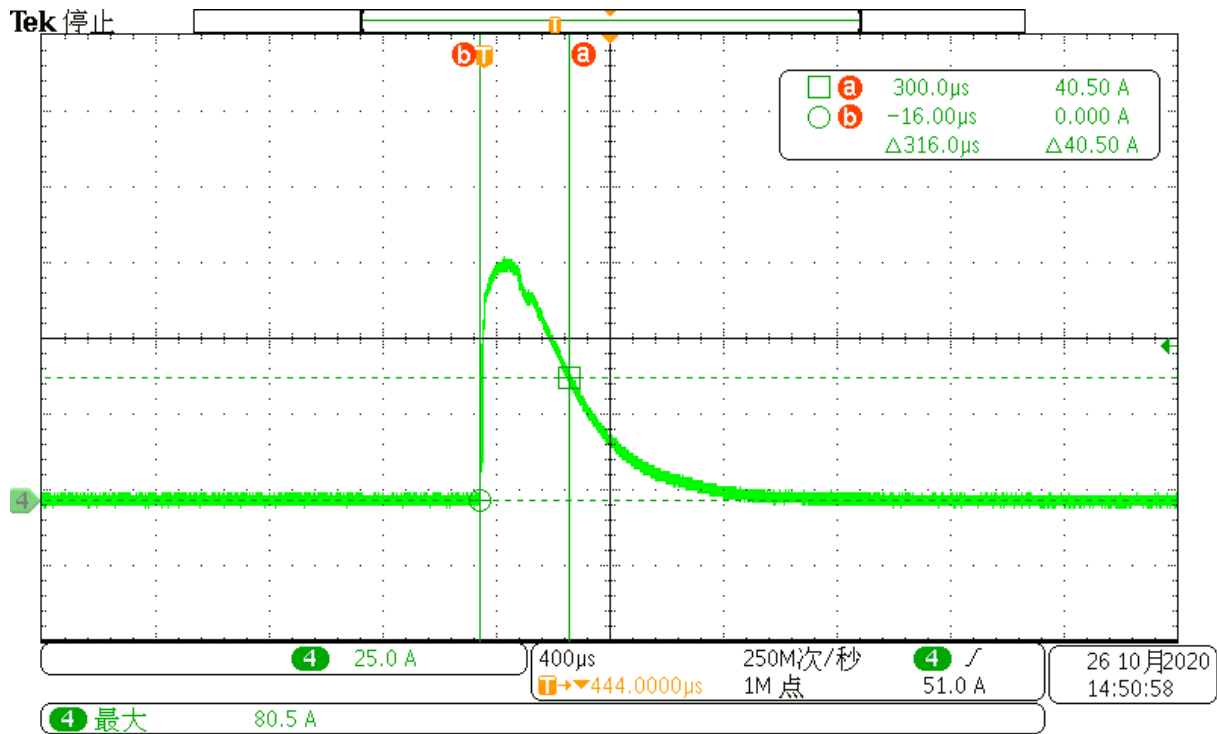

DERATING CURVE

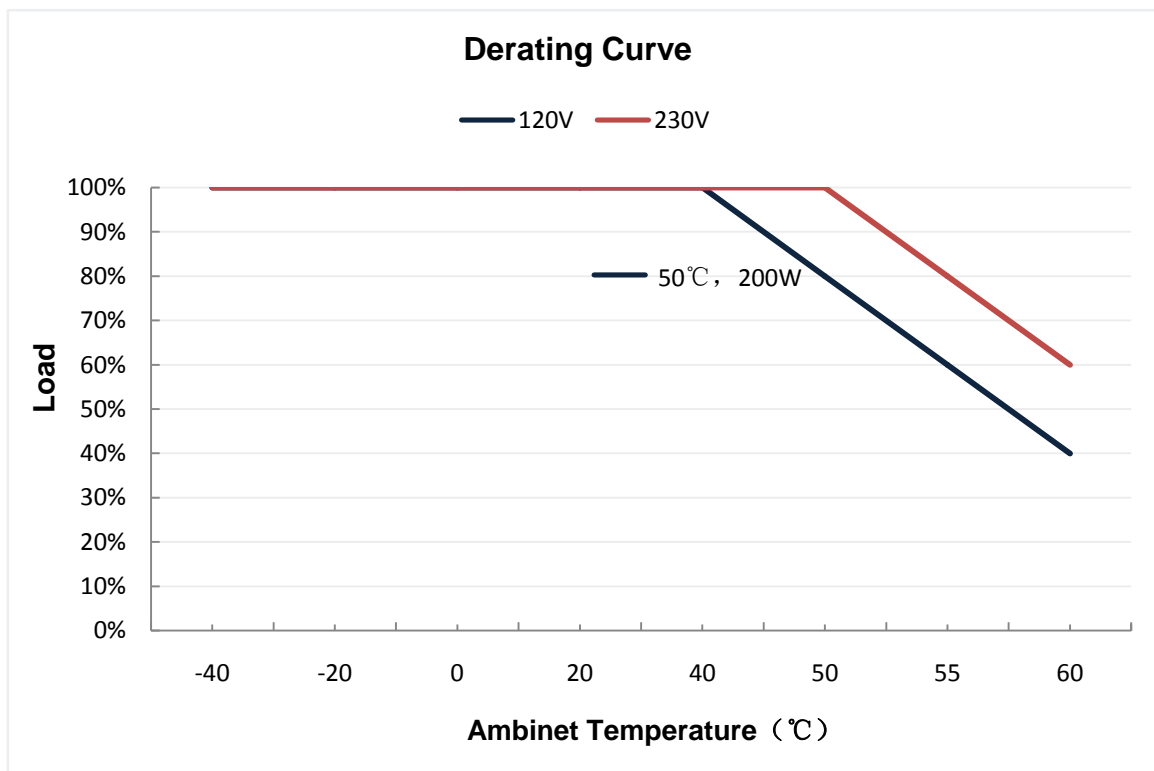

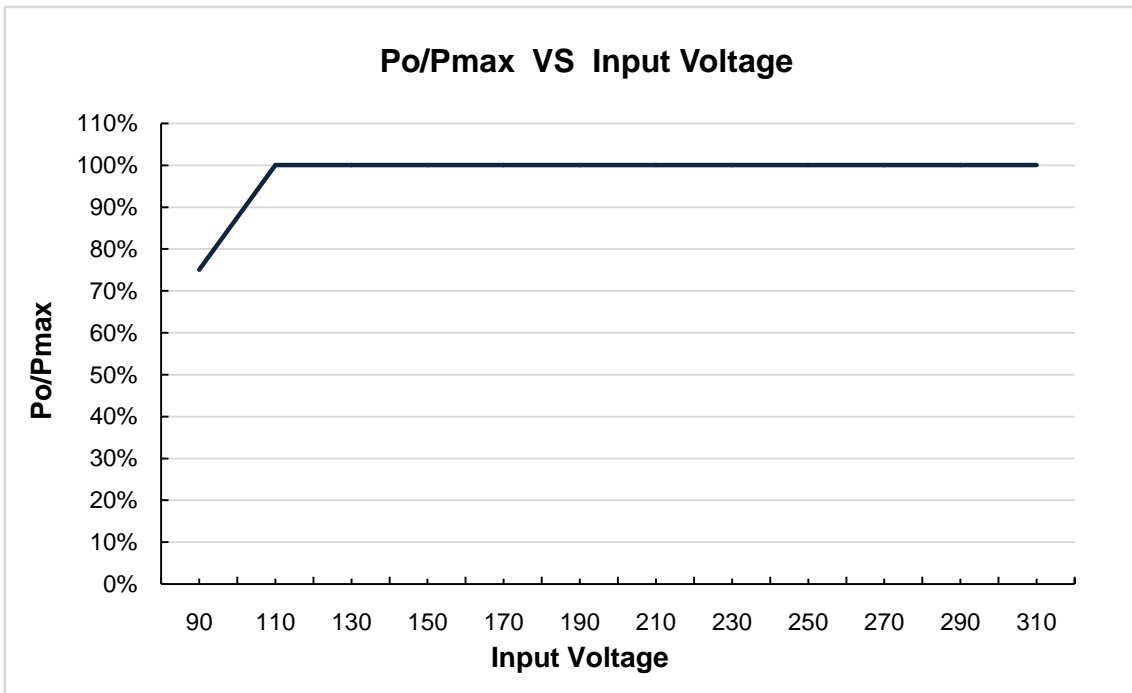
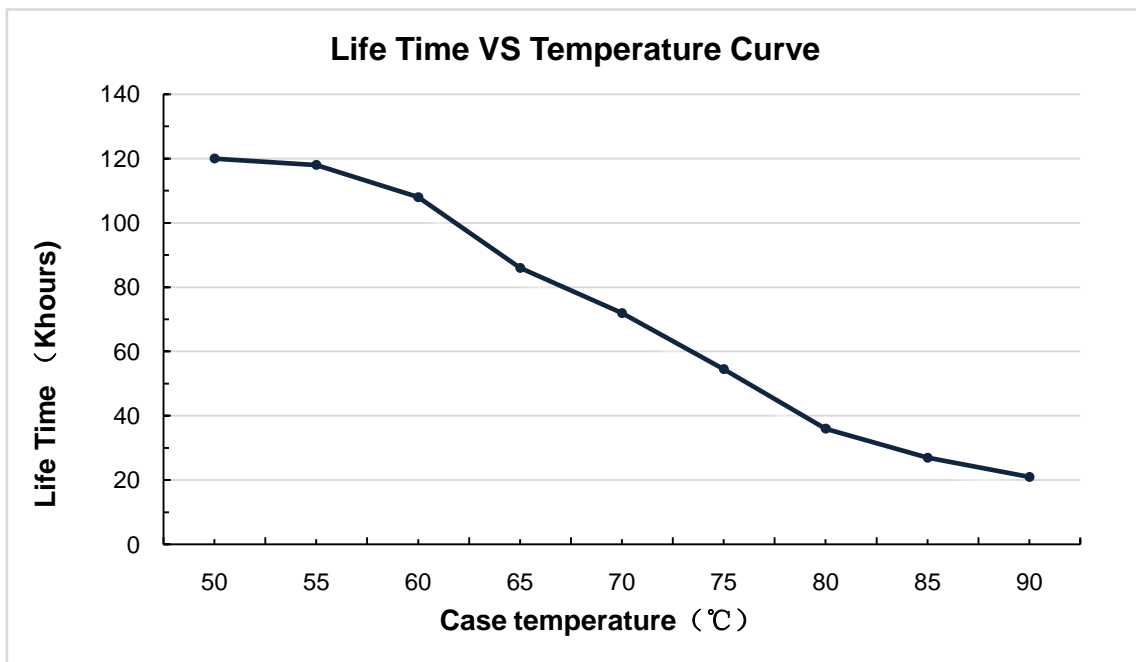
OUTPUT POWER VS INPUT VOLTAGE**LIFETIME VS CASE TEMPERATURE**

EFFICIENCY VS LOAD

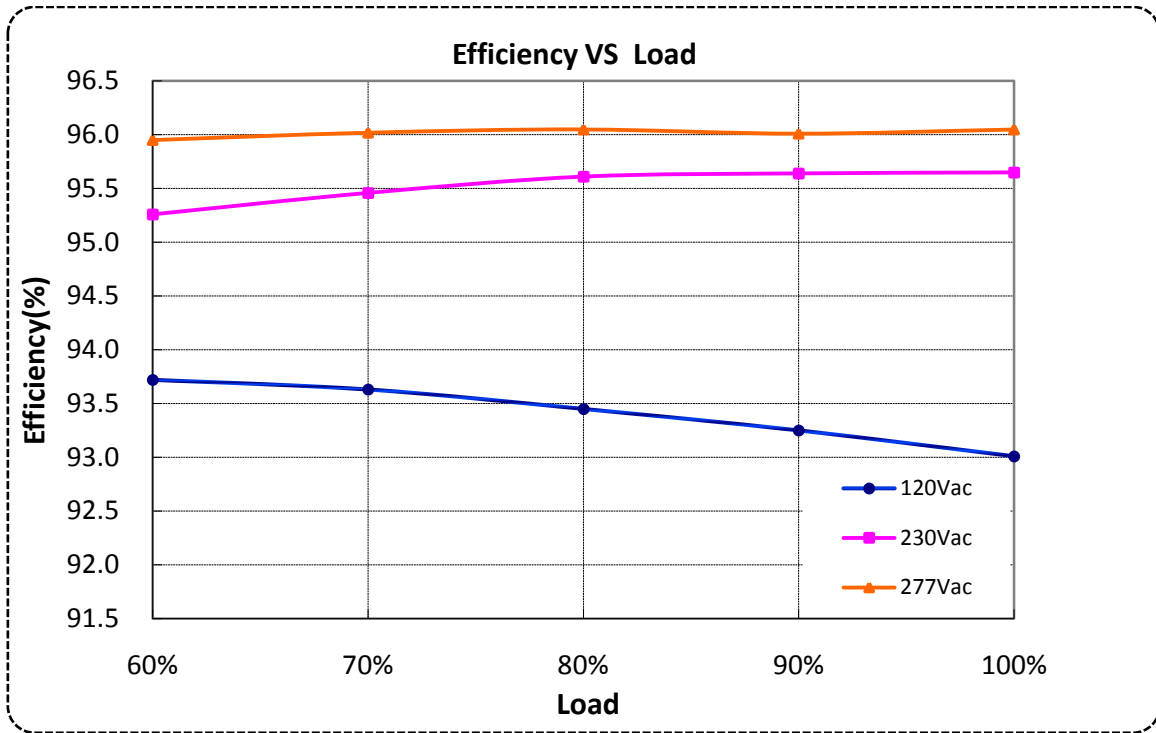

POWER FACTOR VS LOAD

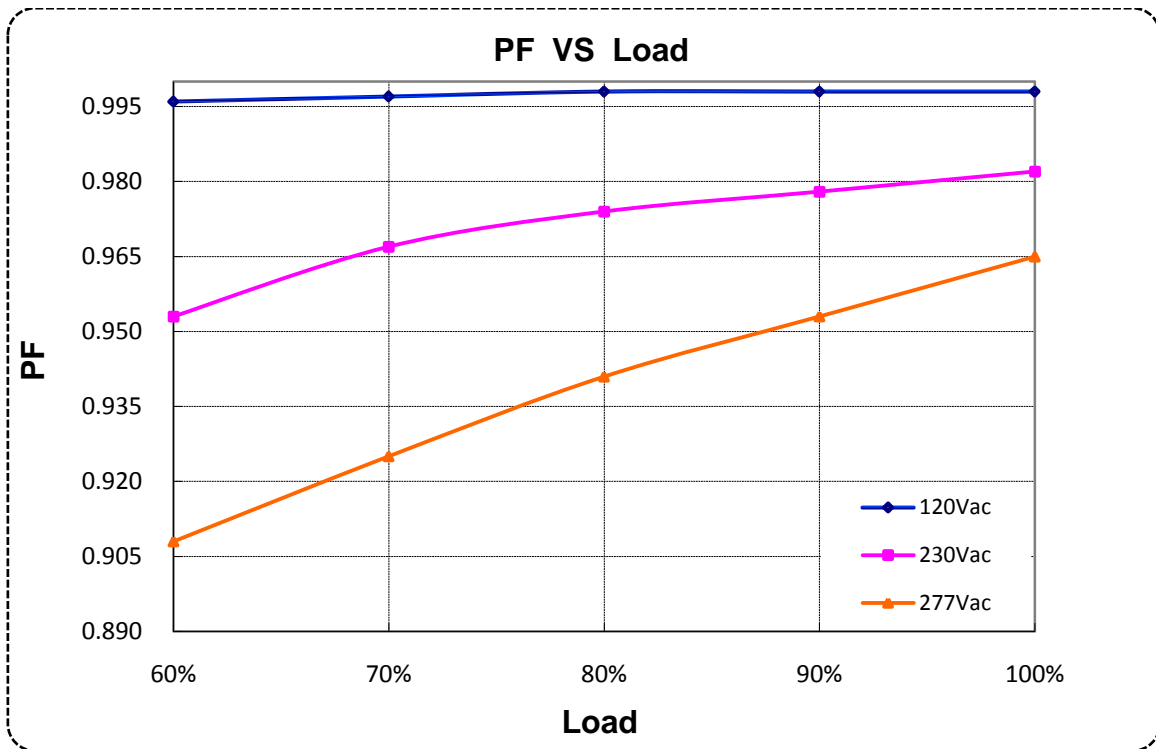

TOTAL HARMONIC DISTORTION

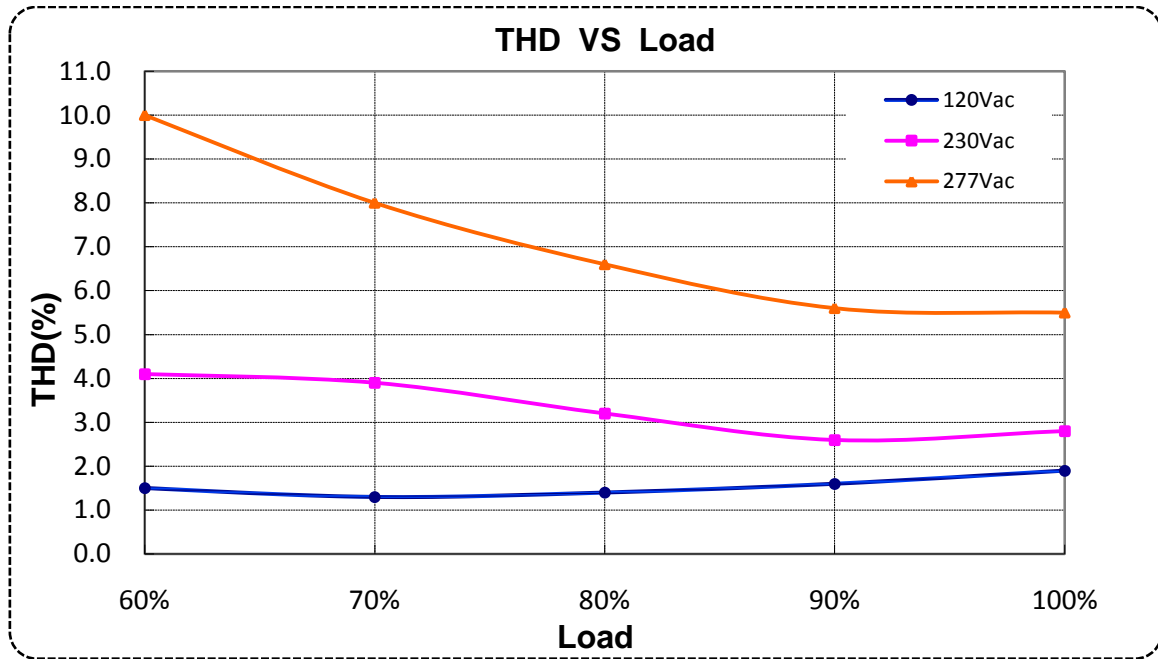

PROTECTIONS

Parameter	Notes
Over Temperature Protection	Decreases output current, returning to normal after over temperature is removed, exclude auxiliary power supply.
Short Circuit Protection	Hiccup mode and auto recovery. No damage will occur when any output is short circuited. The output shall return to normal when the fault condition is removed.
Over Voltage Protection	Run into protection model when output voltage exceeds limit, and return to normal when the fault.

DALI-2 DIMMING CURVE

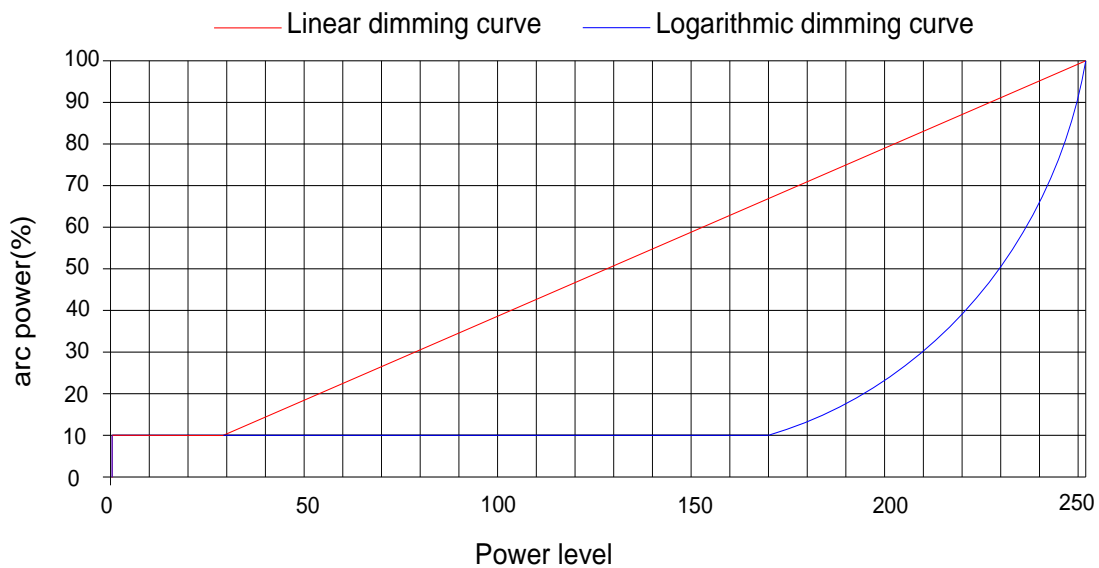

Note: Factory Default Output Logarithmic Curve

MECHANICAL OUTLINE

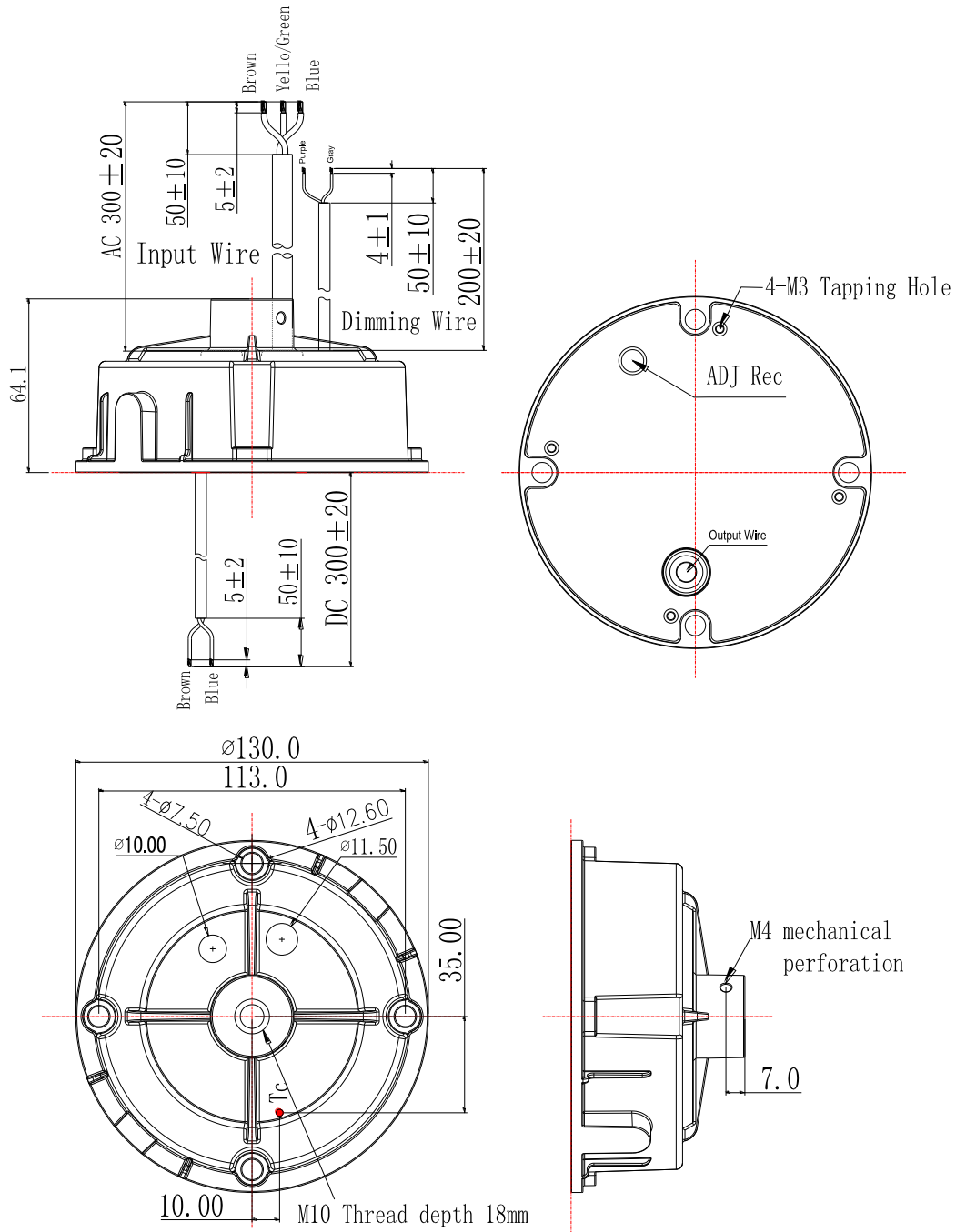

Note: Case color: RAL 9017 matte black.

Wire	Specification	Note
Input	CCC+VDE 3x1.0mm ² L=300±20mm	CCC/CE
Output	CCC+VDE 2x1.0mm ² L=300±20mm	CCC/CE
Dimming	22AWG*2C L=200±20mm	

Product Specification

Product Name: 240W Non-isolated DALI-2 LED Driver

Product Model: G6-240D260H

Rev.: A.3

XiLiSongbai Road 1061,
Address: Nanshan District, Shenzhen City,
Guangdong Province, P.R.China

Post Code: 518108

TEL: 0755-27657000

FAX: 0755-27657908

E-mail: info@mosopower.com

Web site: <http://www.mosopower.com>

Prepared By	Checked By	Approved By

Specification for Approval

Product Name: 240W Non-isolated DALI-2 LED Driver

Product Model: G6-240D260H

Rev.: A.3

CUSTOMER AUTHORIZED SIGNATURE		
Tested By	Checked By	Approved By
(Company seal)Return one copy to MOSO with approved signature and company seal.		

Prepared By	Checked By	Approved By