

---

## Specification for Approval

Product Name: 240W High Bay Driver

Product Model: G6-240D260H (II)

Rev. A.0

Address: Xi Li Song bai Road 1061, Nanshan District, Shenzhen City, Guangdong Province, P.R. China

Post Code: 518108

TEL: 0755-27657000

FAX: 0755-27657908

E-mail: [info@mosopower.com](mailto:info@mosopower.com)

Web site: <http://www.mosopower.com>

Prepared By	Checked By	Approved By

## Specification for Approval

Product Name: 240W High Bay Driver

Product Model: G6-240D260H ( II )

Rev.: A.0

CUSTOMER AUTHORIZED SIGNATURE		
Tested By	Checked By	Approved By
(Company seal) Return one copy to MOSO with approved signature and company seal		

Address: Xi Li Song bai Road 1061, Nanshan District, Shenzhen City, Guangdong Province, P.R. China

Post Code: 518108

TEL: 0755-27657000 FAX: 0755-27657908

E-mail: [info@mosopower.com](mailto:info@mosopower.com) Web site: <http://www.mosopower.com>

Tested By	Checked By	Approved By

---

### ECN History

---

A.0	First edition	2024-10-22

## Description

G6D-(II) D4i series is specially designed for industrial lighting applications. They are constant current LED drivers that operates from 90-305Vac with excellent power factor. G6D-(II) D4i series provides integrated AC power monitoring, an auxiliary DC output and dim-to-off function, for powering low-voltage wireless controllers. The dimming control supports two-way communication via DALI-2 and complies with D4i. This round integrated structure enables better heat dissipation, significantly improving reliability and extending product lifetime. Overall protection is provided against input surge, output over voltage, short circuit, and over temperature to ensure high reliability.



## Product Features

- Universal input voltage / Full range: 90~305Vac;
- output current programming adjustable, Efficiency up to 96%;
- DALI-2 & D4i Certified;
- Integrated 16Vdc Bus Power Supply Based on DALI-2;
- Auxiliary power supply: 24V/125mA;
- Standby Power Consumption <0.5W;
- Surge protection: DM: 6KV, CM: 6KV;
- Protections: Input UVP/OVP, output SCP/OVP/OTP;
- Ingress protection rating: IP65;
- 5 years warranty;

## Application

Suitable for industrial lighting.

## Models

Model	Input Voltage (Vac)	MAX Output Power (W)	Output Voltage (Vdc)	Output Current Adjustable Range (A)	Default Current (A)	Eff. (Typ.)	PF(Typ.)	THD(Typ.)
G6-240D260H (II)	90~305	240	180~260	0.60~1.10	1.0	96%	0.97	10%

Notes:

All specifications are measured at 25°C ambient temperature, input voltage 230Vac, and the typical value tested at full load, if no specific note.

## Optional Model Features

Model	Adjustable power( single DIP)	Color temperature (single DIP)
G6-240D260H ( II )	-	√

## Input Specifications

Parameter	Min.	Typ.	Max.	Notes
Input Voltage Range	90Vac	-	305Vac	
Rated Input Voltage	100Vac	-	277Vac	Refer to Output Power vs. Input Voltage Curve
Input Frequency AC	47Hz	50/60Hz	63Hz	
Max Input Current	-	-	2.8A	120Vac&100% load
Max Input Power	-	-	280W	120Vac&100% load
Leakage	-	-	0.70mA	IEC 60598-1; 240Vac/50Hz
Inrush Current	-	-	100A	220Vac, 100% load ,Cold Start
Standby Power Consumption	-	-	0.5W	230Vac&50Hz, no load on auxiliary output and 16Vdc bus power supply is off
Power Factor	0.95	0.97	-	230Vac, 50/60Hz, 100% load
	0.90	-	-	120-277Vac, 50/60Hz, 70%-100% load
THD	-	8%	10%	230Vac, 50/60Hz, 100% load
	-	-	20%	120-277Vac, 50/60Hz, 70%-100% load
MCB(B16)	-	7	-	220Vac; 100% load

## Output Specifications

Parameter	Min.	Typ.	Max.	Notes
Output Voltage Range	180Vdc	-	260Vdc	
Open Circuit Voltage	-	-	310Vdc	
Output Current Adjustable Range	0.60A	-	1.10A	Adjustable output current with potentiometer
Output Current Adjustable Range	0.11A	-	1.10A	Adjustable Output Current with programmer
Full Power Current Range	0.92A	-	1.10A	216-260Vdc
Current Accuracy	-8%	-	+8%	
Total Output Current Ripple (pk-pk)	-	10%	15%	20MHz BW full load&LED load, the ripple is slightly different for different leds
Startup Overshoot Current	-	-	10%	120-277Vac full load condition, LED load
Line Regulation	-5%	-	+5%	25°C±10°C ambient temperature, input voltage changes from 120Vac to 277Vac
Load Regulation	-5%	-	+5%	25°C±10°C ambient temperature, 230Vac input, load changes from 70% to 100%
Turn-on Delay Time	-	1.0s	1.5s	120-277Vac, 100% load
Power Monitoring Accuracy	-5%	-	5%	230Vac, 100% load

## General Specification

Parameter	Min.	Typ.	Max.	Notes
Efficiency @120Vac	92%	93%	-	1.0A, 240Vdc; 25°C ambient temperature, no load on auxiliary output
Efficiency @230Vac	93%	96%	-	1.0A, 240Vdc; 25°C ambient temperature, no load on auxiliary output
Efficiency @277Vac	94%	96%	-	1.0A, 240Vdc; 25°C ambient temperature, no load on auxiliary output
MTBF	-	200Khours	-	25°C±10 ambient temperature, 230Vac, 80% load (MIL-HDBK-217/SR-332)
Lifetime	-	50Khours	-	230Vac&100% load, Tc 75°C, refer to lifetime vs. case temperature curve
Operating Temperature Ta	-40°C	-	+50°C	
Operating Case Temperature for Safety Tc_s	-40°C	-	+90°C	
Operating Case Temperature for Warranty Tc_w	-40°C	-	+75°C	5 years warranty case temperature Humidity: 10%-90% RH
Storage Temperature Ta	-40°C	-	+85°C	Humidity: 5%-95% RH
Altitude	-60m	-	4000m	
Over Temperature Protection Tc	90°C	95°C	100°C	Decreases output current, returning to normal after over temperature condition is removed
Input Under voltage Protection	70Vac	80Vac	88Vac	Turn off the output when the input voltage falls below protection voltage. When the input voltage exceeds the recovery voltage, the driver will restart automatically.
Input Over voltage Protection	305Vac	325Vac	345Vac	Turn off the output when the input voltage exceeds protection voltage. When the input voltage falls below the recovery voltage, the driver will restart automatically.
Short Circuit Protection	-	-	-	Self-recovery after 4 seconds when the fault condition is removed.
Output Over Voltage Protection	-	-	-	Self-recovery after 4 seconds when the fault condition is removed.
Dimensions (Φ*H)mm	Φ127*H59			
Net Weight	700±50g			
Package (L*W*H)	490*370*169 mm; 10PCS/Ctn., GW:8.2Kg			

## DALI Specifications

Parameter	Min	Typ.	Max	Notes
24V Auxiliary Output Voltage	21V	24V	27V	100-277Vac, P load>0.1W
24V Auxiliary Output Source Current	0mA	-	125mA	Return terminal is "DA-"
24V Auxiliary Output Transient Peak Current @6W	-	-	250mA	250mA peak for a maximum duration of 2.2ms in a 6.0ms period during which time the average should not exceed 125mA.
24V Auxiliary Output Transient Peak Current @10W	-	-	425mA	425mA peak for a maximum duration of 1.3ms in a 5.2ms period during which time the average should not exceed 125mA.
Integrated DALI-2 Bus Power Supply Voltage	12V	16V	20V	Voltage is depending on loading.
Integrated DALI-2 Bus Power Supply Current	50mA	-	60mA	Return terminal is "DA-"
DALI-2 (High Voltage Level)	9.5V	16V	22.5V	
DALI-2 (Lower Voltage Level)	-6.5V	0V	6.5V	Return terminal is "DA-"
DALI-2 (Dimming Output Range)	10% I <sub>set</sub>	-	100% I <sub>set</sub>	I <sub>set</sub> = 0.60-1.10A
DALI-2 (Sink Current)	-	-	2.0mA	

Note: Factory default the bus power is on

## Safety Specifications

Parameter	CE	Note
Dielectric Strength (Input-Ground)	1500Vac	
Grounding Resistance	≤0.1Ω	25°C±10°C Ambient Temperature, pass 25A Current, 60s.
Insulation Resistance	≥10MΩ	Input-PE, 500Vdc/60s/25°C

Notes: The voltage resistance requirement of aluminum substrate is greater than 2KVac.

## Safety Compliance

Safety Category	Safety normative standards	Certification	Notes
CCC	GB19510.1, GB19510.14		
CE	EN61347-1, EN61347-2-13, EN62493	√	
ENEC	EN61347-1, EN61347-2-13, EN62384	√	
CB	IEC61347-1, IEC61347-2-13	√	
BIS	IS 15885(PART 2/SEC 13)		
UL	UL 8750		
CUL	CSA C22.2 No.250.13		
KC	K61347-1, K61347-2-13		
PSE	J61347-1, J61347-2-13		
SAA	AS/NZS IEC 61347.2.13	√	
SAA	AS/NZS 61347.1	√	

## EMC Compliance

EMC Category	Standards	Approved	Notes
CCC	GB/T 17743, GB 17625.1		
CE	EN 55015	√	
CE	EN 61000-3-2, EN 61000-3-3	√	
CE	EN61000-4-2,3,4,5,6,11	√	
CE	EN 61547	√	
KC	K61547		
KC	K00015		
PSE	J55015		
RCM	AS CISPR15	√	
FCC	FCC part 15		
Surge Shock Immunity	ANSI/C82.77-5-2017		
	IEC/EN 61000-4-5		
Ringing Wave	IEC/EN 61000-4-12		
	ANSI/IEEE C62.41.2		

## RoHS

Our products comply with reference to RoHS Directive (EU) 2015/863 amending 2011/65/EU.

### Inrush Current Waveform

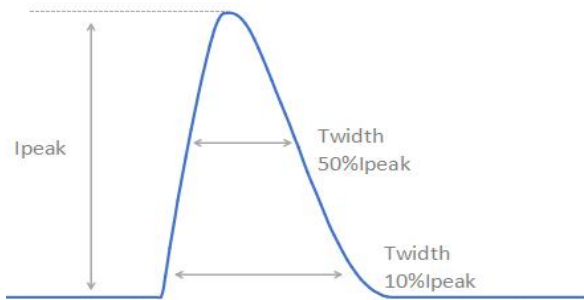

$V_{in}$	$I_{peak}$	$T_{@10\% \text{ of } I_{peak}}$	$T_{@50\% \text{ of } I_{peak}}$
220Vac	43.8A	-	402 $\mu$ s

### Output Voltage vs. Output Current

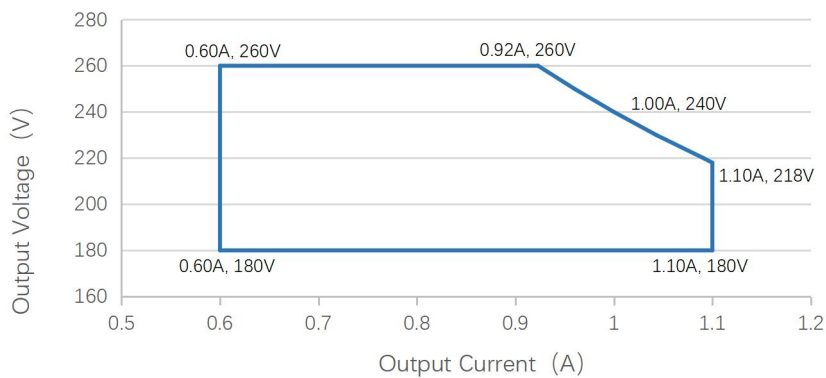

### Output Power vs. Input Voltage

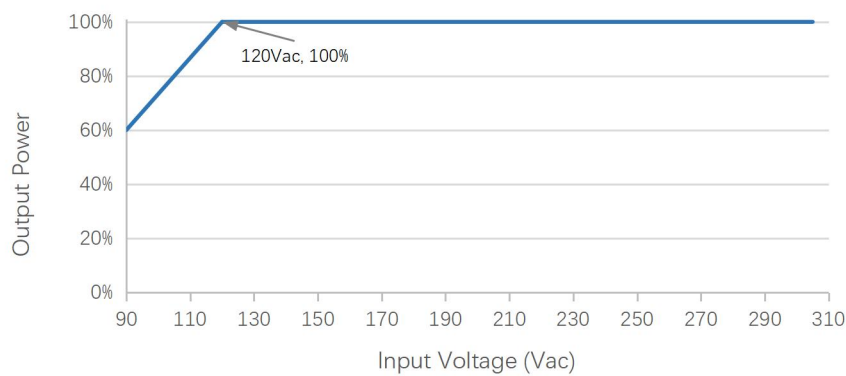

### Efficiency vs. Load

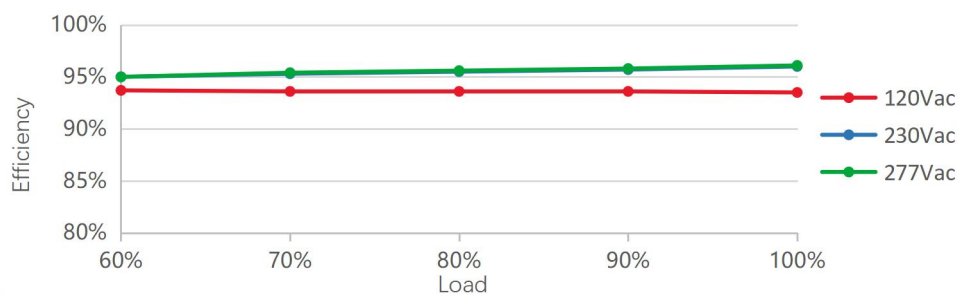

**PF vs. Load**

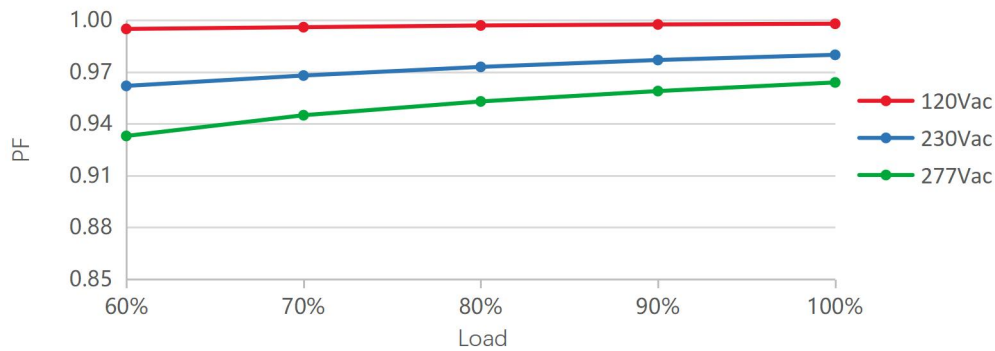

**THD vs. Load**

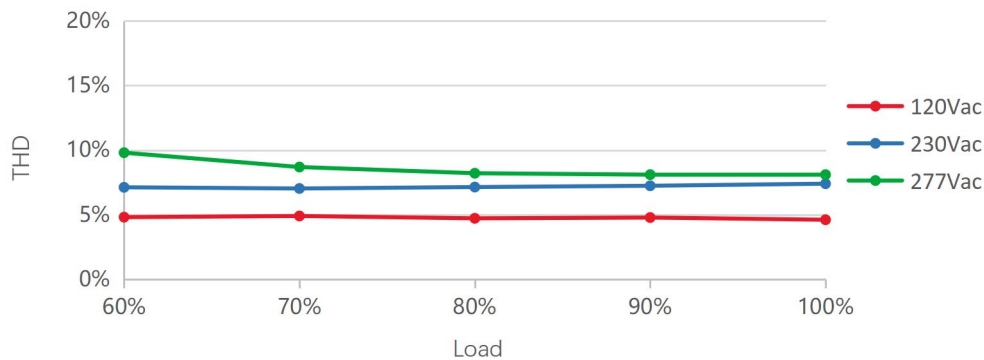

**Output Power vs. Case Temperature**

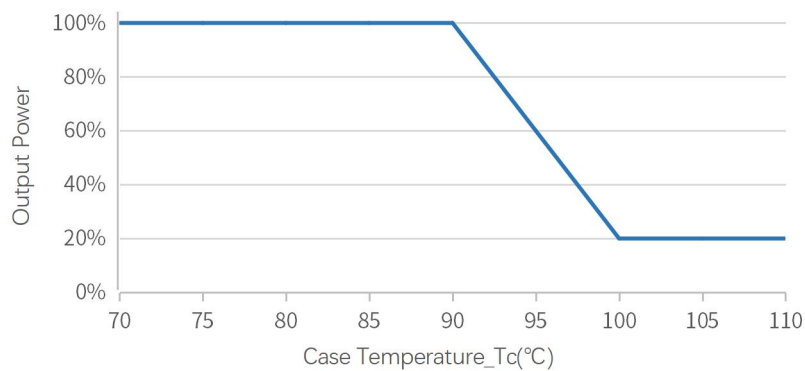

Notes:

The start temperature and end temperature of derating can be set by software. The above curve is the over-temperature protection curve with the default setting. The output will return to normal when the  $T_c$  falls to the normal operating range.

### Lifetime vs. Case Temperature

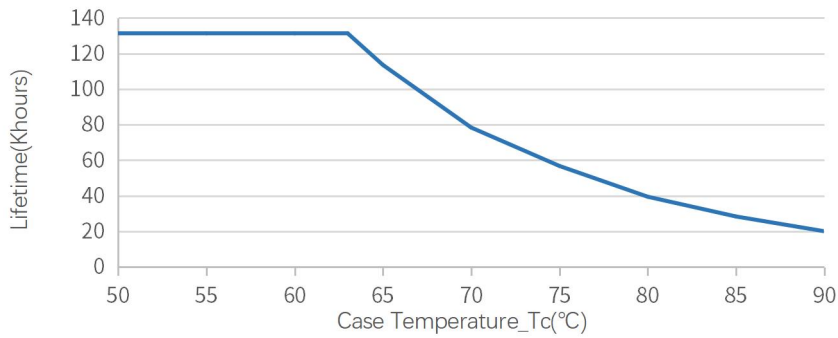

### DALI-2 Dimming

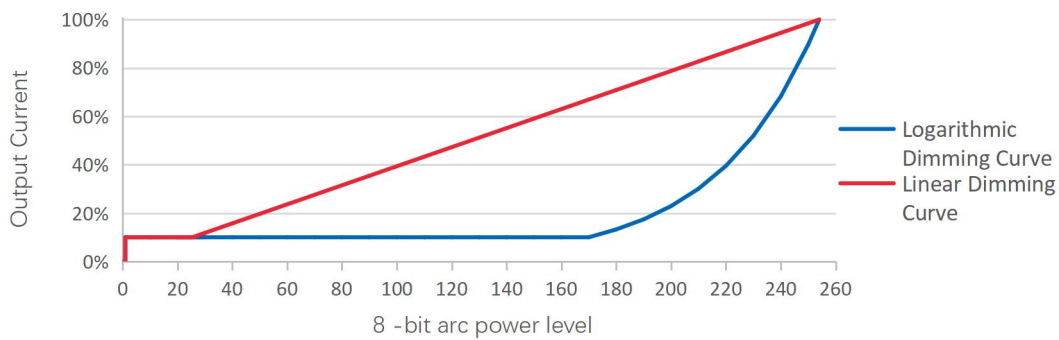

Note: Factory Default Output Logarithmic Curve

### Dip Switch Diagram

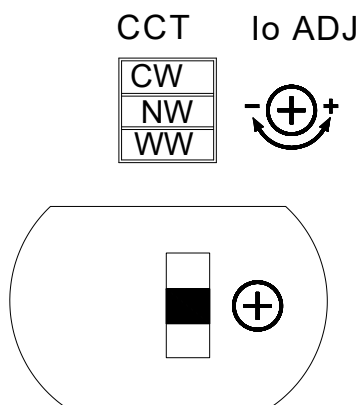

Notes: Using the dip switch when adjusting the color temperature, please operate it after the input is powered off.

---

**Programming Link (DALI-2)**

---

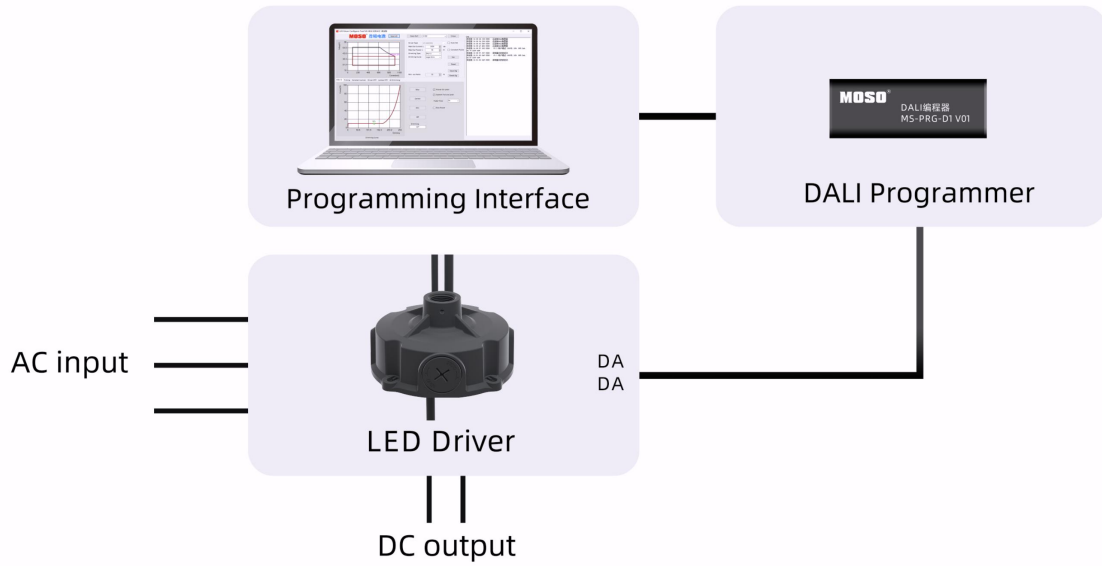

Notes:

1. The driver needs to be powered on during the programming process.
2. Please refer to MS-PRG-D1(Programmer) datasheet for details.

## Time Dimming

Timer dimming has three modes: Timing dimming, Virtual Midnight dimming, Self-Adaptive dimming.

### Timing Dimming

After the driver is powered on, the driver will change in sequence according to the programmed seven periods, and maintain the brightness of timer 7 after running to the last timer.

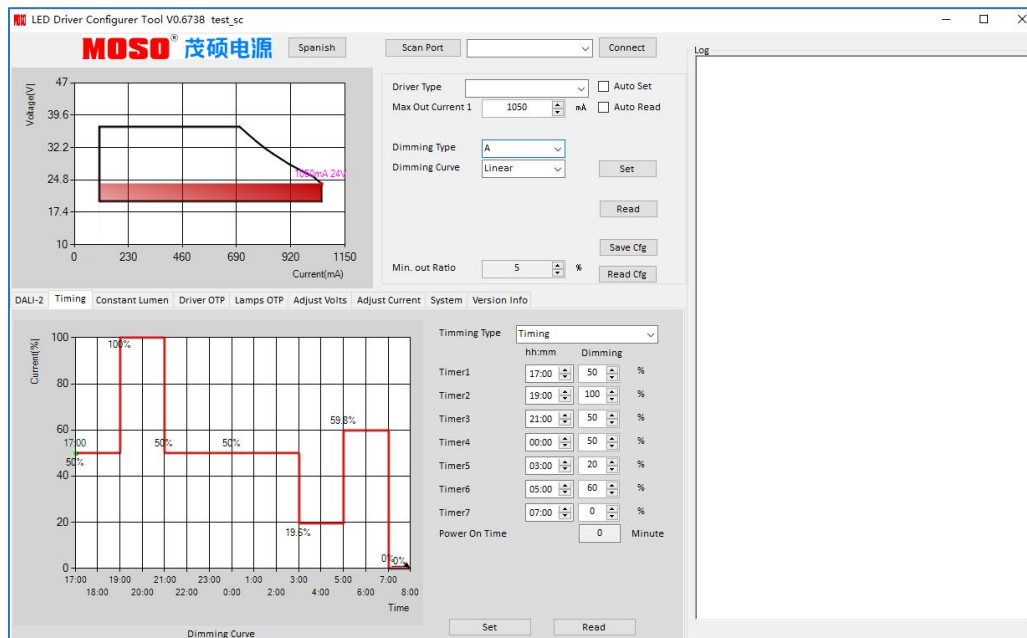

### Virtual Midnight Dimming

The power-on point and power-off point usually correspond to sunset time and sunrise time respectively, so their midpoint is the virtual midnight point. The driver will automatically sample the corresponding effective working days according to the reference days set by the customer, and automatically adjust the dimming curve according to the average working hours.

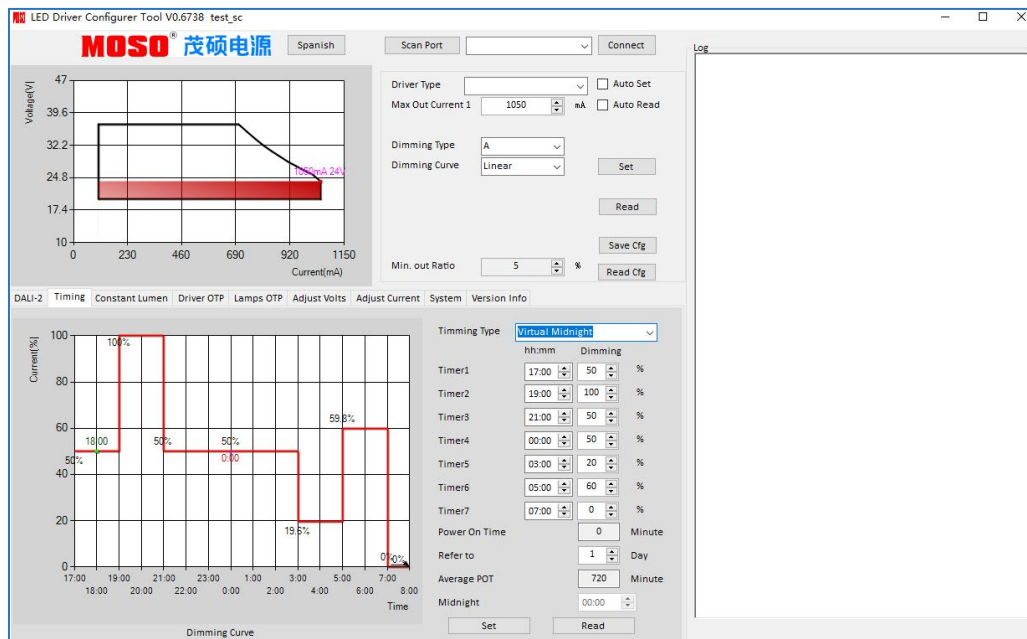

## Mechanical Outline

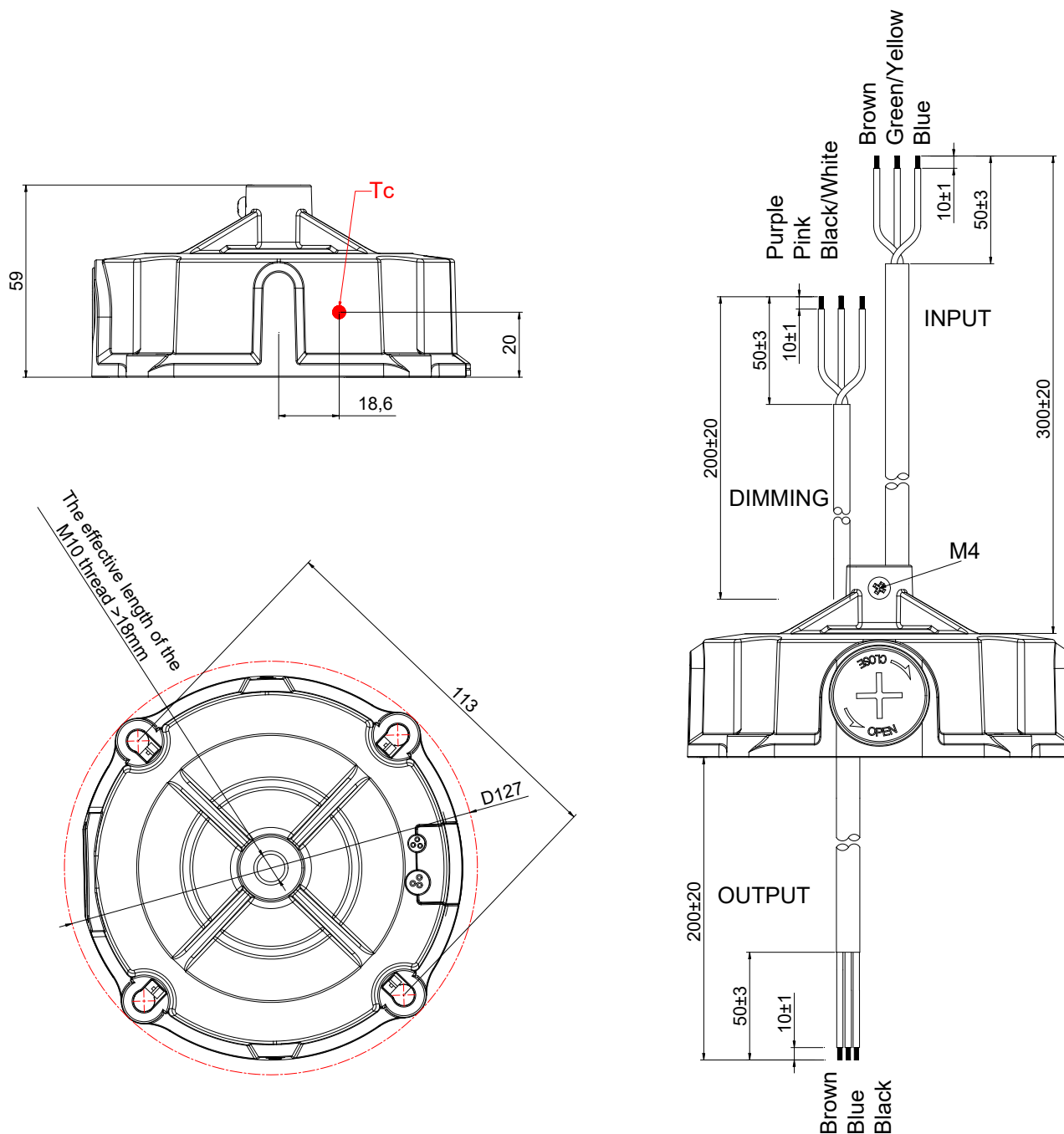

## Specifications

Input	CCC+VDE 3x1.0mm <sup>2</sup> L=300±20mm Strip50±3mm Tinning10±1mm; L : Drown ;N : Blue ; G : Y/G	CCC/CE
Output	CCC+VDE 3x1.0mm <sup>2</sup> L=200±20mm Strip50±3mm Tinning10±1mm; LED+ : Drown ;LED1- : Blue ; LED2- : Black	CCC/CE
Dimming	UL21996 22AWG+3C L=200±20mm Strip50±3mm Tinning10±1mm DA+ : Purple ; DA- : Pink ; 24V : Black/White	UL

Label

<p><b>Input</b></p> <p>L Brown</p> <p>N Blue</p> <p>GY/G</p> <p></p>	<p><b>MOSO</b><sup>®</sup></p>	<p><b>G6-240D260H(II)</b></p> <p>LED Driver, CC mode          Integrated SPD</p> <p>U<sub>out</sub>(No Load): 310V<sup>---</sup></p> <table border="1"> <tr> <td>Input</td> <td>100-277V~ 50/60Hz, 2.8A Max. PF:0.9C.280W</td> </tr> <tr> <td>Output</td> <td>Output voltage:180-260V<sup>---</sup>; I<sub>rated</sub>:0.60-1.10A, Prated:240W Max.</td> </tr> </table> <p>t<sub>c</sub>:90°C t<sub>a</sub>:50°C; Dimming Range 10%-100%</p>	Input	100-277V~ 50/60Hz, 2.8A Max. PF:0.9C.280W	Output	Output voltage:180-260V <sup>---</sup> ; I <sub>rated</sub> :0.60-1.10A, Prated:240W Max.	<p><b>Output</b></p> <p>Brown LED<sup>+</sup>,<sup>+</sup></p> <p>Blue LED1<sup>+</sup>,<sup>-</sup></p> <p>Black LED2<sup>+</sup>,<sup>-</sup></p> <p>Purple DALI<sup>+</sup>,<sup>+</sup></p> <p>Pink DALI/24V<sup>+</sup>,<sup>-</sup></p> <p>Black/White 24V<sup>+</sup>,<sup>+</sup>          (24V 125mA)</p>
Input	100-277V~ 50/60Hz, 2.8A Max. PF:0.9C.280W						
Output	Output voltage:180-260V <sup>---</sup> ; I <sub>rated</sub> :0.60-1.10A, Prated:240W Max.						
<p>         </p> <p>For LED module only      SHENZHEN MOSO ELECTRONICS TECHNOLOGY CO., LTD          MADE IN CHINA      No.1061, Songbai Road, Xili Town, Nanshan District,          Shenzhen, CHINA</p>							