





SPECIFICATION FOR APPROVAL

DESCRIPTION: TRANSFORMER
 SPECIFICATION: EFD25-2.3mH
 PART NO: FWPTEFD25H232K-1
 ISSUE DATE: 18 May 2022

MANUFACTURER APPROVAL		
PREPARED	CHECKED	APPROVED
		

CUSTOMER APPROVAL		
PREPARED	CHECKED	APPROVED

Haining Ferriwo Electronics Co.,Ltd.	
Address:Block 13, Caohejing Technology Park, No.8, Haining Avenue, Haining, Zhejiang 314400, China	
TEL:+86-0573-87088701	FAX:+86-0573-87081130
www.ferriwo.com	sales@ferriwo.com

SPECIFICATION

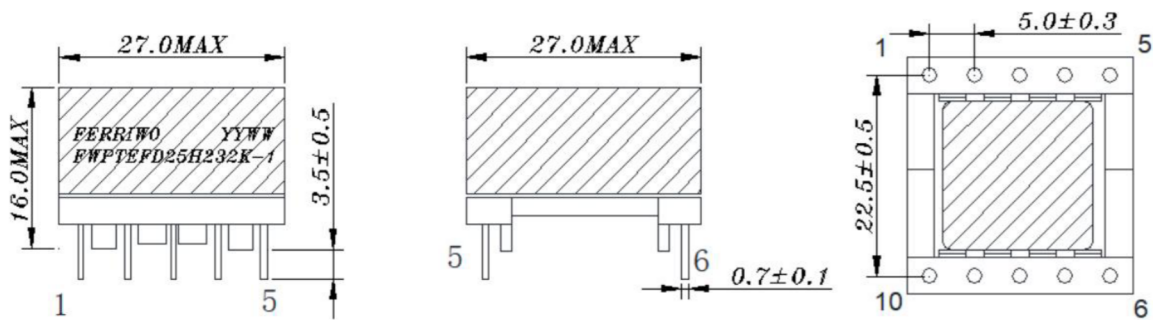

1. PHYSICAL DIMENSION(UNIT: m/m):



LEAD FREE

*.Core fix tape 2Ts .

*.The Label is placed on the product(see the picture above).

DIM	A	B	C	D	E	F	G	H				
SPEC												
						DESCRIPTION		TRANSFORMER				
						Customer P/N		EFD25-2.3mH				
						FERRIWO P/N		FWPTEFD25H232K-1				
SPEC. NO.	PS-2022-020				PREPARED			APPROVED				

SPECIFICATION

2.WINDING TABLE:

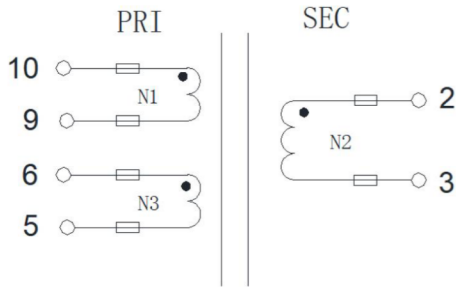

3.WINDING:

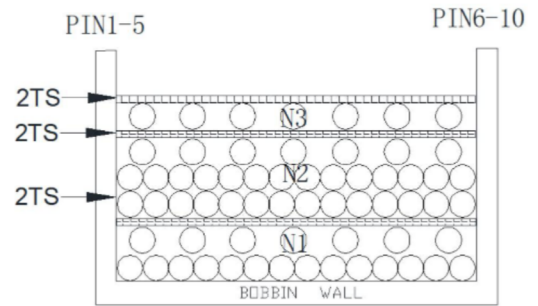

4.WINDING TABLE:

Winding NO.	Margin Tape	PIN	Wire & Wire Copper	Turns	Winding Type	Tape Layer	Tube
N1		10~9	0.35 ϕ x 1P	72Ts	CLOSE+SPREAD	2Ts	S=F \geq 10mm
N2		2~3	0.35 ϕ x 1P	84Ts	CLOSE+SPREAD	2Ts	S=F \geq 10mm
N3		6~5	0.35 ϕ x 1P	10Ts	SPREAD	2Ts	S=F \geq 10mm

NOTE:

- 1. Products should be vacuum impregnation
- *VARNISH RATIO: 1:1
- *VACUUM TIME: 15~20minutes
- *BAKED TEMPERATURE : 120°C \pm 10°C , 1~1.5hours

LEAD FREE

	DESCRIPTION	TRANSFORMER			
	Customer P/N	EFD25-2.3mH			
	FERRIWO P/N	FWPTEFD25H232K-1			
SPEC. NO.	PS-2022-020	PREPARED		APPROVED	

SPECIFICATION

4/5

5. ELECTRONICAL CHARACTERISTIC:

TEST CONDITION : TEMPERATURE AT 25°C
HUMIDITY AT 65 ±5% RH

TEST ITEM	TEST CONDITION	RESULT
INDUCTANCE CH-3250	@15KHz,1V (9~10)	2.3mH±10%
HI-POT TEST CH-9052	@ 2mA 60SEC (AC)	COIL<->COIL<->CORE 1.0 KV;

NOMINAL RATED POWER - 100 VA

LEAD FREE



DESCRIPTION	TRANSFORMER
Customer P/N	EFD25-2.3mH
FERRIWO P/N	FWPTEFD25H232K-1

SPEC. NO.

PS-2022-020

PREPARED



APPROVED



SPECIFICATION

6. MATERIAL LIST :

ITEM		MATERIAL	SUPPLIER OR MANUFACTURER	TEMPRATING
1	CORE EFD25	FW40 OR EQUIVALENT	HAINING FERRIWO ELECTRONICS CO., LTD.	
2	BOBBIN	PHENOLIC OR EQUIVALENT	SUMITOMO BAKELITE CO., LTD. UL NO E41429	150°C
3	WIRE	2UEW-F	PACIFIC ELECTRIC WIRE&CABLE(SHENZHEN) CO. LTD UL NO E84081	155°C
4	TUBE	TEFLON TUBE	GREAT HOLDING INDUSTRIAL CO.,LTD UL NO E156256	200°C
5	TAPE	CT280	YAHUA STICKING TAPE CO.,LTD UL NO E165111	130°C
6	VARNISH	R-1038	JOHN C DOLPH CO BC-346A UL NO E317427	130°C
7	FLUX	TF9100	LINAN GUITONG CHEMICAL TECHNICAL CO.,LTD	
8	TIN	Sn99.3Cu0.7	HAINING ZHUCHANG METAL FOIL CO;LTD	

LEAD FREE



DESCRIPTION	TRANSFORMER
Customer P/N	EFD25-2.3mH
FERRIWO P/N	FWPTEFD25H232K-1

SPEC. NO.

PS-2022-020

PREPARED



APPROVED

