





SPECIFICATION FOR APPROVAL

DESCRIPTION: TRANSFORMER
 SPECIFICATION: RLCx50W-T2
 PART NO: FWPTEFD25H202KL
 ISSUE DATE: 10 January 2023

MANUFACTURER APPROVAL		
PREPARED	CHECKED	APPROVED
		

CUSTOMER APPROVAL		
PREPARED	CHECKED	APPROVED

Haining Ferriwo Electronics Co.,Ltd.	
Address:Block 13, Caohejing Technology Park, No.8, Haining Avenue, Haining, Zhejiang 314400, China	
TEL:+86-0573-87088701	FAX:+86-0573-87081130
www.ferriwo.com	sales@ferriwo.com

SPECIFICATION

1. PHYSICAL DIMENSION(UNIT: m/m):

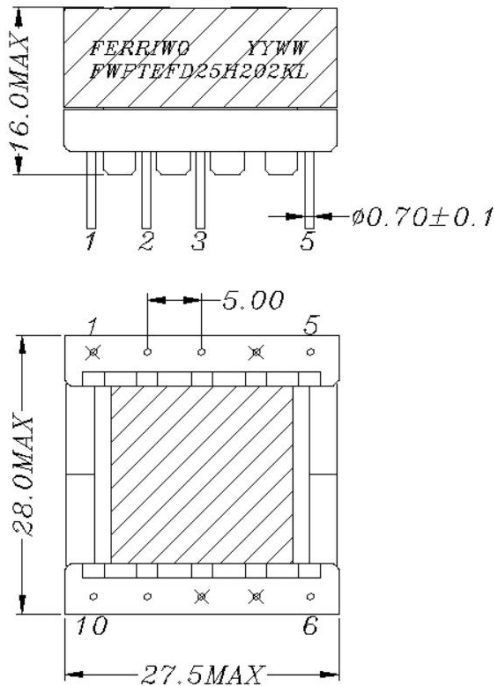



NOTE:
CUT OFF PIN1,4,7,8

LEAD FREE

*.Core fix tape 3Ts .

*.The Label is placed on the product(see the picture above).

DIM	A	B	C	D	E	F	G	H				
SPEC												
FERRIWO						DESCRIPTION			TRANSFORMER			
						Customer P/N			RLCx50W-T2			
						FERRIWO P/N			FWPTEFD25H202KL			
SPEC. NO.	PS-2023-002				PREPARED			APPROVED				

SPECIFICATION

2.WINDING TABLE:

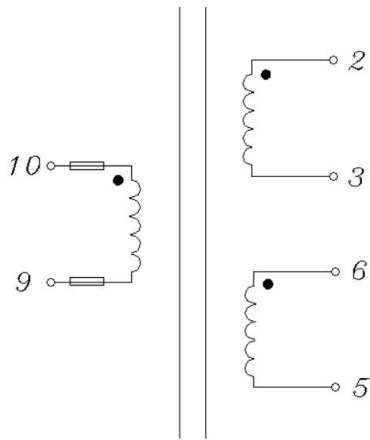

3.WINDING:

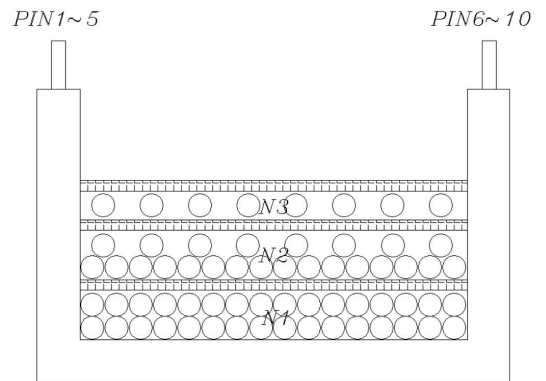

4.WINDING TABLE:

Winding NO.	Margin Tape	PIN	Wire &Wire Copper	Turns	Winding Type	Tape Layer	Tube
N1		10~9	0.4 ϕ x 1P	75Ts	CLOSE	2Ts	S=F≥12mm
N2		2~3	0.4 ϕ x 1P	46Ts	CLOSE	2Ts	
N4		6~5	0.4 ϕ x 1P	8Ts	SPREAD	3Ts	

NOTE:

- 1. Products should be vacuum impregnation
- *VARNISH RATIO: 1:1
- *VACUUM TIME: 15~20minutes
- *BAKED TEMPERATURE : 120°C±10°C, 1~1.5hours

LEAD FREE



DESCRIPTION	TRANSFORMER
Customer P/N	RLCx50W-T2
FERRIWO P/N	FWPTEFD25H202KL

SPEC. NO.	PS-2023-002	PREPARED		APPROVED	
-----------	-------------	----------	--	----------	--

SPECIFICATION

5. ELECTRONICAL CHARACTERISTIC:

TEST CONDITION : TEMPERATURE AT 25°C

HUMIDITY AT 65 ±5% RH

TEST ITEM	TEST CONDITION	RESULT
INDUCTANCE CH-3250	@15KHz,1V (10~9)	2.0mH±10%
DCR CH-502	(10~9)	0.5Ω MAX
DC BIAS TH-1773	@15KHz,1V IDC=0.6A (10~9)	L>80%LOA
HI-POT TEST CH-9052	@ 5mA 60SEC (AC)	N1<->N2 1.5 KV; N1<->N3 1.5 KV; N1<->CORE 1.5 KV;

NOMINAL RATED POWER - 100 VA

LEAD FREE

FERRIWO

DESCRIPTION

TRANSFORMER

Customer P/N

RLCx50W-T2

FERRIWO P/N

FWPTEFD25H202KL

SPEC. NO.

PS-2023-002

PREPARED



APPROVED



SPECIFICATION

6. MATERIAL LIST :

ITEM	MATERIAL	SUPPLIER OR MANUFACTURER	TEMPRATING	
1	CORE EFD26	FW44 OR EQUIVALENT	HAINING FERRIWO ELECTRONICS CO., LTD.	
2	BOBBIN	PHENOLIC OR EQUIVALENT	SUMITOMO BAKELITE CO., LTD. UL NO E41429	150°C
3	WIRE	2UEW-F	PACIFIC ELECTRIC WIRE&CABLE(SHENZHEN) CO. LTD UL NO E84081	155°C
4	TUBE	TEFLON TUBE	GREAT HOLDING INDUSTRIAL CO.,LTD UL NO E156256	200°C
5	TAPE	CT280	YAHUA STICKING TAPE CO.,LTD UL NO E165111	130°C
6	VARNISH	R-1038	JOHN C DOLPH CO BC-346A UL NO E317427	130°C
7	FLUX	TF9100	LINAN GUITONG CHEMICAL TECHNICAL CO.,LTD	
8	TIN	Sn99.3Cu0.7	HAINING ZHUCHANG METAL FOIL CO;LTD	

LEAD FREE



DESCRIPTION

TRANSFORMER

Customer P/N

RLCx50W-T2

FERRIWO P/N

FWPTEFD25H202KL

SPEC. NO.

PS-2023-002

PREPARED



APPROVED

