

CUSTOMER TERMINAL	ROHS	Lead (Pb) -free
	YES	YES

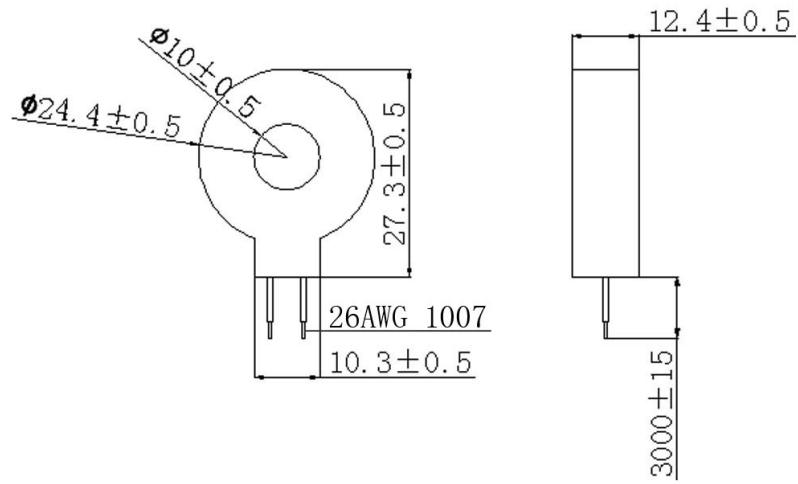

1. Mechanical Dimensions (Unit:mm)



2. Schematic Diagram

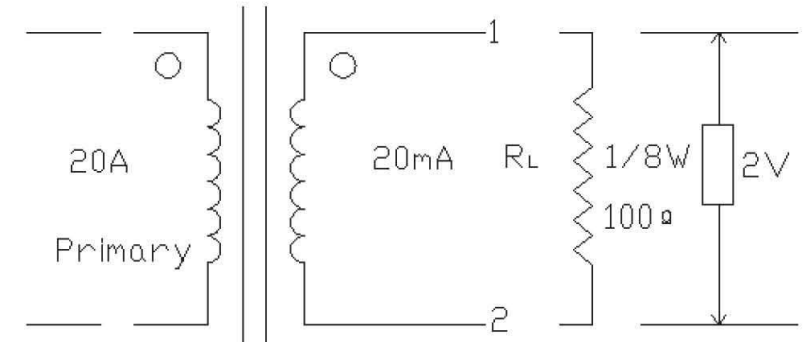

3. Electrical parameters

Pri current A		Sec current mA	Sec voltage V	Load Resistance Ω	DC Resistance Ω	Temperature °C	Humidity 25°C
Basic current	Current max						
20	60	20	2	100	51.8 ref	-55~130	>90%

4. Test Condition

Test Frequency: 50HZ
 Temperature: 25°C
 Humidity: 80~90%
Electrical Requirement:
 Insulation intensity of power frequency: 4KV1min
 Insulation Resistance: ≥600MΩ

REV.	DATE	 Convention Placement	DRW.	Wang Xiao Lin	Drawing Title: CURRENT TRANSFORMER Customer P/N: AC1020	Part No:	FWCST014A/20-3M
0	01/15		CHK.	He Ping		Specification Sheet 1 of 1	
RoHS		www.ferriwo.com	APP.	Wang Yuan Zhi			