

**SPECIFICATION**

1. **General Characteristics**  
0.5mm FPC XXP SMT 90° Easy On Type Bottom Contact H=1.0mm Tape & Reel 5000 PCS/Reel
2. **Material&Finish**  
Insulator:LCP(UL94V-0),Nature  
Cover:LCP(UL94V-0),Black  
Contact:Phosphor Bronze,Gold Flash Over Nickel  
Fitting Nail:Brass,Tin Plated Over Nickel
3. **Electrical Characteristics**  
Current Rating:0.4A DC Max.  
Operation Voltage:50V AC Max.  
Contact Resistance:100 Milliohms Max.  
Insulation Resistance:50 Megaohms Min.  
Withstand Voltage:250V AC RMS For 1 Minute
4. **Environmental Characteristics**  
Operation Temperature:-45°C~+85°C
5. **RoHS Compliant**

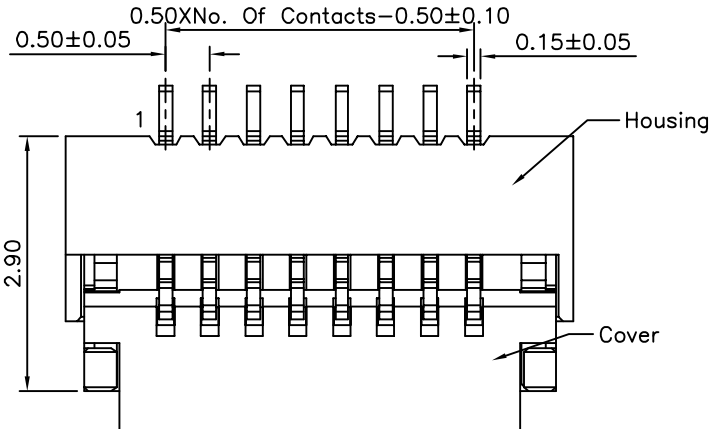

Applicable FPC

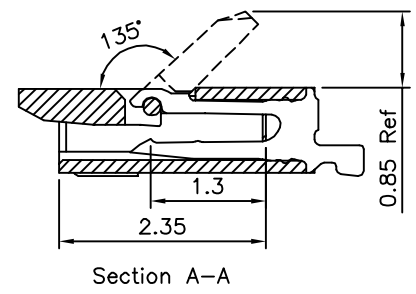

Section A-A

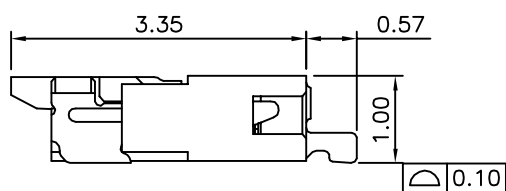
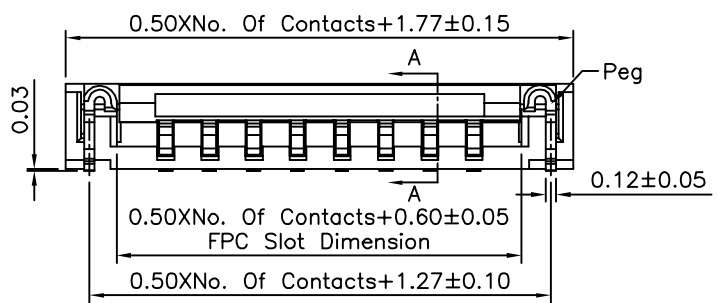

**AUK** A MEMBER OF AUK GROUP  
**太聯事業股份有限公司**  
**AUK CONTRACTORS CO., LTD.**

CATEGORY		APPROVED BY		UNLESS OTHERWISE SPECIFIED TOLERANCES ARE .X ±0.20 X.* ±5* .XX ±0.15 .X.* ±2* .XXX ±0.10 .XX.* ±1*
PART No. FPVXXWHB10-R5K-H		EMILY		
DRAWING No. FPVXXWHB10-R5K-H		CHECKED BY HZF		
SCALE NONE		DRAWING BY CYP		
REV.	A2	UNIT mm		

NO.	REV.	REVISIONS	CHK	DATE
△A2		Modify Data	HZF	11/05/2014
△A1		Modify Data	HZF	04/26/2014
△A0		NEW RELEASE	HZF	01/24/2013

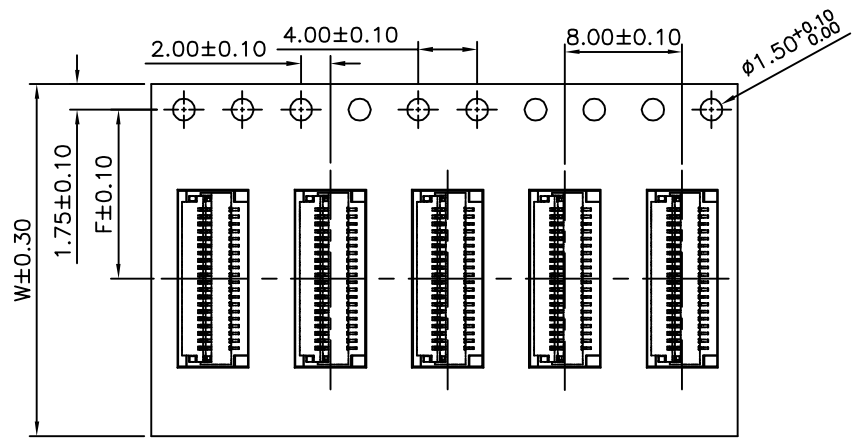

**SPECIFICATION**

Material: Anti-Static Polystyrene, Black  
 Peeling Off Force Of Top Tape: 0.1N~1.0N  
 All Dimensions Meet EIA-481-C Requirements  
 Component Load Per 13" Reel: 5000 PCS  
 RoHS Compliant

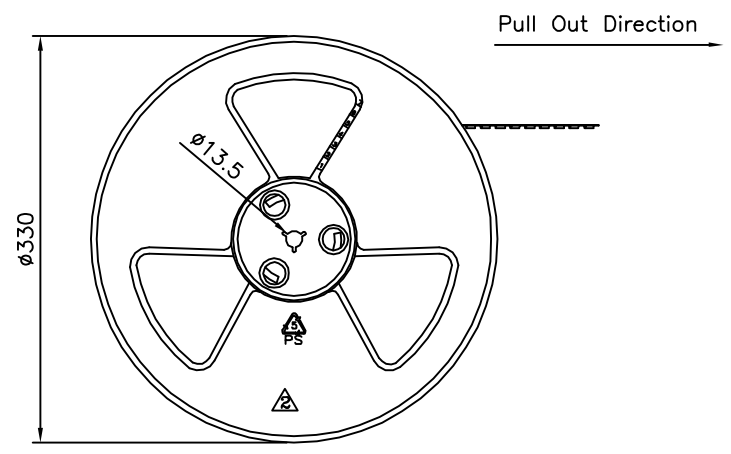
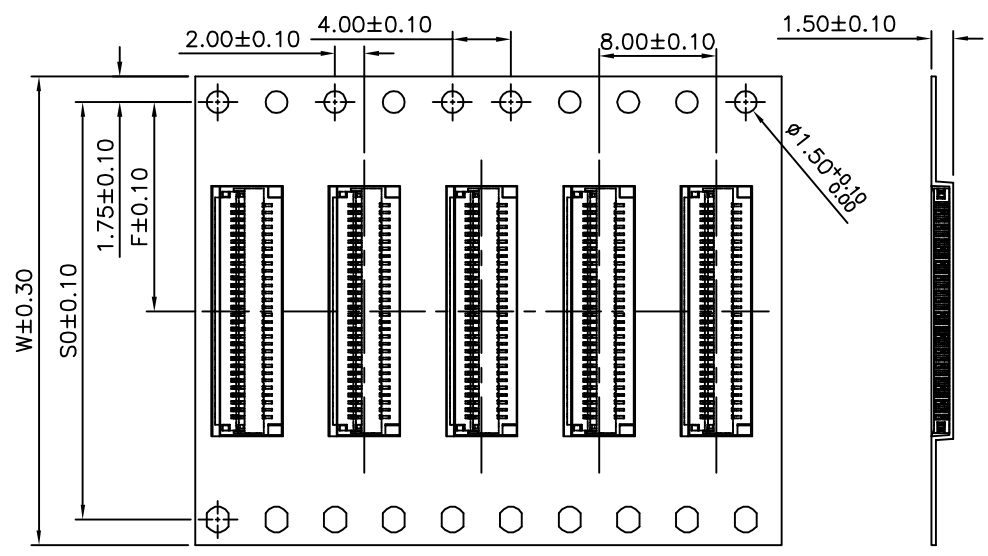
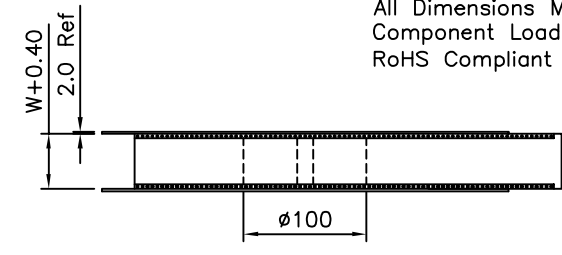

Pin	Reel Width	W	F	S0
06,08	12.4	12	5.5	/
09,10,12	16.4	16	7.5	
16,20,24,26,30	24.4	24	11.5	
32,40	32.4	32	14.2	28.4

**AUK** A MEMBER OF AUK GROUP  
**太聯事業股份有限公司**  
**AUK CONTRACTORS CO., LTD.**

CATEGORY		APPROVED BY		UNLESS OTHERWISE SPECIFIED TOLERANCES ARE .X ±0.20 X.* ±5* .XX ±0.15 .X.* ±2* .XXX ±0.10 .XX* ±1*
PART No. FPVXXWHB10-R5K-H		EMILY		
DRAWING No. FPVXXWHB10-R5K-H		CHECKED BY HZF		
SCALE NONE		DRAWING BY CYP		
REV.	A2	UNIT mm		

NO.	REV.	REVISIONS	CHK	DATE
△A2		Modify Data	HZF	11/05/2014
△A1		Modify Data	HZF	04/26/2014
△A0		NEW RELEASE	HZF	01/24/2013