

NO	DESCRIPTION	MATERIAL	Q'TY	FINISH	REMARK
1	BODY 1	PBT	1	PBT	B-FKR1530-D44
2	BODY 2	BRASS	1	NICKEL	B-FKR1536-N
3	BODY 3	BRASS	1	NICKEL	B-FKR1888-N
4	INSULATION 1	TEFLON	1	TEFLON	I-0698T
5	PIN	PH.BRONZE	1	GOLD	P-FKR1289-G
6	INSULATION 1	TEFLON	1	TEFLON	I-0071T

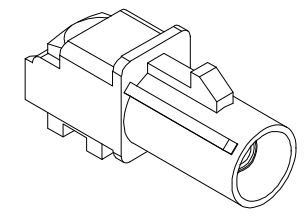
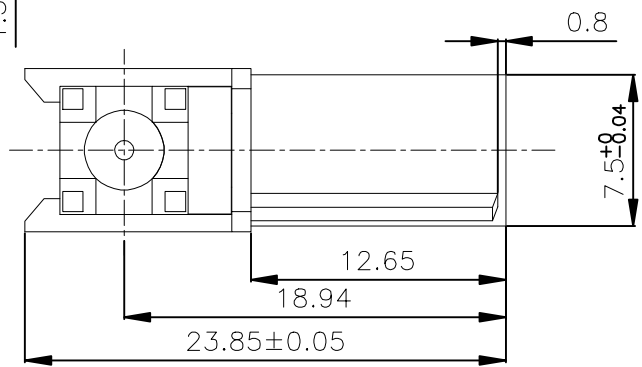
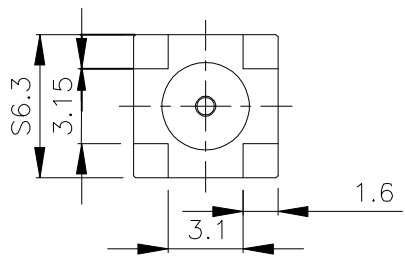
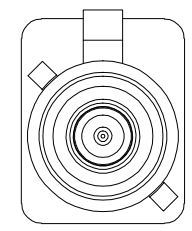
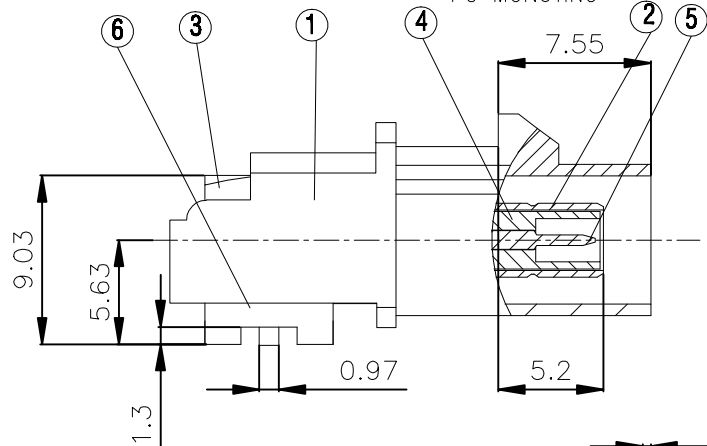
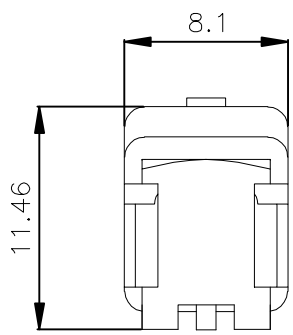
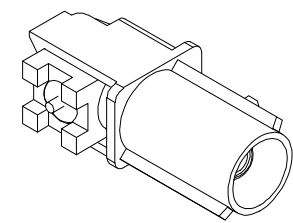
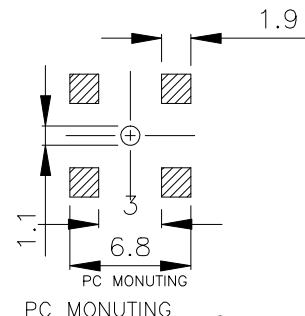

Working Voltage: 49 volts rms max.

	HUS-TSAN GROUP CO., LTD.		DRAWN 林孟翰	DATE 103.02.05	DIMENSIONS ARE IN MILLIMETERS		REVISION	
	P.O.BOX 40-76.TAINAN.TAIWAN,R.O.C.		CHECKED 林孟翰	DATE 103.02.05	UNLESS OTHERWISE SPECIFIED TOLERANCE			
	TITLE FAKRA PLUG PCB MOUNT ORDEAUX-VIOLET/D4004酒紅色		Q.A. 莊千慧	DATE	0.5-5=±0.2	120-315=±1	DESCRIPTION	ENGINEER
	PART NO. FKR-06V5-TGNPD		APPROVAL 徐燦霖	DATE	5-30=±0.4	315-1000=±1.6		
	DRAWING NO. FKR 06V5 TGNPD		REVISION	DATE	30-120=±0.6	1000-2000=±2.4		
				SCALE 4:1	SIZE A			

4

3

2

1