



Classic LCDs & LEDs

LCD MODULE SPECIFICATION

ITEM CODE

FC1602G11-BHAFBW-51SR

SPECIFICATION ESTABLISHED DATE: 2017.04.11



ISSUED BY: 郑林生 CHECKED BY: 李智良 APPROVED BY: 李智良

COPYRIGHT © 2000 ~ 2015 FORDATA ELECTRONIC CO., LTD. ALL RIGHTS RESERVED

INDEX

CONTENTS	PAGE
DATASHEET STATEMENT	1
CODE SYSTEM	2
GENERAL SPECIFICATIONS FEATURES MECHANICAL SPECIFICATIONS ABSOLUTE MAXIMUM RATINGS ELECTRONIC CHARACTERISTICS	3
LCD PANEL CHARACTERISTICS	4
LED BACKLIGHT CHARACTERISTICS	4
LCD MODULE CHARACTERISTICS PIN ASSIGNMENT BLOCK DIAGRAM POWER SUPPLY DIAGRAM	5
FONT MAP	6
MECHANICAL DRAWING	7
PACKING DETAILS	8

AMENDMENT RECORD

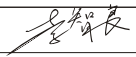
MARK	DATE	DESCRIPTION	ITEM	PAGE	APPROVED
1	2017.04	INITIAL ISSUED	ALL	ALL	



1. The following icons are absolutely designed by FORDATA independently in 2007-SEP. They are unique in the LCD industry and are used for marking out FORDATA products' characteristics quickly and simply without any special meaning. FORDATA reserves the composing right and copyright. No one else is allowed to adopt these icons without FORDATA's approval.
2. The ISO9001 logo used in this document is authorized by SGS (www.sgs.com). FORDATA has already successfully passed the strict and professional ISO9001:2000 Quality Management System Certification and got the certificate. (No.: CN07/00404)
3. The technologies/techniques/crafts which denoted by the following icons are not exclusively owned by FORDATA but also shared by FORDATA's LCD strategic cooperators, however all these technologies/techniques/crafts have been finally confirmed by FORDATA's professional engineers and QC department.
4. As the difference in test standard and test conditions, also FORDATA's insufficient familiarity with the actual LCD using environment, all the referred information in this DATASHEET (including the icons) only have two functions:
 - 4.1: providing quick reference when you are judging whether the product meets your requirements or not.
 - 4.2: listing out the tolerance.

FORDATA declares seriously: you should first test the corresponding sample(s) before signing the formal FORDATA SAMPLE APPROVAL document rather than consider this DATASHEET as the standard for judging whether the LCD meets your requirements or not. Once you place bulk order(s) to FORDATA without testing samples. FORDATA will disclaim all responsibility if the mass-production is proved not to meet with your requirements.
5. The sequence of the icons is random and doesn't indicate the importance grade.

6. Icons explanation



FORDATA is an integrated manufacturer of flat panel display (FPD). All above listed icons and words compses FORDATA's logo.
 From 2000, FORDATA has supplied LCD module
 From 2006, FORDATA has supplied TN, HTN, STN, FSTN monochrome LCD panel
 From 2012, FORDATA has supplied all kinds of LED backlight.



FAST RESPONSE TIME
 This icon on the cover indicates the product is with high response speed; Otherwise not.



PROTECTION CIRCUIT
 This icon on the cover indicates the product is with protection circuit; Otherwise not.



HIGH CONTRAST
 This icon on the cover indicates the product is with high contrast; Otherwise not.



LONG LIFE VERSION
 This icon on the cover indicates the product is long life version (over 9K hours guaranteed); Otherwise not.



WIDE VIEWING SCOPE
 This icon on the cover indicates the product is with wide viewing scope; Otherwise not.



Anti UV VERSION
 This icon on the cover indicates the product is against UV line. Otherwise not.



RoHS COMPLIANCE
 This icon on the cover indicates the product meets ROHS requirements; Otherwise not.



EASY OPERATION TEMPERATURE
 This icon on the cover indicates the product can have good contrast on one driving voltage in indicated operation temperature range.



3TIMES 100% QC EXAMINATION
 This icon on the cover indicates the product has passed FORDATA's thrice 100% QC. Otherwise not.



TWICE SELECTION OF LED MATERIALS
 This icon on the cover indicates the LED has passed FORDATA's twice strict selection which promises the product's identical color and brightness; Otherwise not.



VlcM = 3.0V
 This icon on the cover indicates the product can work at 3.0V exactly; otherwise not.



N SERIES TECHNOLOGY (2008 developed)
 FORDATA adopts new structure, new craft, new technology and new materials inside both LCD module and LCD panel to improve the "RainBow"



1	2	3	4	5	6	—	7	8	9	10	11	12	—	13	14	15	16
F	C	08	01	A	23	—	F	H	Y	Y	B	W	—	5	2	L	E

No.	REMARKS	DESCRIPTION				
1	COMPANY ABBRAVIATION	F = FORDATA				
2	STANDARD MODULE TYPE	C = Character type standard LCD module (COB version) G = Graphic type standard LCD module (COB version)				
3	Character (FC series)	08, 10, 12, 16, 20, 24, 40, = Character number Per line				
	Graphic (FG series)	80, 100, 120, 122, 128, 160 = Row Dots Quantity				
4	Character (FC series)	01, 02, 04, = Character Lines				
	Graphic (FG series)	32, 64, 80, 128, 160 =Column Dots Quantity				
5	Serial Number	A~Z which is decided by the sizes of viewing area				
6	Identifying Code	00~99 which is decided by all the other aspects for the same viewing area				
7	Polarizer type	R = Positive Reflective M = Positive Transmissive B = Super Black technology <i>New!</i> F = Positive Transflective N = Negative Transmissive				
8	Backlight type	N = No Backlight S = Edge Type LED Backlight (Standard version) H = Edge Type LED Backlight (Long life span version) <i>New!</i> E = EL backlight without Invertor C = CCFL backlight without Invertor L = Array Type LED Backlight F = EL backlight with Invertor T = CCFL backlight with Invertor				
9	Backlight color	N = No Backlight R = Red B = Blue Y = Yellow-Green A = Amber G = Green W = White C = Blue-Green Q = RedGreenBlue three color <i>New!</i>				
10	LCD panel type	T = TN G = Gray STN H = HTN B = Blue STN Y = Yellow-Green STN F = FSTN				
11	Viewing angle	B = Bottom 6:00 T = Top 12:00 R = Right 3:00 L = Left 9:00				
12	Operation temperature range	S = 0°C ~ 50°C (Single Supply Voltage) W = -20°C ~ 70°C (Single Supply Voltage) T = -30°C ~ 80°C (Single Supply Voltage) D = 0°C ~ 50°C (Dual Supply Voltage) H = -20°C ~ 70°C (Dual Supply Voltage) E = -30°C ~ 80°C (Dual Supply Voltage)				
13	Driving Voltage Code (This code was updated from 2015-JAN-1ST)		Vlcm = 3.0V	Vlcm = 3.3V	Vlcm = 3.6V	Vlcm = 5.0V
		Vled = Indicated Voltage*	P	R	X	Q
		Vled = 4.2V	M	G	D	K
		Vled = 3.0V	9	A	3	4
		Vled = 3.3V	T	B	K	F
		Vled = 5.0V	8	C	2	5
	NO/EL/CCFL	1	H	7	6	
14	Backlight Connect Method	0 = PIN1 LED-, PIN2 LED+ 1 = PIN15(17/19) LED+, PIN16(18/20) LED- 2 = PIN15(17/19) LED-, PIN16(18/20) LED+ 3 = PIN15(17/19) LED+, PIN16(18/20) NC 4 = PIN15(17/19) NC, PIN16(18/20) LED+ 5 = PINA LED+, PINK LED- 6 = No / EL / CCFL Backlight				
15	IC Manufacturer Code	A~Z or 01~99 which is decided by different IC manufacturers				
*16	Font Set	A~Z or 01~99 which is decided by different font maps				

* Please refer INDICATED VOLTAGE of LED in Page4 and Page5.



FEATURES

AVAILABLE OPTIONS	CHARACTERISTICS	CODE	No.
DISPLAY FORMAT	16 Characters by 2 Lines	FC1602G11	1~6
POLARIZER OPTIONS	Negative Super Black	B	7
BACKLIGHT TYPE OPTIONS	Edge Type LED Backlight (Long life span version)	H	8
BACKLIGHT COLOR OPTIONS	Amber color	A	9
LCD PANEL OPTIONS	FSTN	F	10
VIEWING ANGLE OPTIONS	6:00 (Bottom)	B	11
TEMPERATURE RANGE OPTIONS	-20°C ~ 70°C, Single Supply Voltage	W	12
SUGGESTED DRIVING VOLTAGE	V _{lcm} = 5.0V V _{led} = 5.0V	5	13
SUGGESTED LED DRIVING MODE	PIN15: LED+, PIN16: LED-	1	14
CONTROLLER ▲1	ST7066U + ST7065C	S	15
FONT MAP CODE	R Version	R	16
DRIVING DUTY	1/16	—	—
DRIVING BIAS	1/5	—	—

▲1 Please ask for datasheet of the mentioned controller from FORDATA or FORDATA's authorized distributors. You can find the related information including AC & DC characteristics, Write & Read Timing diagram, Instruction table and descriptions, DDRAM & CGRAM, Rest Function and so on from the datasheet of controller.

▲1 You can ask for the example of software program (C language) from FORDATA or FORDATA's authorized distributors.

MECHANICAL SPECIFICATIONS

OVERALL SIZE	80.0W x 36.0H	mm	THICKNESS	max 13.5	mm
VIEWING AREA	64.5W x 16.4H	mm	HOLE-HOLE	75.0W x 31.0H	mm
CHARACTER SIZE	3.00W x 5.23H	mm	CHARACTER PITCH	0.51W x 0.52H	mm
DOT SIZE	0.56W x 0.61H	mm	DOT PITCH	0.05W x 0.05H	mm

ABSOLUTE MAXIMUM RATINGS

ITEM	SYMBOL	CONDITION	MIN	TYP	MAX	UNIT
POWER SUPPLY (LOGIC)	V _{dd}	25°C	-0.3	—	7.0	V
POWER SUPPLY (LCD)	V ₀	25°C	V _{dd} -13.5	—	V _{dd} +0.3	V
INPUT VOLTAGE	V _{in}	25°C	-0.3	—	V _{dd} +0.3	V
OPERATING TEMPERATURE	V _{opr}	—	-20	—	70	°C
STORAGE TEMPERATURE	V _{stg}	—	-30	—	80	°C

ELECTRONIC CHARACTERISTICS *

ICONS	ITEM	SYMBOL	CONDITION	MIN	TYP	MAX	UNIT
	INPUT VOLTAGE	V _{lcm} = V _{dd}	—	—	5.0	—	V
	SUPPLY CURRENT	I _{dd}	V _{dd} =5V	—	1.5	—	mA
	DRIVING VOLTAGE FOR LCD PANEL	V _{lcd} = (V _{dd} - V ₀)	-20°C	4.70	—	5.10	V
			0°C	—	—	—	
			25°C	4.30	—	4.80	
			50°C	—	—	—	
			70°C	4.30	—	4.80	

* All data are recorded from TEST REPORT #FSYP000700040



LCD CHARACTERISTICS

FOR STN/FSTN TYPE LCD Panel (TA=25 °C, Vlcd=5.0V ± 0.5V)

ICONS	ITEM	SYMBOL	CONDITION	MIN	TYP	MAX	UNIT
	VIEWING ANGLE	$\Phi 2 - \Phi 1$	K=4	40	—	—	deg
		θ		60			
	CONTRAST RATIO	K	—	6	—	—	—
	RESPONSE TIME(RISE)	TR	—	—	150	250	ms
	RESPONSE TIME(FALL)	TF	—	—	150	250	ms

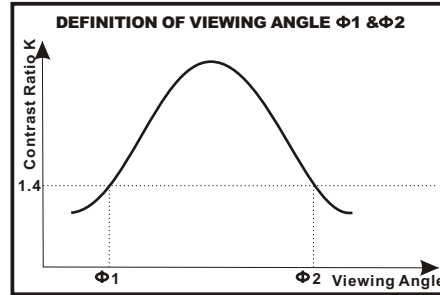
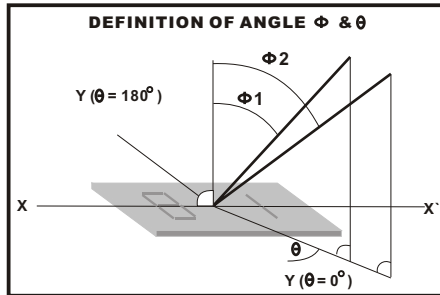

LED CHARACTERISTICS

ICONS	ITEM	SYMBOL	CONDITION	MIN	TYP	MAX	UNIT
	LED FORWARD VOLTAGE	Vf	25°C	—	3.0	—	V
	LED FORWARD CURRENT ▲2	If	25°C	—	17	—	mA
	LED REVERSE CURRENT	Ir	25°C Vr=5.0V	—	—	30	μA
	LED PEAK WAVE LENGTH	λp	25°C If = 17mA	584	—	595	nm
	LED BRIGHTNESS (WITHOUT LCD)	Lv	25°C If = 17mA	—	48	—	cd/m ²
	LED BRIGHTNESS UNIFORMITY	Lvmin/Lvmax	25°C If = 17mA	70	—	—	Ratio
	LED LIFE TIME	—	—	25°C If = 17mA	20K	—	—

▲2 请注意, 驱动背光考虑的是恒流而不是恒压. 所以, 这个数值非常重要!

YOUR ATTENTION: It is constant current (not constant voltage) that should be applied when driving LED backlight. Therefore, this data is very important!

* 当工作温度高于25°C时, Ifm, Ifp和Pd必须降低; 电流降低率是 -0.36*3mA/°C (直流驱动), 或-0.86*3 mA/°C (脉冲驱动), 功率降低率是-75*3mW/°C. 产品工作电流不能大于对应的工作条件温度Ifm或Ifpr的60%.
 For operation above 25°C, The Ifm Ifp & Pd must be derated, the Current derating is -0.36*3mA/°C for DC drive and -0.86*3 mA/°C for Pulse drive, the power dissipation is -75*3 mW/°C The product working current must not be more than 60% of the Ifm or Ifp according to the working temperature.



PIN ASSIGNMENT

PIN	SYMBOL	DESCRIPTION	REMARKS
1	Vss	GND	
2	Vdd	Power supply for LCM	5.0V
3	V0	Contrast Adjust	
4	RS	Register Select Signal	
5	R/W	Data Read / Write	
6	E	Enable Signal	
7	DB0	Data bus line	
8	DB1	Data bus line	
9	DB2	Data bus line	
10	DB3	Data bus line	
11	DB4	Data bus line	
12	DB5	Data bus line	
13	DB6	Data bus line	
14	DB7	Data bus line	
15	LED+	Power supply for BKL	5.0V
16	LED-	Power supply for BKL	

BLOCK DIAGRAM

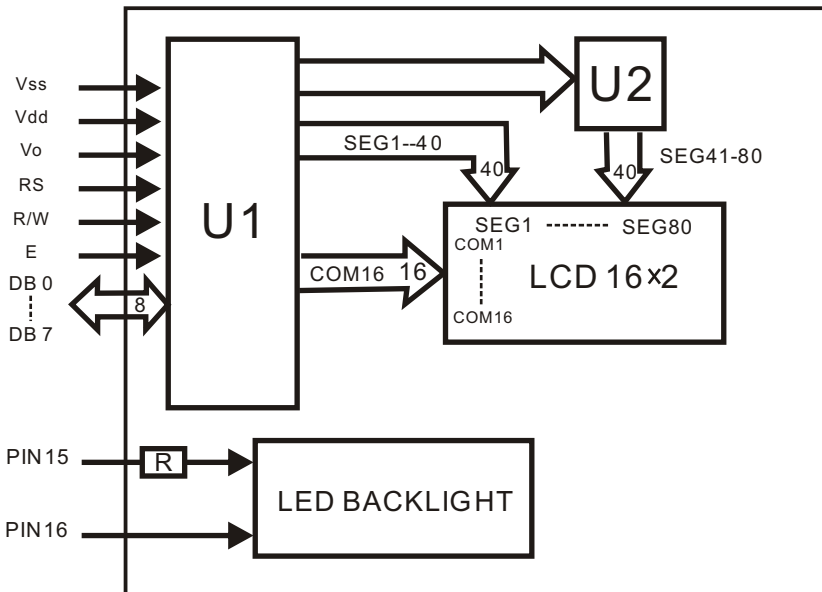

POWER SUPPLY DIAGRAM

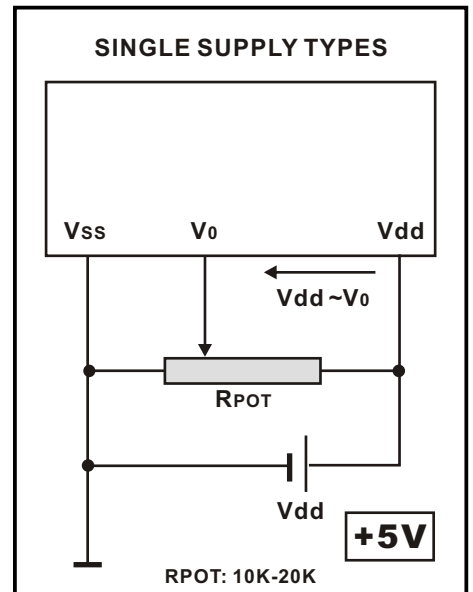

Upper 4bit Lower 4bit	LLLL	LLLH	LLHL	LLHH	LHLL	LHLH	LHHL	LHHH	HLLL	HLLH	HLHL	HLHH	HHLL	HHLH	HHHL	HHHH
LLLL	CG RAM (1)															
LLLH	(2)															
LLHL	(3)															
LLHH	(4)															
LHLL	(5)															
LHLH	(6)															
LHHL	(7)															
LHHH	(8)															
HLLL	(1)															
HLLH	(2)															
HLHL	(3)															
HLHH	(4)															
HHLL	(5)															
HHLH	(6)															
HHHL	(7)															
HHHH	(8)															



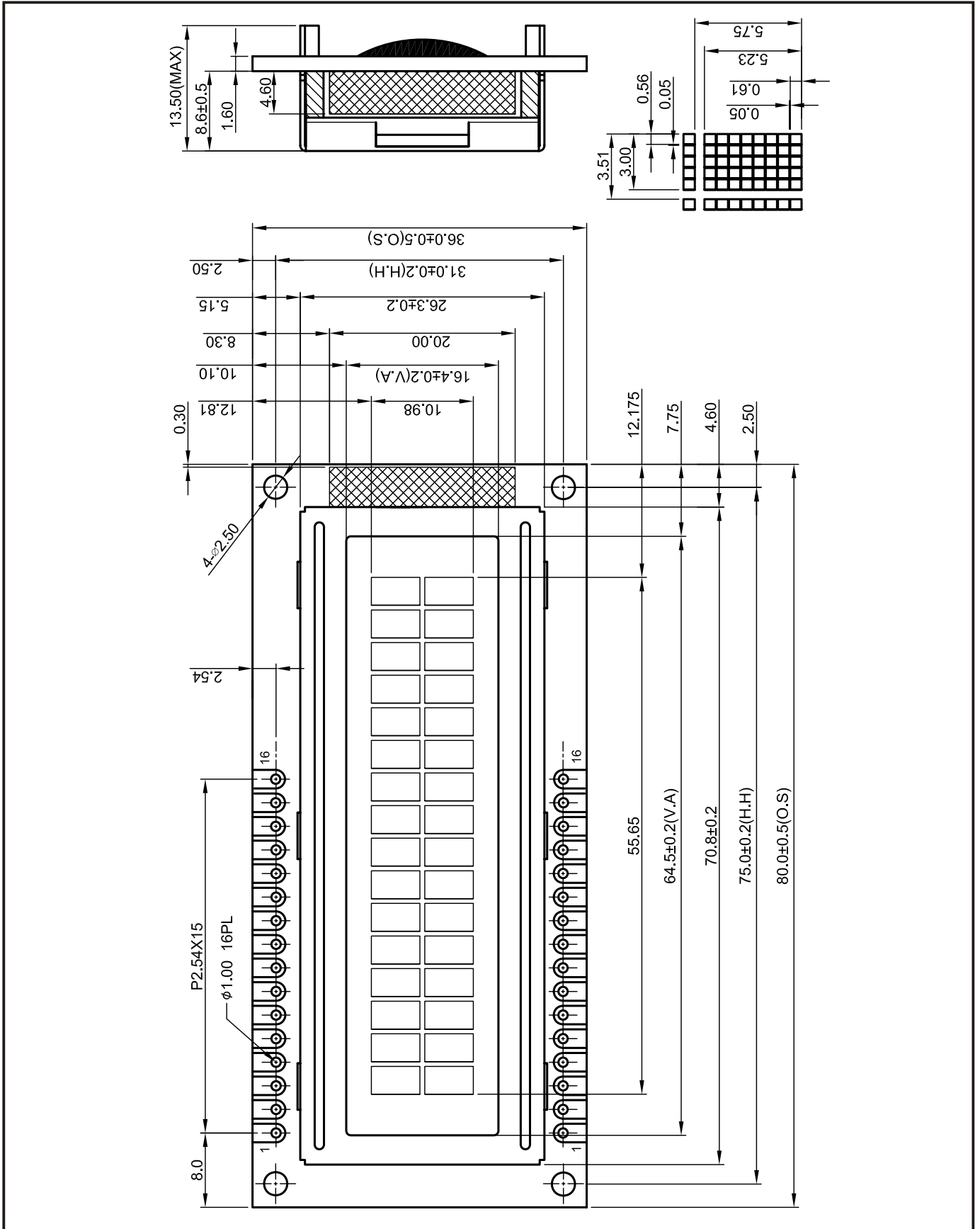

FULL-SIZED PACKAGE
45 PCS/BOX
10 BOXES/CARTON
450 PCS/CARTON
13.00 KGS/CTN(G.W.)
0.054 M ³ /CARTON

HALF-SIZED PACKAGE
45 PCS/BOX
5 BOXES/CARTON
225 PCS/CARTON
6.00 KGS/CTN(G.W.)
0.027 M ³ /CARTON

PACKING DECLARATION
1. This packaging information is for reference only. The actual information is subject to the actual packaging. Especially for packaging of LCL, tolerances may exist.
2. FORDATA will not be responsible for quality problems caused by unnormal transportation conditions (including but not limited to climate factors or human factors, such as improper handling).

