

FEATURES

- ✓ Constant Power design, off-line programmable;
- ✓ 4 in 1 dimming: 0(1)-10V dimming, PWM, RX, Timer dimming;
- ✓ Dim-to-Off;
- ✓ Surge protection: DM: 6KV, CM: 10KV;
- ✓ Multi-Protections: SCP/OVP/OTP/OLP ;
- ✓ 12V/200mA auxiliary power optional;
- ✓ IP67;
- ✓ 5 years warranty.
- ✓ EAC version with Input 380Vac OVP

INTRODUCTION

F1E-200 series is 200W current adjustable LED intelligent LED driver, Its input voltage range is 90-305Vac (180-305Vac @ Full power output), with high efficiency, high power factor, high surge protection and other performance indicators. This series of products have strong compatibility, the output parameters can be offline programmable. The integrated housing meets the protection requirements of IP67 which is suitable for harsh outdoor application environment. High power density and compact size design. Multiple protection designed which including surge protection, over voltage protection, short circuit protection and over temperature protection to ensure the barrier-free operation of this product.

F1E series can be used in LED street lights, tunnel lights, shoebox lights, industrial high bay lights, horticulture lights and landscape lighting applications.

KEY PARAMETERS

Model ^[1]	Max. Power (W)	Working mode	V.out (Vdc)	I.out Adjustable range(A)	I.out Full Power range(A)	Default Output Current (A/Vdc)	Typ. Efficiency ^[2]	Typ. PF
F1E-200X-056YYY	200	C.C	27-54	2.80-5.60	3.70-5.60	4.16/48	93%	0.97
F1E-200X-143YYY	200	C.C	72-143	1.00-2.20	1.40-2.10	1.40/143	94%	0.97
F1E-200X-286YYY	200	C.C	140-286	0.60-1.10	0.70-1.05	0.70/286	94%	0.97

NOTES:

[1] X=N, V, B or D, N=Non-dimming function, B=3-in-1 dimming function, V=I.out adjustable potentiometer, D=DALI. YYY=A12 means 12V/0.2A Auxiliary power.

[2] Unless specify noted, all performance parameters are typically measured at 25 ° c, 230Vac input, full load.

TECHNICAL DATA

Input Characteristics	
Rated Input Voltage	100-240Vac (277Vac for North America only)
Input Voltage Range	90-305Vac (180-305Vac @ Full power output, 90-180Vac @ Derating)
Input Frequency	47~63Hz
Input Current (Typ.)	2.30A @100-277Vac, 100% load
Standby Power Consumption	2.0W Max. @230Vac Dimming shutdown
Inrush Current	75A Max.@ 230Vac, 25°C cold start
Power Factor (Typ.)	PF>0.95 @ 230Vac, 100% load



Total Harmonic Distortion (Typ.)	10% @ 230Vac, 100% load
Output Characteristics	
Current Accuracy	± 5%
Efficiency	94% @230Vac & full load (typ. value)
Output Voltage	Refer to "KEY PARAMETERS"
No Load Output Voltage F1E-200X-056YYY F1E-200X-143YYY F1E-200X-286YYY	60Vdc Max. 155Vdc Max. 310Vdc Max.
Ripple Current	<5%
Line Regulation	3%
Load Regulation	3%
Turn-On Delay Time	1.0S Max.
Timer Dimming	Maximum 7 periods can be set, 10-100% dimming, see "Timer dimming" for detail.
Programmable Current Output Range	The range of nominal current can be adjusted by controller programming; The total output power exceeds the Max. power (actual output voltage * actual output current=power), which cannot be covered by the warranty.
Protective Function	
Input Over Voltage Protection	When the AC input voltage exceeds 330V, it will stop working, and the voltage will automatically recover when the voltage drops below 305V (optional function)
Output Over Voltage Protection	When the product exceeds the limit range, it enters the protected state. After the fault is removed, the product will resume working state.
Dimming Over Voltage Protection	When the dimming wires is wrongly connected to 230Vac, the product enters the protection state. When the fault is eliminated or the machine is restarted, the power supply returns to normal operation (optional function)
Open Circuit Protection	When the LED is open-circuited, the product will enter the protection state, such as burping or clamping at the highest output voltage state, and the product will not be damaged. When the fault is eliminated or the power is restarted, the power supply will return to normal operation.
Short Circuit Protection	When the output is short-circuited, the input power will be reduced accordingly. After the short-circuit condition is removed, the power supply will automatically return to normal.
Over Temperature Protection	Drop current mode. When the over temperature is removed, the current will automatically resume.
Environmental Conditions	
Operating Temperature	-40℃ ~ +50℃ (Ta)
Operating Case Temperature for Safety Tc	+90℃
Humidity	10% - 90% RH, (not condensed)
Storage Temperature	-40℃ ~ +85℃
Storage Humidity	10% - 90%RH, Non-condensing (sea level to 2000 meters)
Vibration	10 - 500Hz X, Y, Z vertical axes vibrate at a constant acceleration of 1.0G (depth 3.5mm) for 1 hour
Degree Of Protection	IP67



Reliability	
Life time	50000Hrs @Tc 75℃, 230Vac, See Life Cycle and Tc Curves for details
MTBF	≥ 200000Hrs@ Ta 25℃, 230Vac, 80% load. (MIL-HDBK-217F)
Warranty	5 years (Tc: 75℃)
Others	
Size	L180*W62*H36mm
Weight	690 ± 50 g
Package	L420mm*W270mm*H195mm 20PCS/Ctn, Gross Weight: 14.4Kg ± 10%
NOTES	
<p>1. It is recommended that customers install over-voltage protection and surge protection devices in the power supply circuit of lamps to ensure the safety of electricity use.</p> <p>2. The power supply is used as a component of the whole lamp in combination with the terminal equipment. Because the EMC performance is affected by the LED lamps and wiring, the terminal equipment manufacturing, The manufacturer needs to re-confirm the EMC of the whole device.</p> <p>3. Please use a special programmer to adjust the current of the power supply, and program and write through the dimming light.</p> <p>4. When adjusting the output current of the power supply, please ensure that the total output power does not exceed the rated maximum power.</p> <p>5. Unless otherwise specified, the above parameters are the test results under the conditions of ambient temperature 25℃, humidity 50%, 100% load, and input voltage 230Vac.</p>	

DIMMING FEATURES

Dimming type	Parameter	Min.	Typ.	Max.	Remark
0-10V(5V) ^[3] Positive logic	Signal level	0V	-	10V(5V)	Max Voltage no more than 12Vdc (6Vdc)
	Dimming range	10%	-	100%	Percentage of Output current programmed
	Shutdown level	0.7V	0.8V	0.9V	
	Turn on level	0.9V	1.1V	1.35V	
10V(5V)-0 Negative logic	Signal level	10V(5V)	-	0V	Max Voltage no more than 12Vdc (6Vdc)
	Dimming range	10%	-	100%	Percentage of Output current
	Shutdown level	-	-	-	
	Turn on level	0.9V	1.1V	1.35V	
PWM	High level	9.7V	-	10.3V	
	Low level	0V	-	0.3V	
	Frequency	200Hz	1KHz	2KHz	
	Duty cycle	5%	-	100%	Positive logic dimming
100%		-	5%	Negative logic dimming	
Dimming resistor	Resistance	10kΩ	-	100kΩ	
	Dimming range	10%	-	100%	Positive logic dimming

Note [3] : The signal amplitude is set to 10V by default, or 5V as required.



SAFETY CRITERION

Safety Category	Country / Territory	Criterion	Approved
CCC	China	GB19510.1, GB19510.14	√
CE	Europe	EN61347-1, EN61347-2-13	√
		EN62493	√
		EN62384	√
CB	CB countries	IEC61347-1, IEC61347-2-13, IEC62493	√
EAC	Russia	IEC61347-1, IEC61347-2-1,	
BIS	India	IS 15885(PART 2/SEC 13)	
UL	USA	UL 8750, UL1310,UL1012	√
cUL	Canada&USA	CSA C22.2 No.250.13	√
KC	Korea	K61347-1, K61347-2-13	
PSE	Japan	J61347-1, J61347-2-13	
SAA	Australia	AS/NZS IEC 61347.2.13	√
		AS/NZS 61347.1	√
DALI-2	Globe countries	IEC62386-101, IEC63286-102, IEC63286-207	

EMC Compliance

EMC Category	Country / Territory	Criterion	Approved
CCC	China	GB/T 17743, GB 17625.1	√
CE	Europe	EN 55015	√
		EN 61000-3-2, EN 61000-3-3	√
		EN61000-4-2,3,4,5,6,11	√
		EN 61547	√
EAC	Russia	IEC 61354,IEC61000-3-2, IEC61000-3-3	
KC	Korea	K61547	
		K00015	
PSE	Japan	J55015	
FCC	USA	FCC part 15	

SAFETY KEY TEST ITEMS

Insulation Requirement	UL	ENEC	CCC	REMARK
Input-Output	1600Vac	3000Vac	3750Vac	Reinforced insulation
Input-Case	1600Vac	1500Vac	1875Vac	Basic insulation
Input-Dim	1600Vac	3000Vac	3750Vac	Reinforced insulation
Output-Dim	1600Vac	1000Vac	1000Vac	Basic insulation
Output-Case	500Vac	1000Vac	1000Vac	Basic insulation
Dim-Case	500Vac	250Vac	500Vac	Basic insulation
OTHERS	Criterion			REMARK
Insulation Resistance	≥10MΩ			Input-Output, Test Voltage:500Vdc
Ground Resistance	≤0.1Ω			25A/1min
Leakage Current	≤0.75mA			240Vac



NOTES:

1. The LED Driver itself meets with EMC standard. However, LED Driver's EMC should be re-checked when integrated into lighting systems due to unexpected interference as component.
2. Please short L and N, LED+ and LED-, Dim+ and Dim - when Hi-pot test.
3. The CCC withstand voltage test needs to disconnect the built-in lightning protection tube. According to the IEC 60598-1:14 standard section 10.2, the "built-in lightning protection tube" can be marked on the nameplate to disconnect the discharge tube on testing.

WORKING CURVE

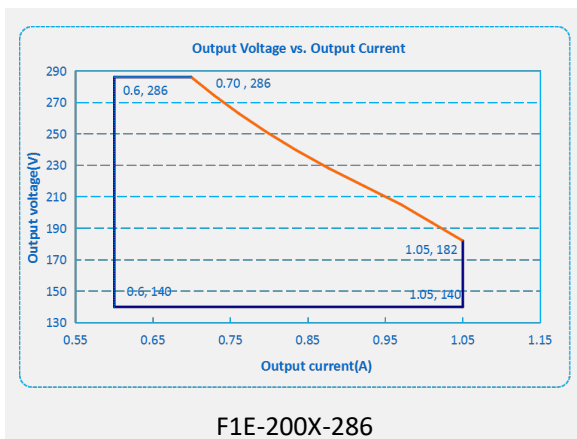
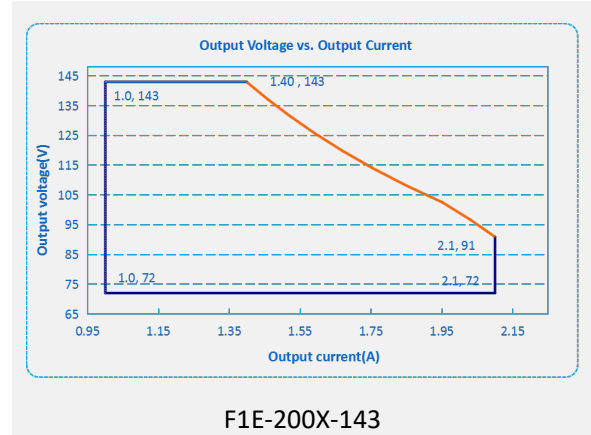
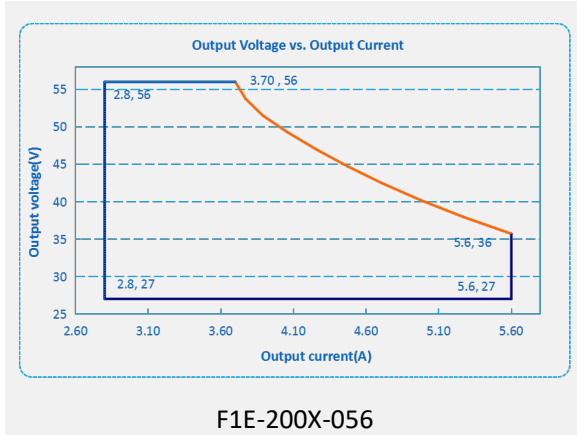

EFFICIENCY VS. LOAD

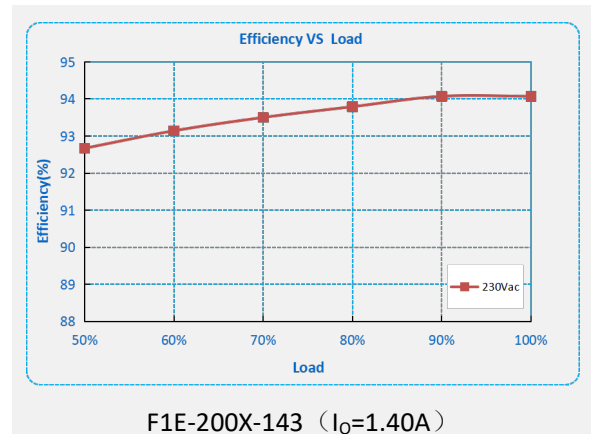
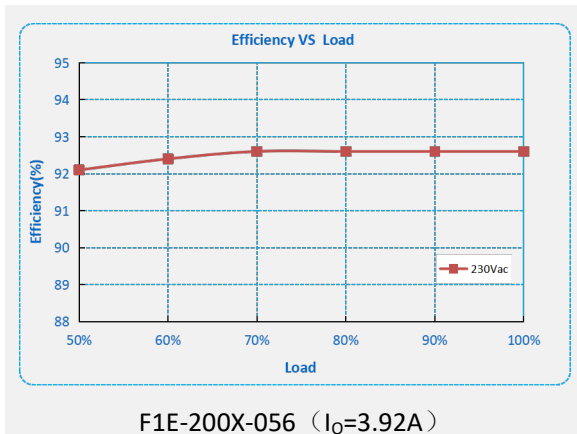

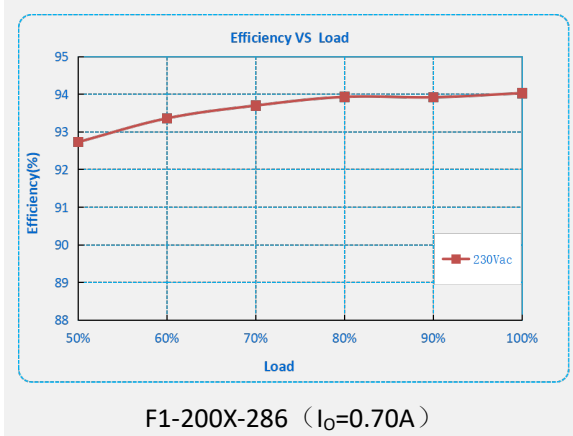

PF VS LOAD CURVE

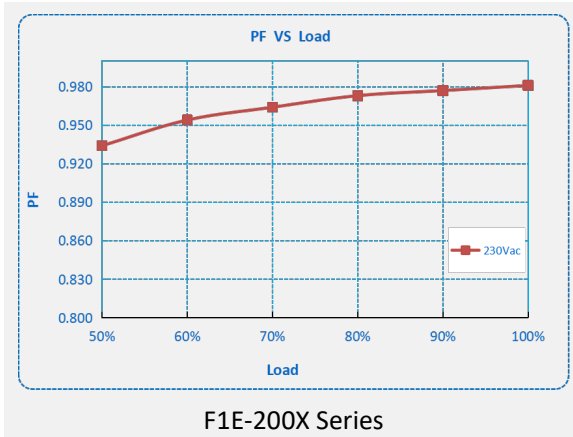

THD CURVE

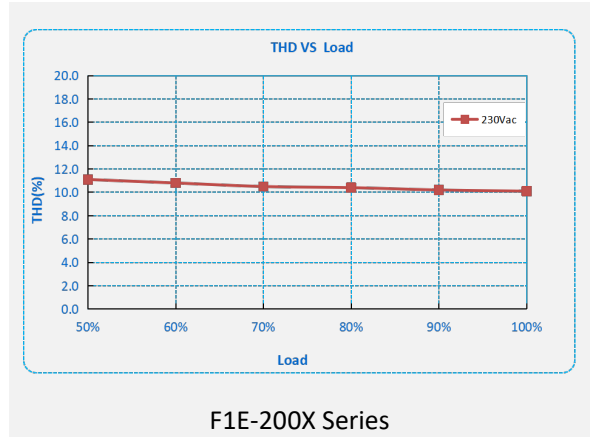

DERATING CURVE

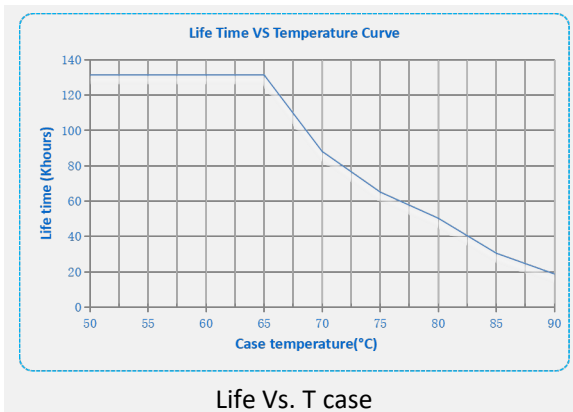
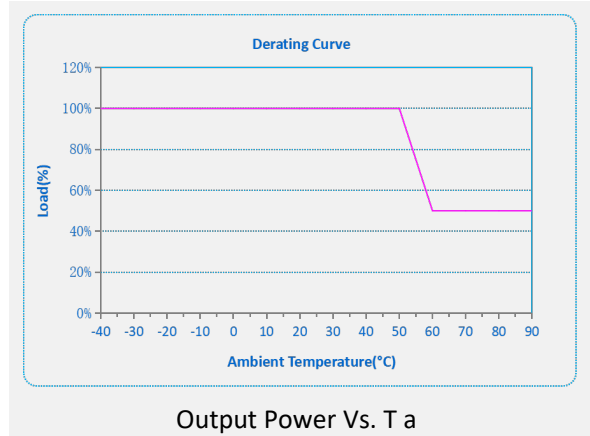
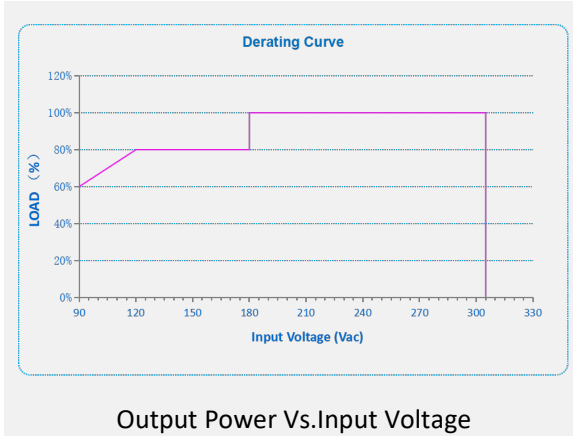

■ Dimming Curve

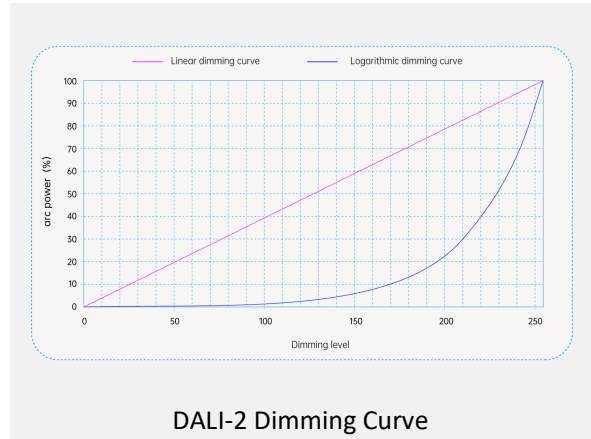
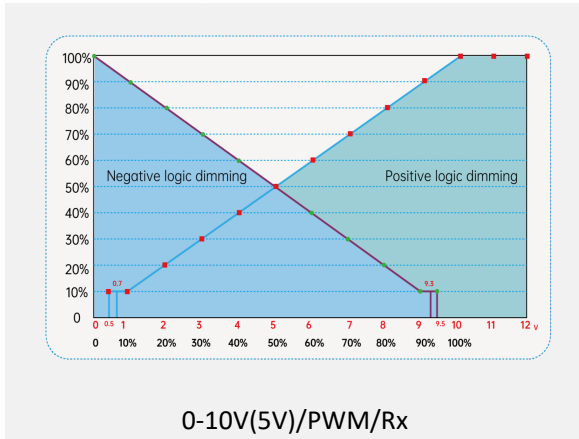

■ Timer dimming

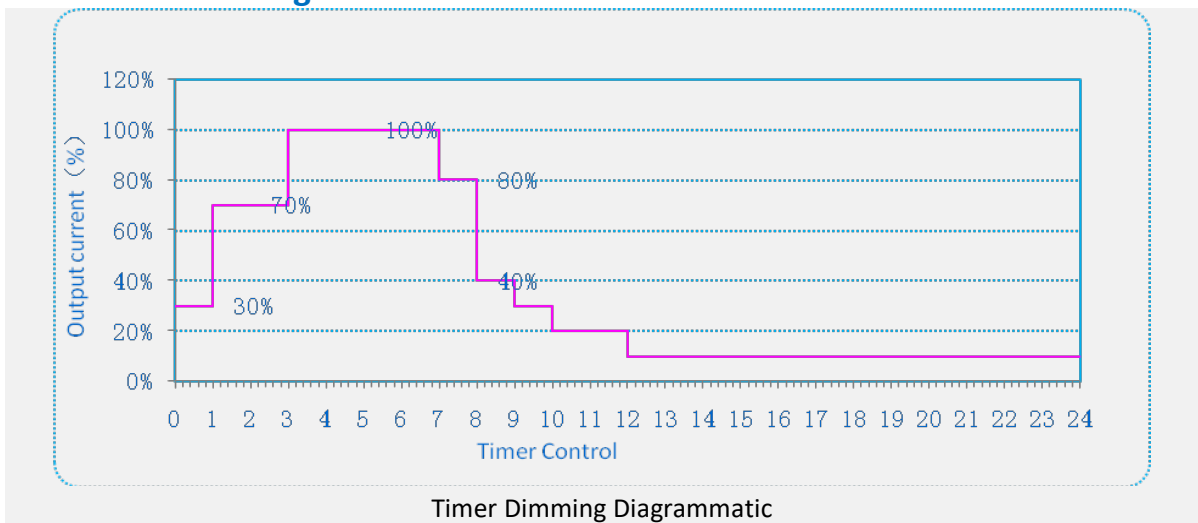

■ Mechanical Outline (unit: mm)

● Type B (Dimmable+off-line programmable)

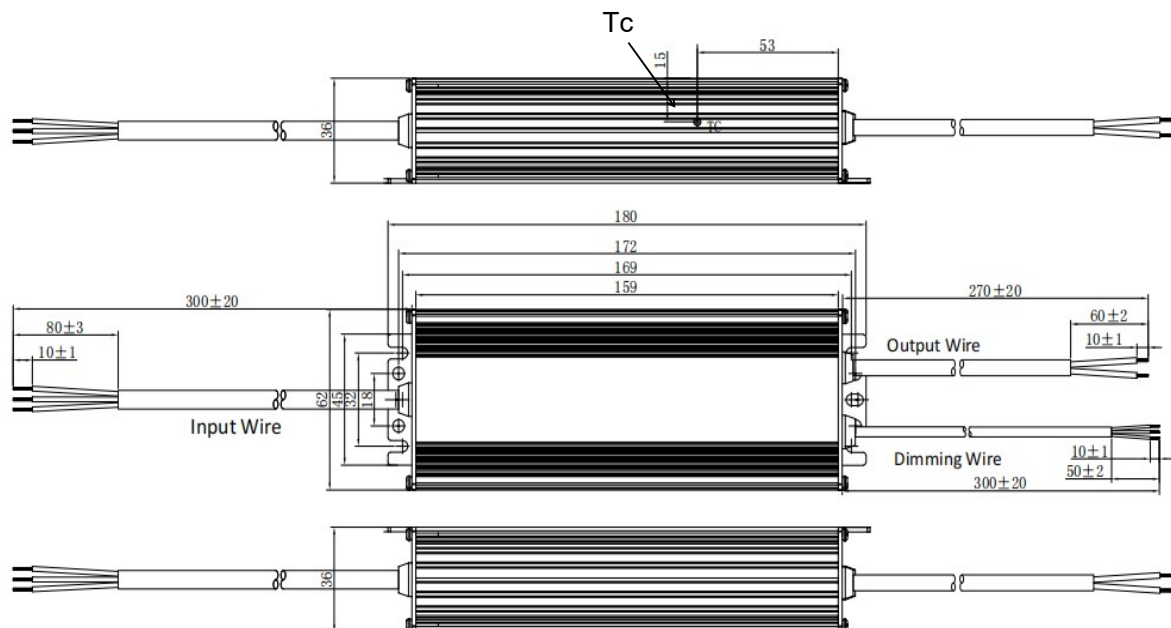

- **Type V (No Dimmable + potentiometer)**

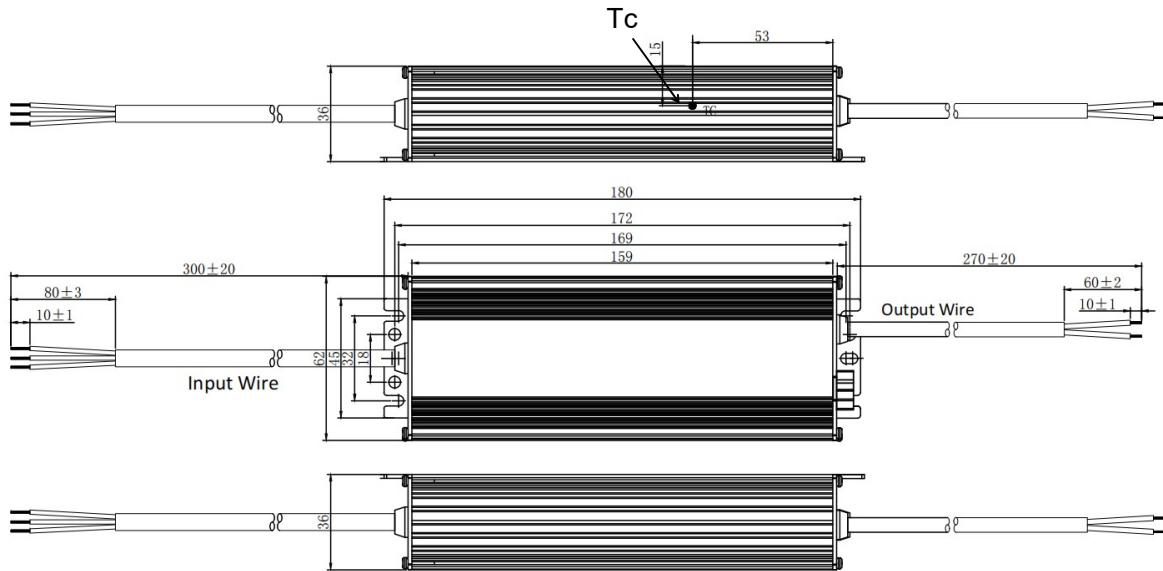

Wires	Specification	Remark
Input Wires	H05RN-F 3x1.0mm ² 300/500V L=300±20mm Brown: L, Blue: N, Yellow / Green: PE	CCC/VDE
Output Wires	H05RN-F 2x1.0mm ² 300/500V L=270±20mm Red: LED+, Black: LED -	CCC/VDE
Dimming/AUX.Wires (optional)	UL2517 22AWG*2C or 3C L=300±20mm Purple: DIM+, Pink: DIM-/12V-, Black and white: 12V+ (The 12V is optional)	UL

■ Installation considerations

1. The lightning protection level of the power supply meets the standard requirements of IEC61000-4-5 and other countries. If it is used in lightning-prone areas or areas with relatively complex power grid environment, it is recommended to install a professional lightning protection module on the AC input end of the power supply.
2. Please insulate and waterproof the dimming cable when it is not in use
3. The voltage-withstand of LED chip and Aluminum PCB >3KV
4. Safety space between Aluminum PCB and LED coppers >5mm.
5. The safety distance between LED+ and LED- on Aluminum PCB >1.8mm
6. Minimize copper on Aluminum PCB to reduce junction capacitance and leakage current
7. LED chip is recommended to be designed in parallel first and then in series

