

REV.	DESCRIPTION	DRAWN	CHECKED	APPROVED
A	NEW RELEASE	JLZ 03/15/16'	~	

N=No.of contact

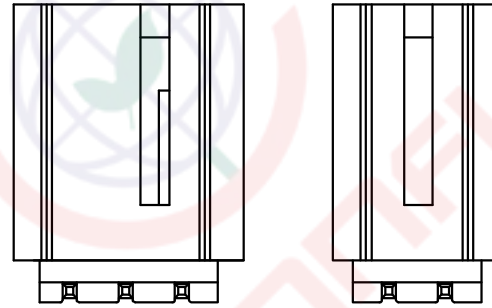
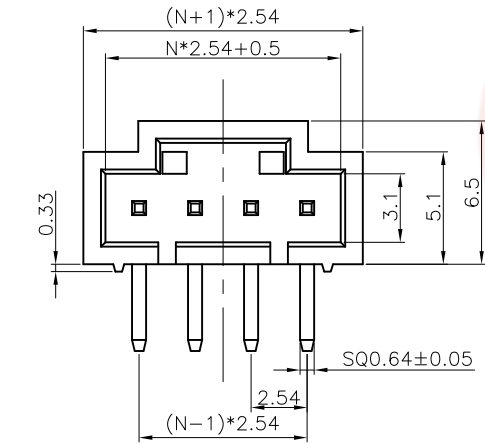

3P

2P

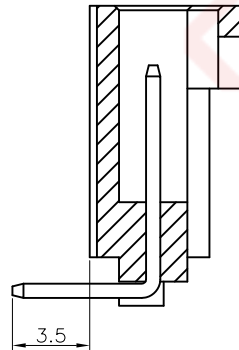
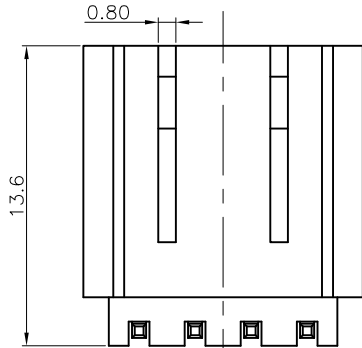

R: R/A type

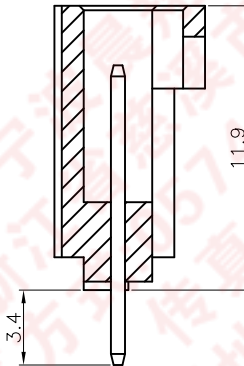

V: V/T type

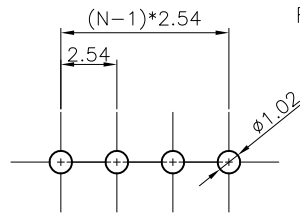

RECOMMEND PCB LAYOUT
(TOLERANCE ±0.05)

NOTES:

1. MAIN SPECIFICATIONS

- . Housing material: Thermoplastic
- . Contact material: Copper alloy
- . Rated voltage: 250V
- . Rated current: 3A
- . Contact resistance: $\leq 30m\Omega$
- . Insulation resistance: $\geq 1000M\Omega$
- . Withstanding voltage: 500V,AC 1 minute
- . Temperature range: -25 ~ +85°C

2. PRODUCT NUMBER CODE:

DS1070-06 - X X X X X

Housing Color
B: Black

Contact Plating
6: Tin 8: Gold flash

Mounting type
R: R/A type
V: V/T type

Connector type
M: Male

No.of contact
2 to 18

GENERAL TOLERANCE		ANGLE TOLERANCE	
X.	±0.60	X.	±5°
.X	±0.38	.X	±3°
.XX	±0.25	.XX	±2°

PROJECTION	TITLE
UNITS	2.54mm Wafer R/A & V/T Type
SHEET SIZE	SERIES DS1070-06 SERIES

DRAWING TYPE	CUSTOMER
SCALE	1:1 SHEET 1 OF 2
DRAWING NO.	C-DS1070-06-XXXXXX-A



晨翔电子有限公司

CONNFLY CONNFLY ELECTRONIC CO., LTD

REV.	DESCRIPTION	DRAWN	CHECKED	APPROVED
A	NEW RELEASE	JLZ 03/15/16'	~	

Housing

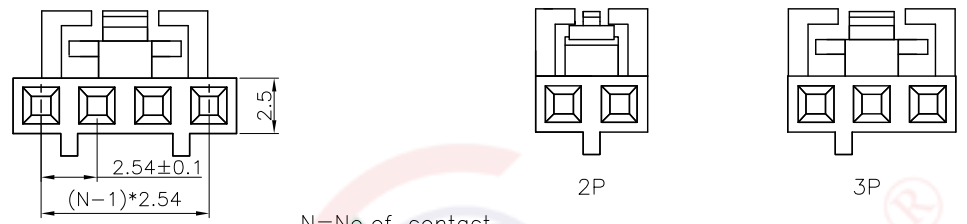

N=No.of contact

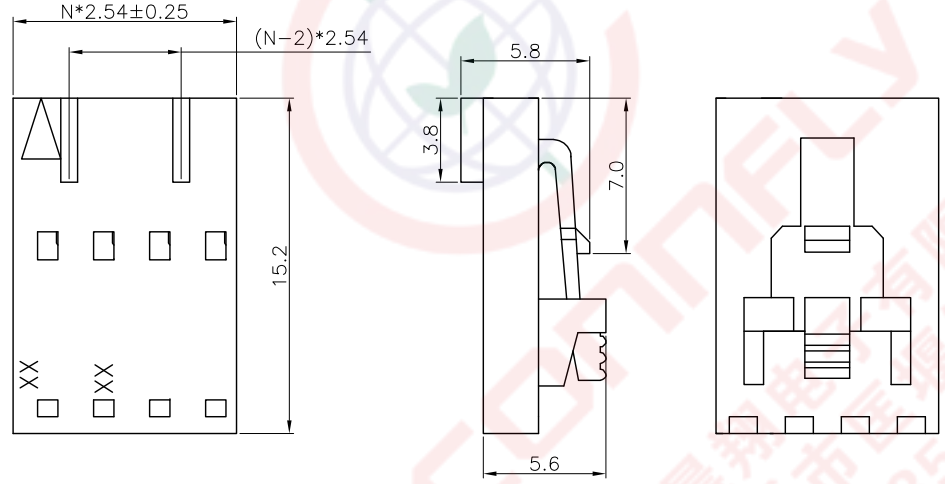

NOTES:

- MAIN SPECIFICATIONS
 - Housing material: Thermoplastic
 - Contact material: Copper alloy
 - Rated voltage: 250V
 - Rated current: 3A
 - Contact resistance: $\leq 30m\Omega$
 - Insulation resistance: $\geq 1000M\Omega$
 - Withstanding voltage: 500V, AC 1 minute
 - Temperature range: $-25 \sim +85^{\circ}C$
- PRODUCT NUMBER CODE:

Housing:

I - DS1070-06 - S C B 0 X
 Poles Of Housing 02~18
 Housing Color B: Black

Terminal

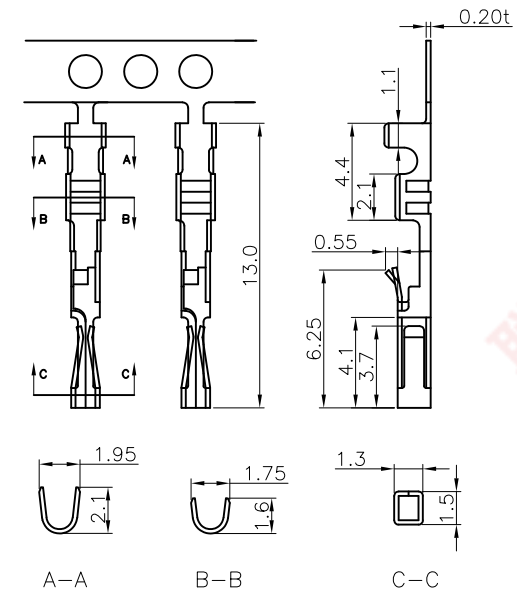

Terminal:

T - DS1070-06 - S C 6 0 0
 Contact Plating 6: Tin

GENERAL TOLERANCE		ANGLE TOLERANCE		PROJECTION		TITLE		
X.	±0.60	X.	±5°	UNITS	mm	2.54mm Wafer R/A & V/T Type		
.X	±0.38	.X	±3°	SHEET SIZE	A4	SERIES DS1070-06 SERIES		
.XX	±0.25	.XX	±2°					
DRAWING TYPE		CUSTOMER		晨翔电子有限公司 CONNFLY CONNFLY ELECTRONIC CO., LTD				
SCALE		1:1					SHEET 2 OF 2	
DRAWING NO.		C-DS1070-06-XXXXXX-A						