

REV.	DESCRIPTION	DRAWN	CHECKED	APPROVED
A	NEW RELEASE	JLZ 12/02/16'	~	

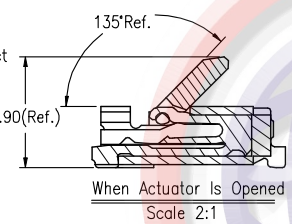

- NOTES:
- MATERIAL
 - INSULATOR: THERMOPLASTIC (UL 94V-0).
 - CONTACT: COPPER ALLOY.
 - SPECIFICATION
 - TEMPERATURE: -25°C ~ +85°C.
 - CONTACT RESISTANCE: 30mΩ max.
 - INSULATION RESISTANCE: 100MΩ min.
 - DIELECTRIC WITHSTANDING VOLTAGE: AC 100V PER MINUTE.
 - PRODUCT NUMBER CODE:
DS1020-21- X X X X X

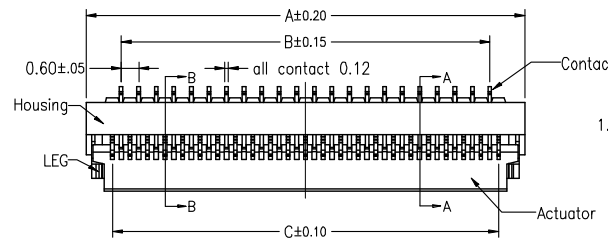
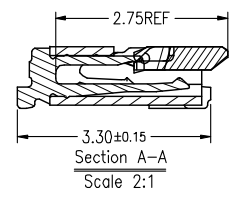
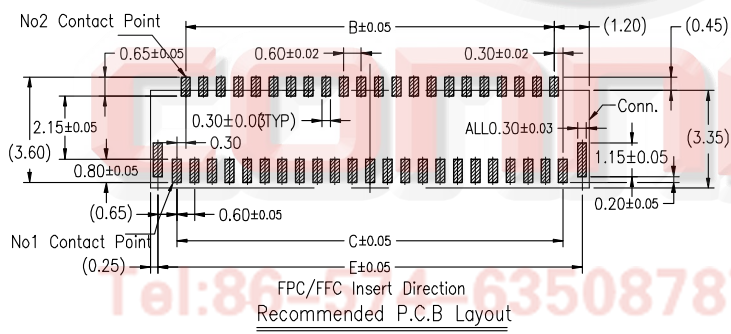
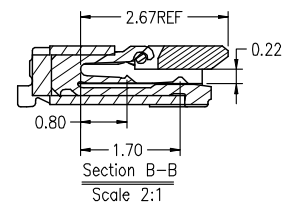
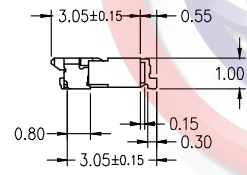
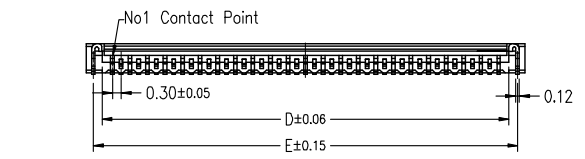

- PACKING TYPE
 - B: Tube
 - R: Tape on reel
- CONTACT PLATING
 - 8: Gold flash
- COVER COLOR
 - B: Black
- HOUSING COLOR
 - V: Ivory
- No. OF CONTACTS
 - 13~73

Tel: 86-574-63508787
 Fax: 86-574-63510817
 E-mail: sales@connfly.com
 http://www.connfly.com
 Add: Industry Zone KuangYan
 Town Cixi Ningbo China

Number of Contacts	Dimension				
	A	B	C	D	E
13	5.40	3.00	3.60	4.30	4.90
15	6.00	3.60	4.20	4.90	5.50
17	6.60	4.20	4.80	5.50	6.10
19	7.20	4.80	5.40	6.10	6.70
21	7.80	5.40	6.00	6.70	7.30
23	8.40	6.00	6.60	7.30	7.90
25	9.00	6.60	7.20	7.90	8.50
27	9.60	7.20	7.80	8.50	9.10
29	10.20	7.80	8.40	9.10	9.70
31	10.80	8.40	9.00	9.70	10.30
33	11.40	9.00	9.60	10.30	10.90
35	12.00	9.60	10.20	10.90	11.50
37	12.60	10.20	10.80	11.50	12.10
39	13.20	10.80	11.40	12.10	12.70
41	13.80	11.40	12.00	12.70	13.30
45	15.00	12.60	13.20	13.90	14.50
49	16.20	13.80	14.40	15.10	15.70
51	16.80	14.40	15.00	15.70	16.30
57	18.60	16.20	16.80	17.50	18.10
61	19.80	17.40	18.00	18.70	19.30
67	21.60	19.20	19.80	20.50	21.10
71	22.80	20.40	21.00	21.70	22.30
73	23.40	21.00	21.60	22.30	22.90

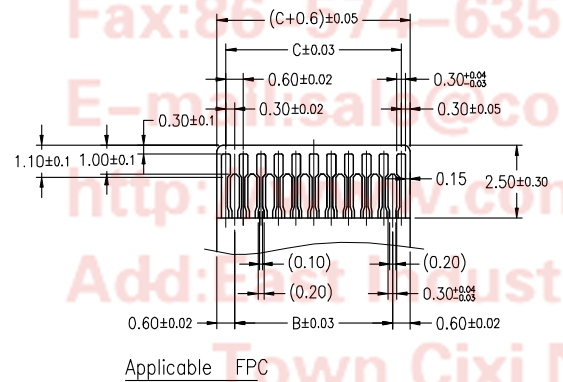

GENERAL TOLERANCE		ANGLE TOLERANCE		PROJECTION		TITLE	0.30mm FPC ZIF R/A Connector	
X.	±0.60	X.	±5°	UNITS	mm	H=1.0mm		
.X	±0.38	.X	±3°	SHEET SIZE	A4	SERIES	DS1020-21 SERIES	
.XX	±0.25	.XX	±2°	晨翔电子有限公司 CONNFLY CONNFLY ELECTRONIC CO. LTD				
DRAWING TYPE		CUSTOMER						
SCALE	1:1	SHEET	1 OF 1					
DRAWING NO.		C-DS1020-21-XXXXXX-A						