

**RoHS Compliant**  
**Drawing For Reference Only**

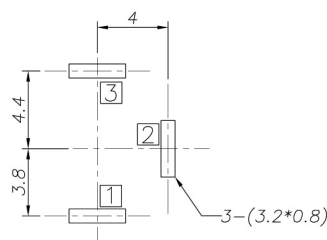

RECOMMENDED P. C. B. LAYOUT  
 UNSPECIFIED TOLERANCE: ±0.05  
 (TOP VIEW)

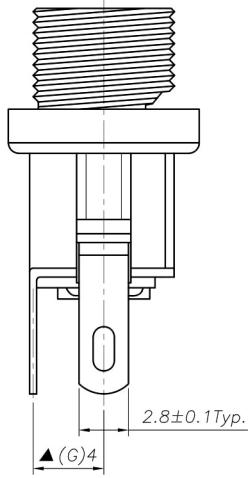
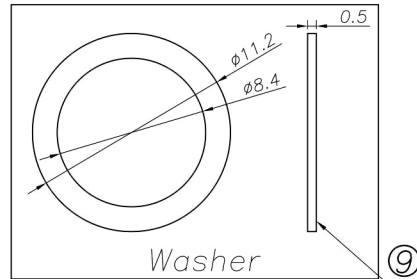
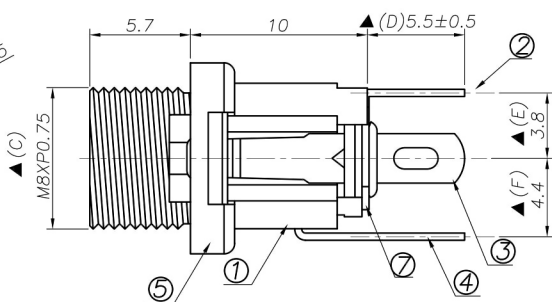
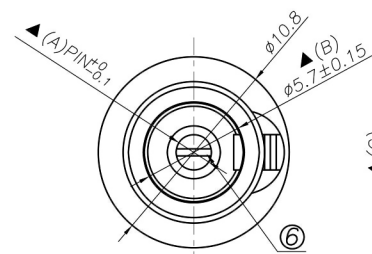
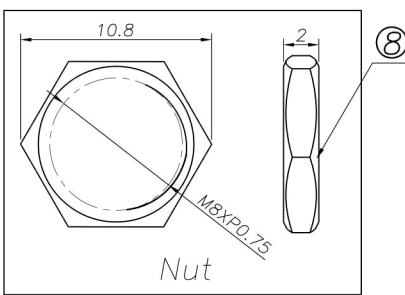

**Specification:**

1. Rating : DC 30V 3A.
2. Contact resistance:  $\leq 30m\Omega$ .  
After test:  $\leq 50m\Omega$
3. Insulation resistance:  $\geq 100M\Omega$  (500VDC).  
After test:  $\geq 50M\Omega$
4. Withstanding voltage: 500VAC.
5. Insertion and extraction force: 3N~30N.
6. life test: 5000cycles min.
7. Operation temperature range: -20°C~70°C.
8. Preservative temperature range: -40°C~85°C.
9. Sign "▲" is importance dimension.

Model No.	DS-026A(NB)	DS-026B(NB)
Pin	ø2.5	ø2.0

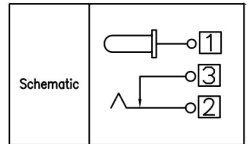

- Technical requirement :**
1. This product should meet EU RoHS related requirement.
  2. The surface of plastic part should be without any crackle such as burr,lack,and so on phenomenon.
  3. The surface of metal part should be without any defect such as scaur,nick,oxidation and plating problem.
  4. The electronic performance should be the same as spec.
  5. The un-specified tolerance is : <math>-6\pm 0.2</math>  
     6~20±0.3  
     >20±0.4

NO.	DESCRIPTION	QTY	MATERIAL	REMARK
⑨	Washer-2	1	Spcc	Nickel plating
⑧	Nut	1	Brass	Nickel plating
⑦	Washer-1	2	Bakelite	
⑥	Pin	1	Bronze	Nickel plating
⑤	Bushing	1	Brass	Nickel plating
④	Shunt Terminal	③ 1	Brass	Copper&tin plating
③	Tip Spring	② 1	Phosphor bronze	Copper&tin plating
②	Center pin terminal	① 1	Brass	Copper&tin plating
①	Housing	1	PBT	Black

**DCI DRAGON CITY INDUSTRIES LIMITED**

Item Name	DC POWER JACK	Tolerance :	Design	K.W Law	Remark	Scale
Item No.	DS-026(NB)	Unit : mm	Drawing	W.K Yeung	Remark	Material
			Check	K.L Wong	Remark	Drawing No.
			Approval	K.W Chan	Remark	Sheet