

The logo for DONE, featuring the word "DONE" in a bold, teal, sans-serif font. The letter "D" is stylized with a white circular element inside its top curve. The logo is contained within a white rounded square with a thin teal border.

DONE

MXK SERIES LED DRIVERS

DL-80H-GX-MXK SPEC E2.0

Features

- Suitable for class I/II luminaires
- Input voltage: AC 200-277 V ~ 50/60 Hz
- Efficiency :90%(Typ.)
- Constant power drive and constant current output control mode
- Plastic shell structure, protection grade: IP20
- Lightning protection level: differential mode 6kV, common mode 10kV
- Function selection:
 - Adjustable Output Current with NFC
 - Auxiliary source 24V/125mA
 - Integrated Bus Power Supply Based on DALI-2
 - Integrated Power Monitoring with High Accuracy
 - Provides external thermal protection with external NTC
 - DALI-2/D4i communication protocol (IEC62386-101/102/207/250/251/252/253)
- Lifetime design: 5 years



Applications

Road lighting、 Industrial lighting、 Venue lighting
 Floodlight lighting、 Landscape lighting 、 Plant lighting

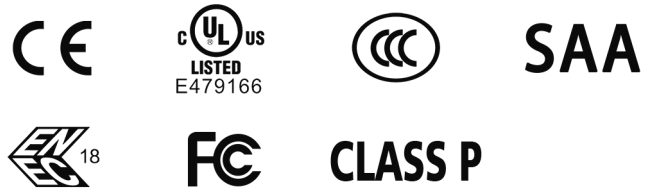

Model list

Model NO.	Input voltage	Output power	Output voltage	The default current	Eff.	T.H.D	PF
DL-80H-V115GX-MXK	AC 200-277V 50/60Hz	80W	46-115Vdc	0.7A	≥90%	≤10%	≥0.95

Note:

1. Test conditions of the above parameters: Ta=25℃, 230Vac input, full load operation for 30 minutes;
2. When the input is less than 180Vac, The output is turned off directly. When input 200-277VAC, rated power 80W, Please refer to “THE OUTPUT POWER VS INPUT VOLTAGE” curve chart for details.

Input characteristics

Parameter	Min	Typ.	Max	Note
Rated input voltage	200Vac	230Vac	277Vac	
Input voltage range	180Vac		305Vac	
Rated frequency	47Hz	50/60Hz	63Hz	
Power factor	0.95	-	-	@230Vac full load, rated input voltage
Power factor	0.9	-	-	65%-100% load, 200-277VAC input
T.H.D.	-	-	10%	@230Vac full load
T.H.D.	-	-	20%	65%-100% load, 200-277VAC input
AC power measurement	10%	-	100%	With 10-100% load, the power metering accuracy is $\pm 2\%$
Input current	-	-	0.5A	@200Vac full load
Inrush current	-	-	70A	230Vac, cold start (25°C)

Output characteristic

Parameter	Min	Typ.	Max	Note
Rated current DL-80H-V115GX-MXK	-	0.7A	-	
Output current range DL-80H-V115GX-MXK	0.5A	-	1.05A	
Output voltage range DL-80H-V115GX-MXK	46V	-	115V	
Rated power(150-180Vac)	0W	-	80W	The input voltage is less than 180Vac, the output is turned off directly
Rated power(180-277Vac)	-	80W	-	
No-load voltage DL-80H-V115GX-MXK	-	-	150V	
Efficiency@200Vac DL-80H-V115GX-MXK	90.03%	90.1%	-	full load@200Vac

Output characteristic

Parameter	Min	Typ.	Max	Note
Efficiency@230Vac DL-80H-V115GX-MXK	90.1%	90.3%	-	full load@230Vac
Output Current Ripple	-	5% Iomax	-	100% load, 20 MHz BW; Ripple =rms/ average
Accuracy of output current	-5%	-	+5%	full load
Line regulation	-3%	-	+3%	full load
Load regulation	-3%	-	+3%	full load
Starting time	-	-	1000ms	Full load@200-277Vac
Auxiliary source output voltage	21.6V	24V	26.4V	-
Auxiliary source output current	0 mA	-	125mA	Reference ground is "Dim -"
Auxiliary source output transient peak current @6W	-	-	250 mA	In a 5.0ms cycle, the maximum duration of the maximum peak current of 250mA is 2ms, and the average value must not exceed 250mA
Integrated bus power supply voltage	12Vdc	16Vdc	20Vdc	The output voltage is determined by the bus power supply load, and the reference point is DA+/DA-
Integrated bus power supply voltage	50mA	-	60mA	There is a short circuit protection function, and the reference point is DA+/DA-

Note:

- 1.The output current range is limited by the input and output voltage, please refer to "I-V WORKING AREA" for details.
- 2.By default, the DALI bus power supply is enabled and can be disabled by the programmer. When the bus power supply is required, the positive and negative terminals should be used to access the bus.

Dimming characteristic

Dimming function	Min	Typ.	Max	Instructions
DA+, DA- High voltage level	9.5V	16V	22.5V	
DA+, DA- Low voltage level	-	0V	6.5V	
DA+, DA- Current	-	-	2mA	
Dimming output range	10%Iout	-	100%Iout	

Note:

- 1.The standby power consumption is less than 0.5W when it is turned off. (The Bus power supply needs to be turned off)
- 2.DALI part: IEC62386-101/102/207/250/251/252/253.

Protection

Function		Function instructions			
Input under-voltage protection		When the input voltage is less than 180Vac $\pm 10\%$, The output is turned off directly.			
Output overload protection		Protection mode:hiccup mode,recovers automatically after fault condition is removed.			
Output short circuit protection		Hiccup mode:recovers automatically after fault condition is removed			
Over temperature protection		Self-recovery type: when the housing temperature is greater than 90℃, the output power decreases gradually.			
Output over-voltage protection		Protection mode: Hiccup mode or clamped in output highest voltage , the product is not damaged, LED driver works normally after fault condition is removed.			
Parameter		Min	Typ.	Max	Note
External Thermal Protection	External NTC resistance(R1)	-	1.272K	-	When the external NTC resistance value is reduced to R1, the output current begins to gradually decrease
	External NTC resistance(R2)	-	0.931K	-	When the external NTC resistance value is reduced to R2, the output current is reduced to the programmed current, which defaults to 25% lamp current
	Protection current when triggered external thermal protection	20%Iout	25%Iout	30%Iout	By default, when external thermal protection is triggered, the lamp outputs 25% Iout current

Note:

1. Unless otherwise specified, all specifications and parameters shall be measured at the conditions of 230Vac (50Hz), rated load and 25°C of ambient temperature;
2. Including setting error, line regulation and load regulation.
3. The recommended NTC model is the Murata NCP18XH103J03RB model with 10kΩ resistance.

Environmental

Environmental categories	Parameter
Working temperature	-40 ~ +55°C@200-277Vac, -40 ~ +45°C @180-200Vac (refer to "Life Curve ")
Max.Case Temp.	-40 ~ 90°C
Working humidity	20 ~ 95% RH, non condensing
Storage temperature, humidity	-40 ~ +80°C, 10 ~ 95% RH
Resistant to vibration	10 ~ 500Hz, 5G 12 min/cycle, X, Y, Z axis 72 min each
MTBF	230Khrs min. MIL-HDBK-217F (Ta=25°C)
Lifetime	70,000 hours @Tcase≤75°C,230Vac, 80% Load, Please refer to "Tcase VS Lifetime" section

Safety and EMC

Safety categories	Standard
Safety	GB19510.1、GB19510.14、EN61347-1、EN61347-2-13、IEC61347-1、IEC61347-2-13、AS/NZS61347.1、AS61347.2.13、EN 62384、 UL8750;
EMC	EN 55015、 EN 61000-3-2 、 GB/T 17743、 GB17625.1、 EN 61000-3-3
Surge protection	Differential mode L-N ±6KV (2 ohm), common mode L, N-PE± 10 KV (12 ohm); Refer to IEC61000-4-5 2014 Criterion B
High-pot test	I/P-O/P:3.75KVac I/P-PE :1.5KVac O/P-PE : 0.5KVac I/P-DIM:1.5KVac O/P-DIM:1.5KVac
Insulation impedance	I/P-PE:100MΩ / 500VDC; I/P-O/P:100MΩ / 500VDC / 25°C/ 70% RH
Leakage current	<0.7mA@277Vac

Note:

The driver is considered as a component that will be operated in combination with the final equipment. Since EMC performance will be affected by the complete installation, the final equipment manufacturers must re-qualify EMC Directive on the complete installation again.

I-V Working area

Output voltage VS output current of DL-80H-V115GX-MXK (input: 200-277Vac)

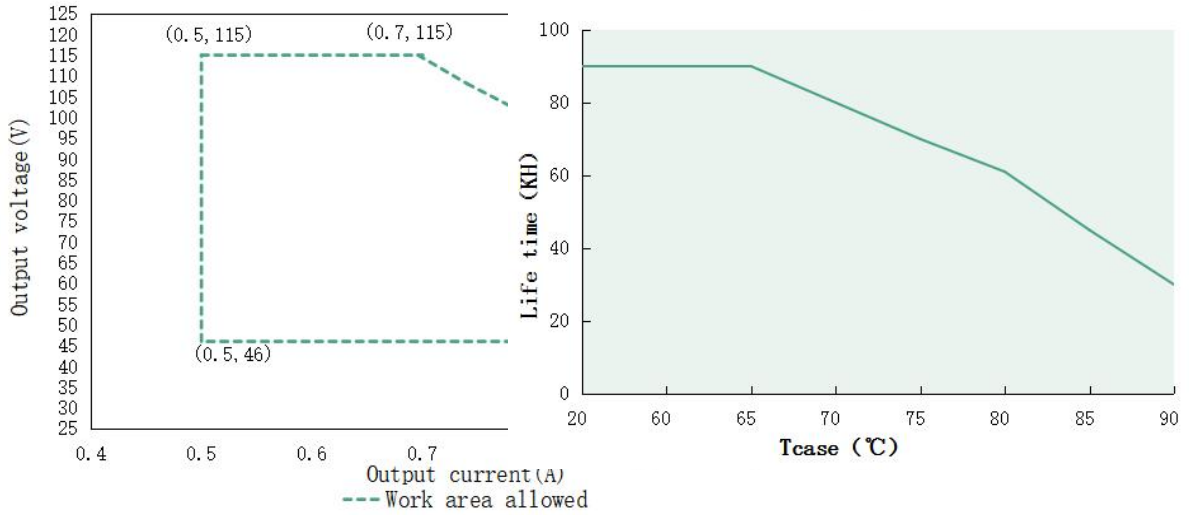

Load	Output								
Load working Voltage	46V	54V	65V	76V	85V	90V	96V	105V	115V
Io_MAX	1.05A	1.05A	1.05A	1.05A	0.94A	0.89A	0.83A	0.76A	0.7A
Po_MAX	48.3W	56.7W	68.3W	80W	80W	80W	80W	80W	80W

Eff. VS Output voltage(DL-80H-V115GX-MXK)

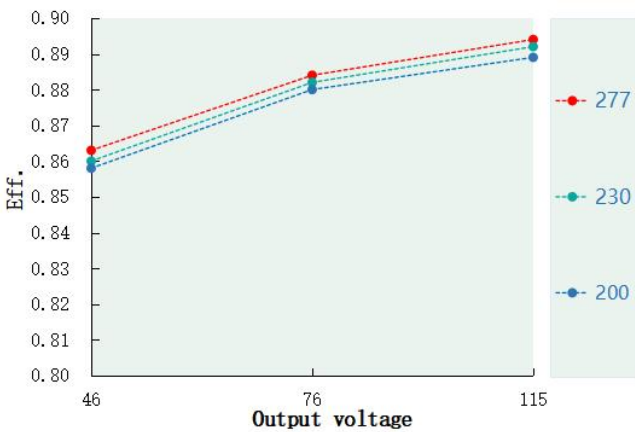

Power factor VS Input voltage(DL-80H-V115GX-MXK)

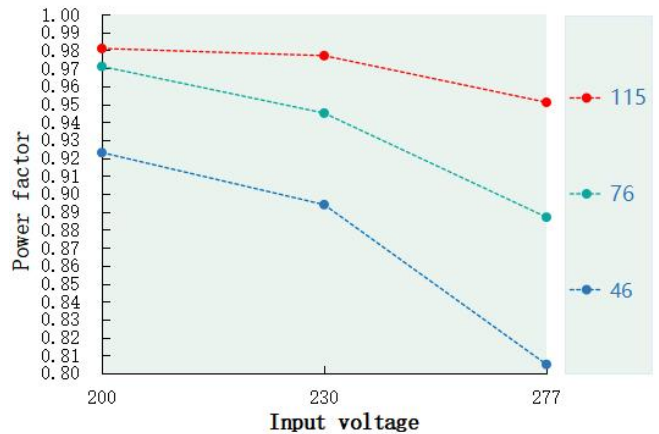

T.H.D. VS Output voltage(DL-80H-V115GX-MXK)



Tcase VS Lifetime (DL-80H-GX-MXK)

Output power VS Tcase (DL-80H-GX-MXK)

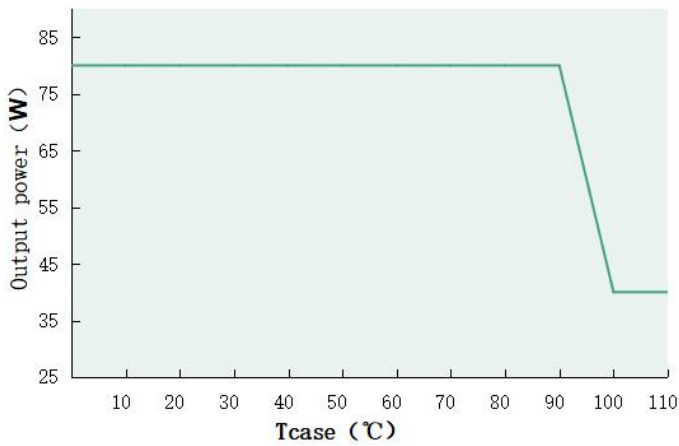

Inrush current(DL-80H-GX-MXK)

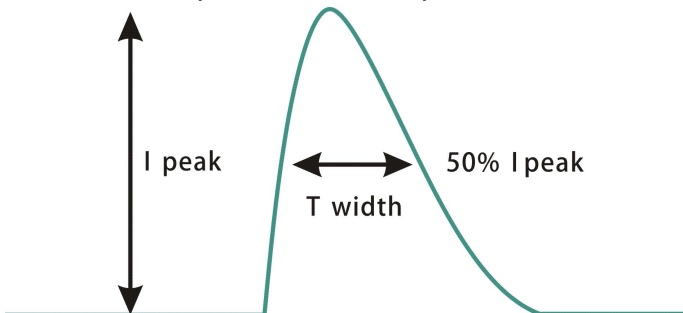

Input voltage	Peak current	T(@50% Peak current)
200Vac	42.9A	176us
230Vac	56.5A	173us
277Vac	65.3A	169us

Output power VS Input voltage

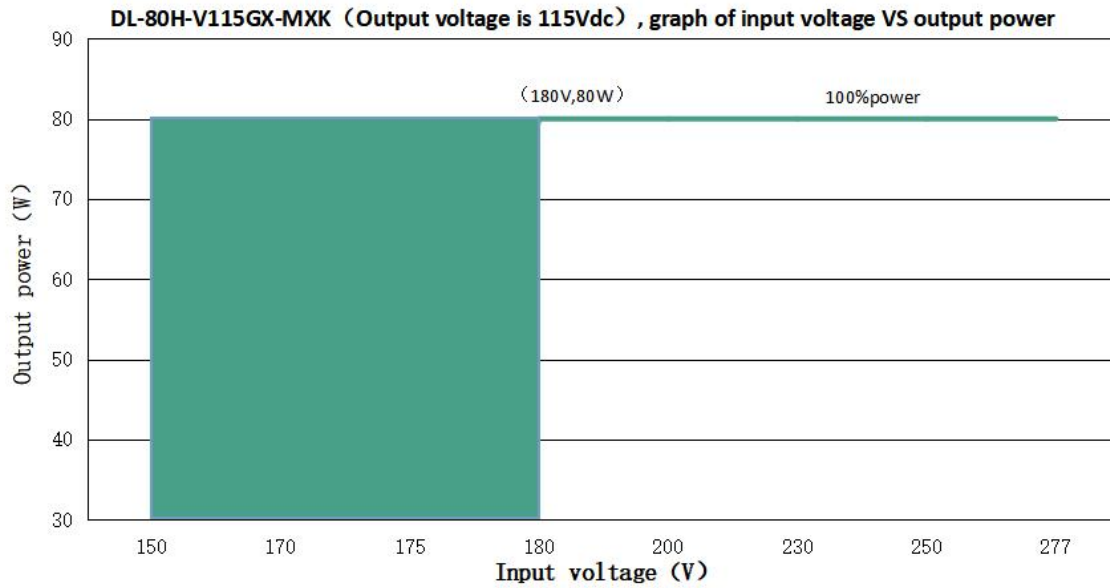

DL-80H-V115GX-MXK (When the output voltage is 158Vdc, the rated output current value and output power corresponding to different input voltage)

Input Voltage	150Vac	170Vac	175Vac	180Vac	200Vac	230Vac	250Vac	277Vac
Iout	0A	0.7A	0.7A	0.7A	0.7A	0.7A	0.7A	0.7A
Pout	0W	80W	80W	80W	80W	80W	80W	80W

Note:
 Output power will decrease gradually when input voltage less than 180Vac±10%;The output is turned off directly

Dimming curve

1.Logarithmic Dimming Curve

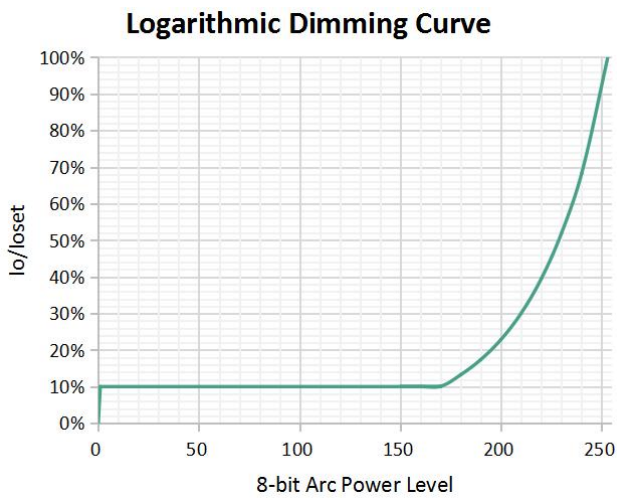

2.Linear Dimming Curve

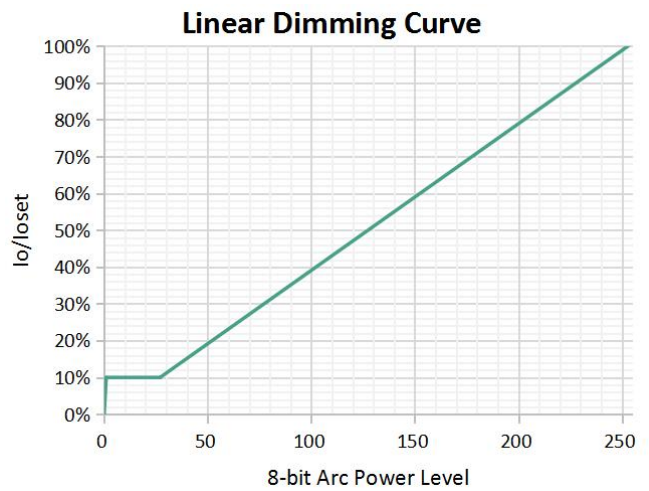

Note:
Factory default logarithmic dimming.

Programming connection diagram:



Mechanical specification

Size (mm) L133mm*W77mm*H33mm

DL-80H-V115GX-MXK

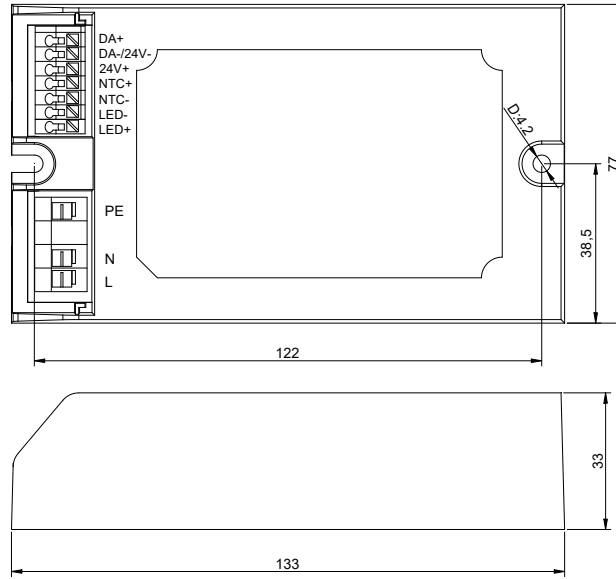

Weight

Weight 518g

Packaging

Packaging (mm) L330*W287*H206

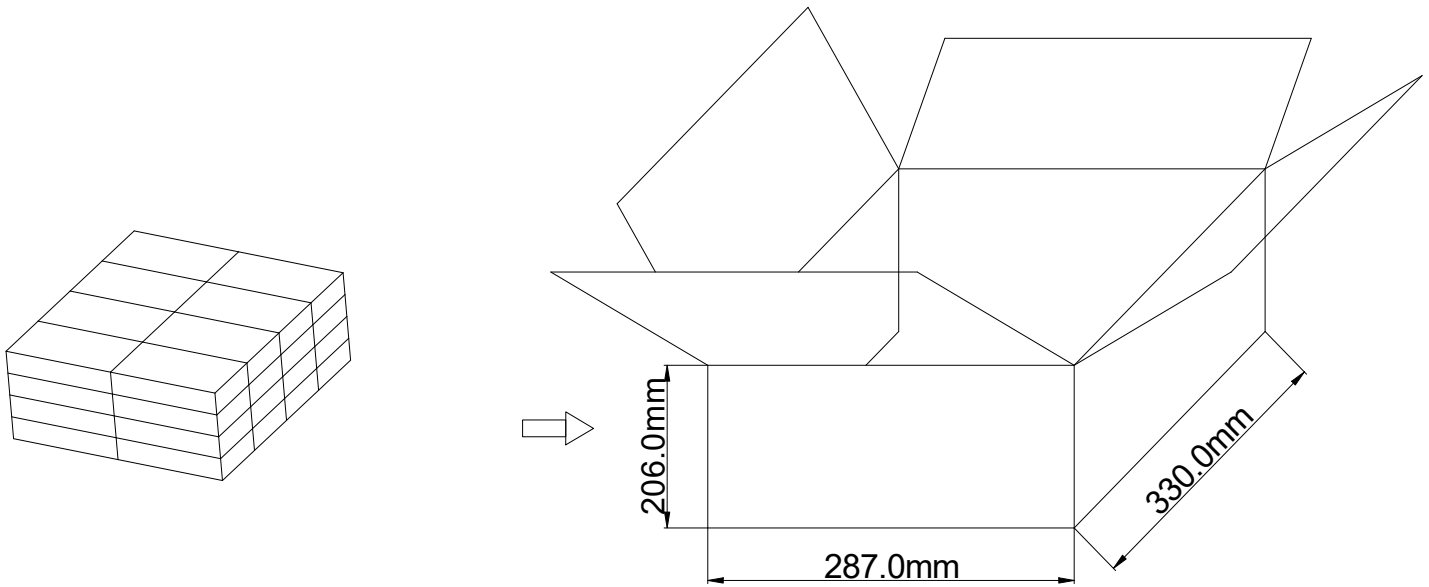

Note: One Carton 4 layers and 8 pcs each layer, total 32 pcs/carton.

Note:

1. According to the certificate obtained by the LED DRIVER, the LED DRIVER with the English label is sold in Europe, America and India.
2. The LED DRIVER with Chinese label is only used for China market.

Version

DATE	DESCRIPTION	REV.	CHECK
2024.4.28	Initial version.	E2.0	

MANUFACTURER		
EDIT	CHECK	APPROVE