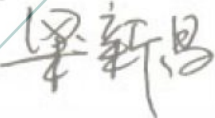
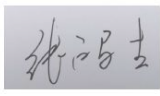
 广东东菱电源科技有限公司 Guangdong DonePower Technology Co.,Ltd 广东省中山市横栏镇康龙三路3号东菱工业园 咨询热线: 400-0760-585 WWW.DONEPOWER.COM.CN	产品类型	东菱 LED 室内驱动电源 DONE LED INTEGRATED SPECIAL DRIVER		
	产品系列	DL-60H-LAN	REV	1.2

广东东菱电源科技有限公司

客户承认书

Guangdong Done Power Technology Co.,Ltd.

SPECIFICATION

CUSTOMER			
MODEL NO.	DL-60H-LAN		
Rev.	V1.2		
SAMPLE DATE			
CUSTOMER CONFIRM			
PREPAR	CHECK	APPROVE	
Please return to us one copy of "SPECIFICATION FOR APPROVAL" with you approved signature.			
MANUFACTRUE			
EDIT	CHECK	APPROVE	
	 2021.03.23 08:14:03 +08'00'		数字签名者: 张鸿生 DN: cn=张鸿生, o, ou, email=978425630@qq.com, c=<无 日期: 2021.03.23 08:55:11 +08'00'
Guangdong Done Power Technology Co.,Ltd 广东东菱电源科技有限公司 No. 3-1&3-2, Kanglong 3rd Road, XinMao Industry Zone, Henglan Town, Zhongshan City, Guangdong Province, P. R. China Post code:528478 地址: 广东省中山市横栏镇新茂工业区康龙三路 3 号之一之二 邮编: 528478 TEL:0760-89838399 89838379 FAX:0760-89831157 89838396			

 广东东菱电源科技有限公司 Guangdong DonePower Technology Co., Ltd 广东省中山市横栏镇康龙三路3号东菱工业园 咨询热线: 400-0760-585 WWW.DONEPOWER.COM.CN	产品类型	东菱 LED 室内驱动电源 DONE LED INTEGRATED SPECIAL DRIVER		
	产品系列	DL-60H-LAN	REV	1.2

FEATURES

- ◇ Class II driver power supply
- ◇ AC input: 220-240V ~ 50/60Hz
- ◇ The input is 230Vac, the output is full, and the efficiency is up to 89%
- ◇ PF > 0.95 & THD < 10% full load
- ◇ The level of lightning surge is differential mode L-N Class II + /-1 KV (2 ohm). Refer to IEC61000-4-5 2014
- ◇ CCC/TUV/CE/SAA approved
- ◇ Ultra-long life design, warranty for 5 years



TYPICAL APPLICATIONS

Commercial lighting , Household lighting



MODEL LIST

Model	AC Input	Output voltage	Output current	Efficiency	THD	PF
				230Vac	230Vac	230Vac
DL-60H-C1300-LAN	220-240Vac 50/60Hz	25-42Vdc	1300mA	>89%	< 10%	>0.95
DL-60H-C1350-LAN	220-240Vac 50/60Hz	25-42Vdc	1350mA	>89%	< 10%	>0.95
DL-60H-C1400-LAN	220-240Vac 50/60Hz	25-42Vdc	1400mA	>89%	< 10%	>0.95
DL-60H-C1450-LAN	220-240Vac 50/60Hz	25-42Vdc	1450mA	>89%	< 10%	>0.95
DL-60H-C1500-LAN	220-240Vac 50/60Hz	25-42Vdc	1500mA	>89%	< 10%	>0.95

Remark: Default tested at 230Vac,full load with 30 minutes,Ta:25°C.

SPECIFICATION

 广东东菱电源科技有限公司 Guangdong DonePower Technology Co., Ltd 广东省中山市横栏镇康龙三路3号东菱工业园 咨询热线: 400-0760-585 WWW.DONEPOWER.COM.CN	产品类型	东菱 LED 室内驱动电源 DONE LED INTEGRATED SPECIAL DRIVER		
	产品系列	DL-60H-LAN	REV	1.2

◇ INPUT

Rated voltage	220 -240Vac
Voltage range	200 - 264Vac
Rated Frequency	50/60Hz
Power factor(PF)	@230Vac full load PF >0.95
Total harmonic distortion(THD)	@230Vac full load <10%
Input current	@230Vac full load 0.35A
Inrush current	@230Vac full load 70A

◇ OUTPUT

Model	DL-60H-C1300-LAN	DL-60H-C1350-LAN	DL-60H-C1400-LAN	DL-60H-C1450-LAN	DL-60H-C1500-LAN
Rated current	1300mA	1350mA	1400mA	1450mA	1500mA
Output current range	1235-1365mA	1282-1417mA	1330-1470mA	1377-1522mA	1425-1575mA
Output voltage range	25~42Vdc	25~42Vdc	25~42Vdc	25~42Vdc	25~42Vdc
Rated output power	54.6W	56.7W	58.8W	60.9W	63W
No load voltage	50V Max.	50V Max.	50V Max.	50V Max.	50V Max.
Efficiency	>89%@230Vac full load	>89%@230Vac full load	>89%@230Vac full load	>89%@230Vac full load	>89%@230Vac full load
Accuracy off output current	±5%	±5%	±5%	±5%	±5%
Line regulation	±3%	±3%	±3%	±3%	±3%
Load regulation	±3%	±3%	±3%	±3%	±3%
Setup time	<500ms @ 230Vac	<500ms @230Vac	<500ms @ 230Vac	<500ms @ 230Vac	<500ms @ 230Vac

◇ PROTECTION

 广东东菱电源科技有限公司 Guangdong DonePower Technology Co., Ltd 广东省中山市横栏镇康龙三路3号东菱工业园 咨询热线: 400-0760-585 WWW.DONEPOWER.COM.CN	产品类型	东菱 LED 室内驱动电源 DONE LED INTEGRATED SPECIAL DRIVER		
	产品系列	DL-60H-LAN	REV	1.2

Over load	Non-latching : Constant current limiting, recovers automatically after fault condition is removed.
Short	Hiccup and non-latching,;recover automatically after fault condition is removed.
Over voltage	hiccup or when it is at the highest point of output voltage the product would not be hurt when the fault is excluded or is start working again the power supply is working normally.

NOTE :

- 1) All parameters NOT specially mentioned are measured at 230VAC (50Hz)input, rated load and 25°C of ambient temperature.
- 2) Tolerance : includes set up tolerance, line regulation and load regulation.
- 3) Constant current operation region is within 50% ~100% rated output voltage. This is the suitable operation region for LED related applications.

ENVIRONMENT

WORKING TEMP.	-25 ~ +50°C (Refer to "Derating Curve")
WORKING HUMIDITY	20 ~ 95% RH, non-condensing
STORAGE TEMP, HUMIDITY	-25 ~ +80°C, 10 ~ 95% RH
VIBRATION	10 ~ 500Hz, 5G 12min./1cycle, period for 72min. each along X, Y, Z axes
WITHSTAND VOLTAGE	I/P-O/P:3.75KVAC
ISOLATION RESISTANCE	I/P-O/P:100M Ohms / 500VDC / 25°C/ 70% RH
MTBF	470K hrs min. MIL-HDBK-217F (25°C)

SAFETY & EMC

SAFETY	GB19510.1、GB19510.14、EN61347-1、EN61347-2-13、IEC61347-1、IEC61347-2-13、AS/NZS61347.1、AS/NZS61347.2.13 ; GB19510.1、GB19510.14、EN61347-1、EN61347-2-13、IEC61347-1、IEC61347-2-13、AS/NZS61347.1、AS/NZS61347.2.13 ;
EMC	EN 55015、EN 61000-3-2 、GB/T 17743、GB17625.1、 EN 61000-3-3
SUGER	The level of lightning surge is differential mode L-N Class II + /-1 KV (2 ohm) (IEC61000-4-5 2014)
LEAKAGE CURRENT	<0.7mA / 230Vac

NOTE :

The power supply is considered as a component that will be operated in combination with final equipment. Since EMC performance will be affected by the complete installation, the final equipment manufacturers must re-qualify EMC Directive on the complete installation again.

Output voltage VS power factor

Output voltage VS THD

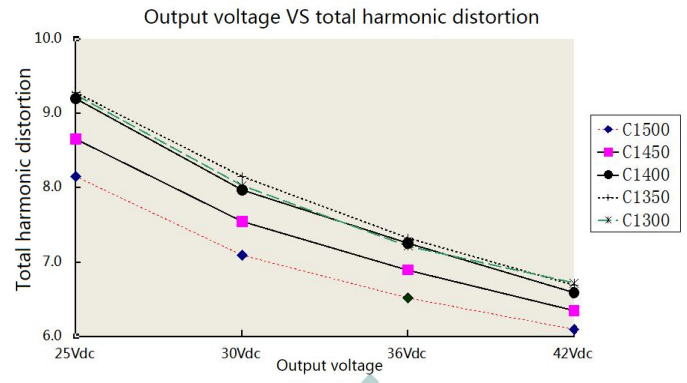
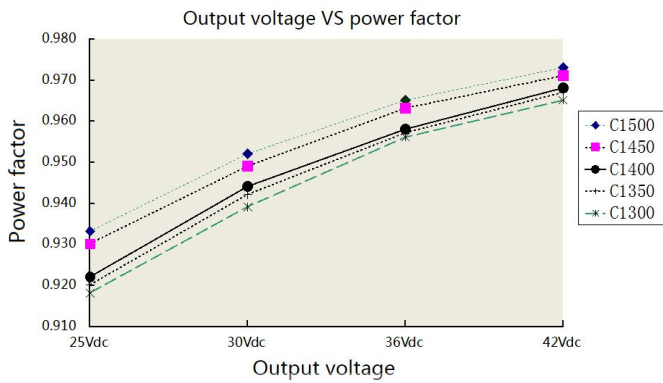

Output voltage VS efficiency

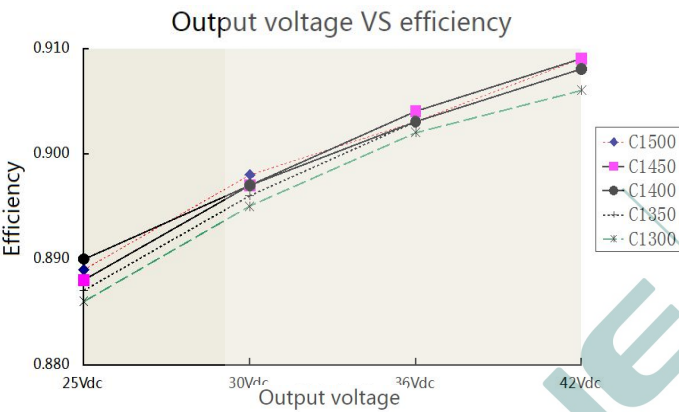

Input voltage VS output load

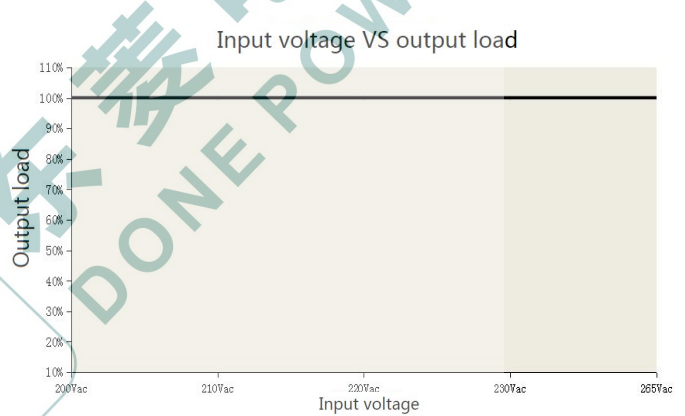

Reduction curve

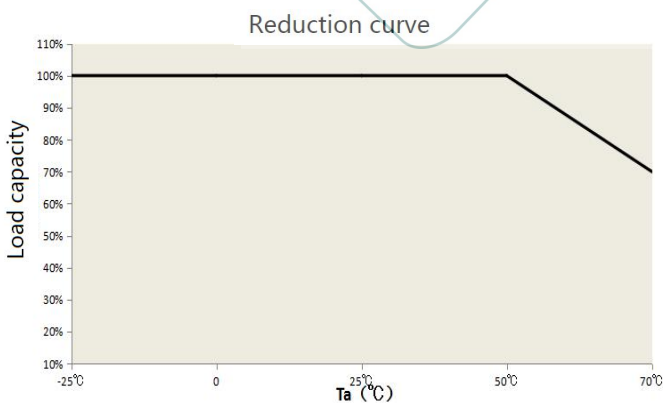

Service life curve

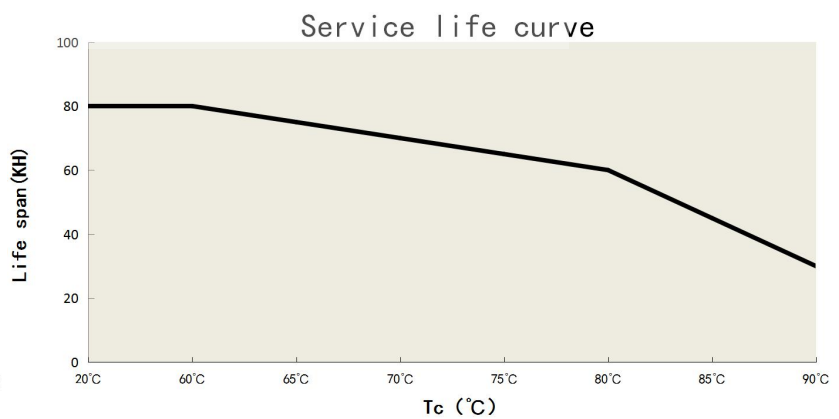

MECHANICAL SPECIFICATION & PACKING :

DIMENSION (mm)

139*45*30

 广东东菱电源科技有限公司 Guangdong DonePower Technology Co., Ltd 广东省中山市横栏镇康龙三路3号东菱工业园 咨询热线: 400-0760-585 WWW.DONEPOWER.COM.CN	产品类型	东菱 LED 室内驱动电源 DONE LED INTEGRATED SPECIAL DRIVER		
	产品系列	DL-60H-LAN	REV	1.2

PACKING	/
---------	---

Case No. : FP05 Unit :mm

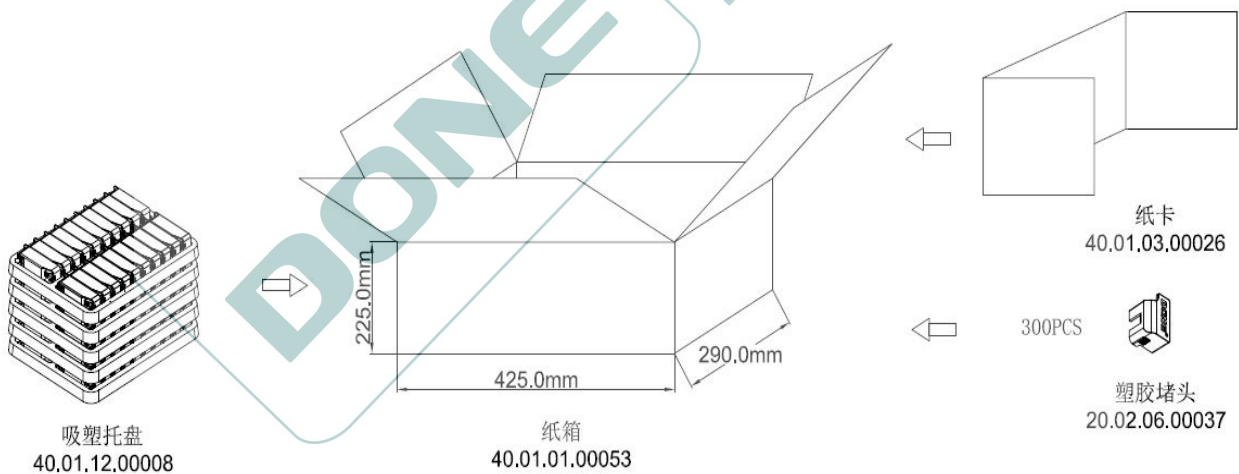
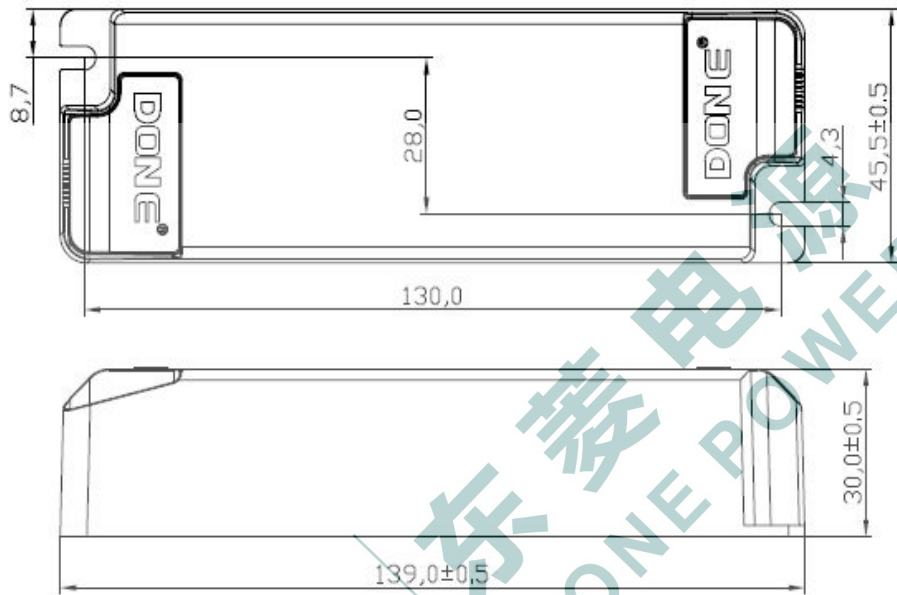

注：一箱5层，每层20PCS

WEIGHT

WEIGHT	160g/PCS
--------	----------

Warning:

1. According to the certificate of power supply The LED driver of English nameplate is

 广东东菱电源科技有限公司 Guangdong DonePower Technology Co., Ltd 广东省中山市横栏镇康龙三路3号东菱工业园 咨询热线: 400-0760-585 WWW.DONEPOWER.COM.CN	产品类型	东菱 LED 室内驱动电源 DONE LED INTEGRATED SPECIAL DRIVER		
	产品系列	DL-60H-LAN	REV	1.2

suitable for sale to Europe, America and India;

2.LED drivers for Chinese nameplates are only available for lamps sold to China.

