

The logo for DONE, featuring the word "DONE" in a bold, teal, sans-serif font. The letter "D" is stylized with a white circular element on its left side. The logo is contained within a white rounded rectangle with a thin teal border.

MXK SERIES LED DRIVERS

DL-40H-GX-MXK SPEC E4.0

Features

- Suitable for class I/II luminaires
- Input voltage: AC 200-277 V ~ 50/60 Hz
- Efficiency :87.5%(Typ.)
- Constant power drive and constant current output control mode
- Plastic shell structure, protection grade: IP20
- Lightning protection level: differential mode 6kV, common mode 10kV
- Function selection:
 - Adjustable Output Current with NFC
 - Auxiliary source 24V/125mA
 - Integrated Bus Power Supply Based on DALI-2
 - Integrated Power Monitoring with High Accuracy
 - Provides external thermal protection with external NTC
 - DALI-2/D4i communication protocol (IEC62386-101/102/207/250/251/252/253)
- Lifetime design: 5 years



Applications

Road lighting、 Industrial lighting、 Venue lighting
 Floodlight lighting、 Landscape lighting 、 Plant lighting



Model list

Model NO.	Input voltage	Output power	Output voltage	The default current	Eff.	T.H.D	PF
DL-40H-V58GX-MXK	AC 200-277V 50/60Hz	40W	25-58Vdc	0.7A	≥87.5%	≤10%	≥0.95

Note:

1. Test conditions of the above parameters: Ta=25°C, 230Vac input, full load operation for 30 minutes;
2. When the input is less than 180Vac, the output is turned off directly;When input 200-277VAC, rated power 40W, Please refer to “THE OUTPUT POWER VS INPUT VOLTAGE” curve chart for details.

Input characteristics

Parameter	Min	Typ.	Max	Note
Rated input voltage	200Vac	230Vac	277Vac	
Input voltage range	180Vac		305Vac	
Rated frequency	47Hz	50/60Hz	63Hz	
Power factor	0.95	-	-	@230Vac full load, rated input voltage
Power factor	0.9	-	-	65%-100% load, 200-277VAC input
T.H.D.	-	-	10%	@230Vac full load
T.H.D.	-	-	20%	65%-100% load, 200-277VAC input
AC power measurement	10%	-	100%	With 10-100% load, the power metering accuracy is $\pm 2\%$
Input current	-	-	0.3A	@200Vac full load
Inrush current	-	-	50A	230Vac, cold start (25°C)

Output characteristic

Parameter	Min	Typ.	Max	Note
Rated current DL-40H-V58GX-MXK	-	0.7A	-	
Output current range DL-40H-V58GX-MXK	0.5A	-	1.05A	
Output voltage range DL-40H-V58GX-MXK	25V	-	58V	
Rated power(150-180Vac)	0	-	40W	The input voltage is less than 180 Vac directly shut off, see the ating curve for details
Rated power(180-277Vac)	-	40W	-	
No-load voltage DL-40H-V58GX-MXK	-	-	75V	
Efficiency@200Vac DL-40H-V58GX-MXK	86%	87%	-	full load@200Vac

Output characteristic

Parameter	Min	Typ.	Max	Note
Efficiency@230Vac DL-40H-V58GX-MXK	87%	87.5%	-	full load@230Vac
Output Current Ripple	-	5% I _{omax}	-	100% load, 20 MHz BW; Ripple =rms/ average
Accuracy of output current	-5%	-	+5%	100% Load Constant power range
Line regulation	-3%	-	+3%	100% Load Constant power range
Load regulation	-3%	-	+3%	100% Load Constant power range
Starting time	-	-	1000ms	Full load@200-277Vac
Auxiliary source output voltage	21.6V	24V	26.4V	-
Auxiliary source output current	0 mA	-	125mA	Reference ground is "Dim -"
Auxiliary source output transient peak current @6W	-	-	250 mA	In a 5.0ms cycle, the maximum duration of the maximum peak current of 250mA is 2ms, and the average value must not exceed 250mA
Integrated bus power supply voltage	12Vdc	16Vdc	20Vdc	The output voltage is determined by the bus power supply load, and the reference point is DA+/DA-
Integrated bus power supply voltage	50mA	-	60mA	There is a short circuit protection function, and the reference point is DA+/DA-

Note:

- 1.The output current range is limited by the input and output voltage, please refer to "I-V WORKING AREA" for details.
- 2.By default, the DALI bus power supply is enabled and can be disabled by the programmer. When the bus power supply is required, the positive and negative terminals should be used to access the bus.

Dimming characteristic

Dimming function	Min	Typ.	Max	Instructions
DA+, DA- High voltage level	9.5V	16V	22.5V	
DA+, DA- Low voltage level	-	0V	6.5V	
DA+, DA- Current	-	-	2mA	
Dimming output range	10%Iout	-	100%Iout	

Note: .

- 1.The standby power consumption is less than 0.5W when it is turned off. (The Bus power supply needs to be turned off)
- 2.DALI part: IEC62386-101/102/207/250/251/252/253.

Protection

Function		Function instructions			
Input under-voltage protection		When the input voltage is less than 180Vac $\pm 10\%$, the Output is turned off directly, see derating curve for details			
Output overload protection		Protection mode:hiccup mode,recovers automatically after fault condition is removed.			
Output short circuit protection		Hiccup mode:recovers automatically after fault condition is removed			
Over temperature protection		Self-recovery type: when the housing temperature is greater than 90°C, the output power decreases gradually.			
Output over-voltage protection		Protection mode: Hiccup mode or clamped in output highest voltage , the product is not damaged, LED driver works normally after fault condition is removed.			
Parameter		Min	Typ.	Max	Note
External Thermal Protection	External NTC resistance(R1)	-	1.272K	-	When the external NTC resistance value is reduced to R1, the output current begins to gradually decrease
	External NTC resistance(R2)	-	0.931K	-	When the external NTC resistance value is reduced to R2, the output current is reduced to the programmed current, which defaults to 25% lamp current
	Protection current when triggered external thermal protection	20%Iout	25%Iout	30%Iout	By default, when external thermal protection is triggered, the lamp outputs 25% Iout current

Note:

1. Unless otherwise specified, all specifications and parameters shall be measured at the conditions of 230Vac (50Hz), rated load and 25°C of ambient temperature;
2. Including setting error, line regulation and load regulation.
3. The recommended NTC model is the Murata NCP18XH103J03RB model with 10kΩ resistance.

Environmental

Environmental categories	Parameter
Working temperature	-40 ~ +55°C@200-277Vac, -40 ~ +45°C @180-200Vac (refer to "Life Curve ")
Max.Case Temp.	-40 ~ 90°C
Working humidity	20 ~ 95% RH, non condensing
Storage temperature, humidity	-40 ~ +80°C, 10 ~ 95% RH
Resistant to vibration	10 ~ 500Hz, 5G 12 min/cycle, X, Y, Z axis 72 min each
MTBF	230Khrs min. MIL-HDBK-217F (Ta=25°C)
Lifetime	70,000 hours @Tcase≤75°C, 230Vac, 80% Load, Please refer to "Tcase VS Lifetime" section

Safety and EMC

Safety categories	Standard
Safety	GB19510.1、GB19510.14、EN61347-1、EN61347-2-13、IEC61347-1、IEC61347-2-13、AS/NZS61347.1、AS61347.2.13、EN 62384、UL8750;
EMC	EN 55015、EN 61000-3-2 、GB/T 17743、GB17625.1、EN 61000-3-3
Surge protection	Differential mode L-N ±6KV (2 ohm), common mode L, N-PE± 10 KV (12 ohm); Refer to IEC61000-4-5 2014 Criterion B
High-pot test	I/P-O/P:3.75KVac I/P-PE :1.5KVac O/P-PE : 0.5KVac I/P-DIM:1.5KVac O/P-DIM:1.5KVac
Insulation impedance	I/P-PE:100MΩ / 500VDC; I/P-O/P:100MΩ / 500VDC / 25°C/ 70% RH
Leakage current	<0.7mA@277Vac

Note:

The driver is considered as a component that will be operated in combination with the final equipment. Since EMC performance will be affected by the complete installation, the final equipment manufacturers must re-qualify EMC Directive on the complete installation again.

I-V Working area

Output voltage VS output current of DL-40H-V58GX-MXK (input: 200-277Vac)

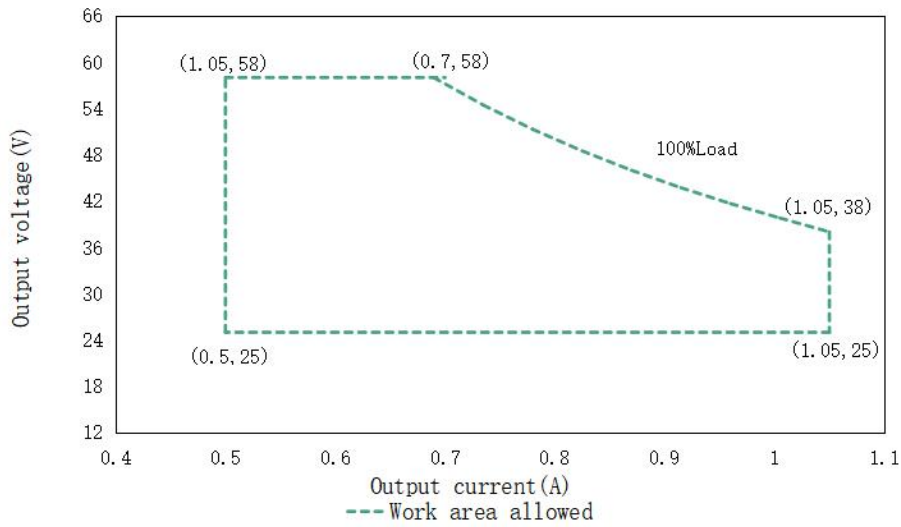

Load	Output								
Load working Voltage	25V	29V	33V	38V	42V	46V	50V	54V	58V
Io_MAX	1.05A	1.05A	1.05A	1.05A	0.95A	0.87A	0.80A	0.74A	0.7A
Po_MAX	26.25W	30.45W	34.65W	40W	40W	40W	40W	40W	40W

Eff. VS Output voltage(DL-40H-V58GX-MXK)

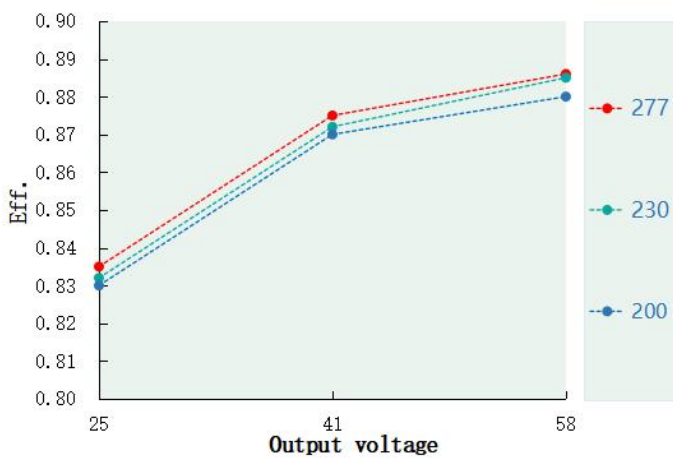

Power factor VS Input voltage(DL-40H-V58GX-MXK)

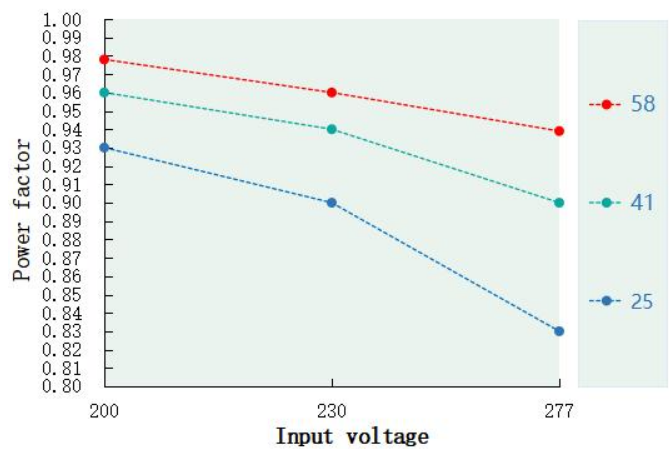

T. H. D. VS Output voltage(DL-40H-V58GX-MXK)

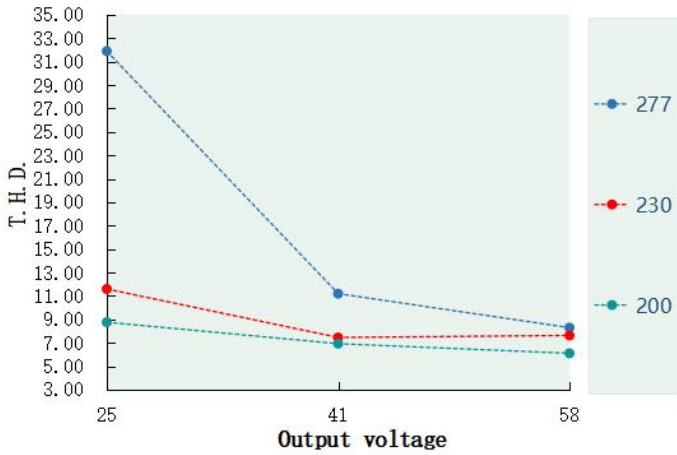

Tcase VS Lifetime (DL-40H-GX-MXK)

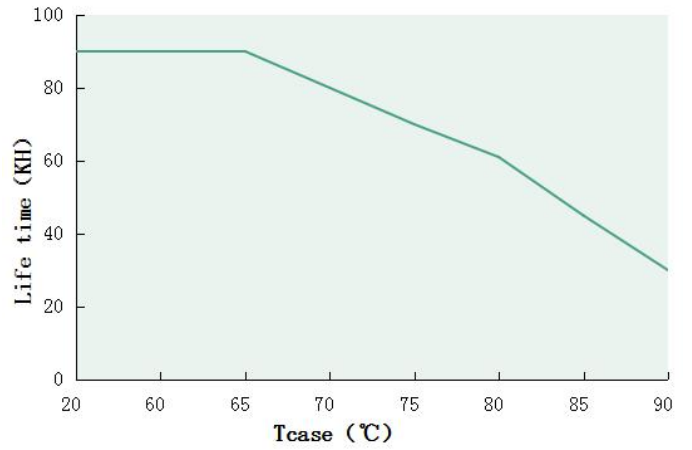

Output power VS Tcase (DL-40H-GX-MXK)

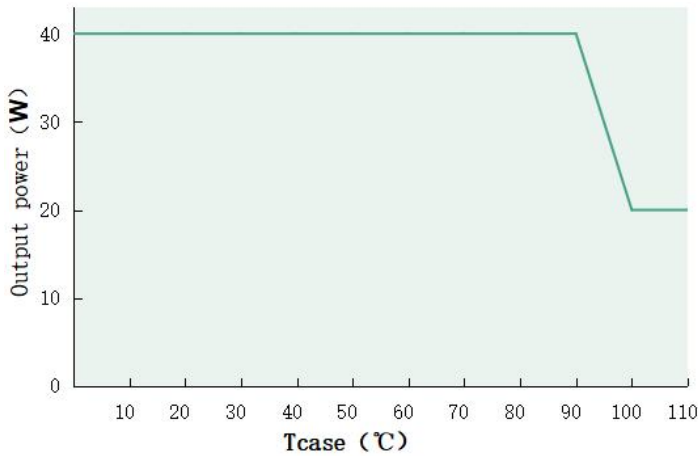

Inrush current(DL-40H-GX-MXK)

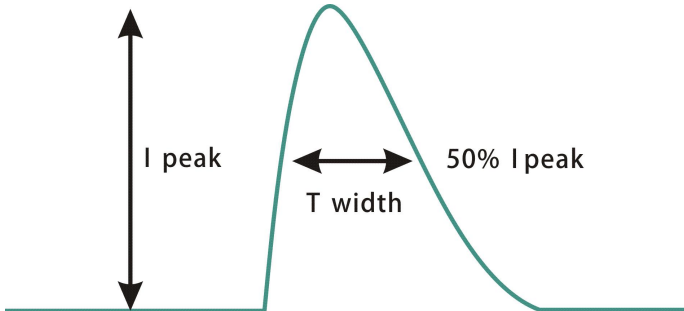

Input voltage	Peak current	T(@50% Peak current)
200Vac	20A	168us
230Vac	37.5A	167us
277Vac	45.2A	166us

Output power VS Input voltage

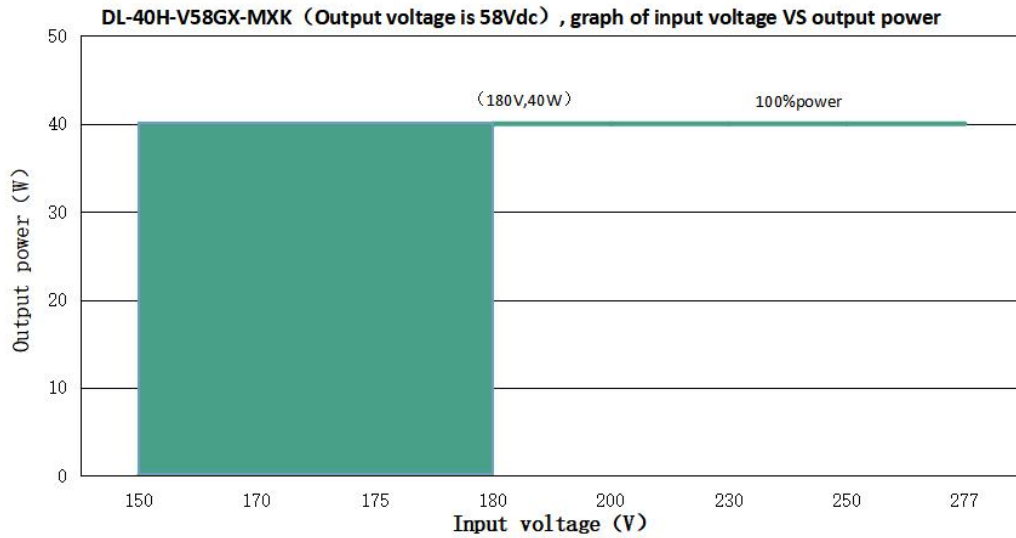

DL-40H-V58GX-MXK (When the output voltage is 58Vdc, the rated output current value and output power corresponding to different input voltage)

Input Voltage	165Vac	170Vac	175Vac	180Vac	200Vac	230Vac	250Vac	277Vac
Iout	0A	0.7A	0.7A	0.7A	0.7A	0.7A	0.7A	0.7A
Pout	0W	40W	40W	40W	40W	40W	40W	40W

Note:

The input voltage is less than 180Vac ±10%, the Output is turned off directly.

Dimming curve

1.Logarithmic Dimming Curve

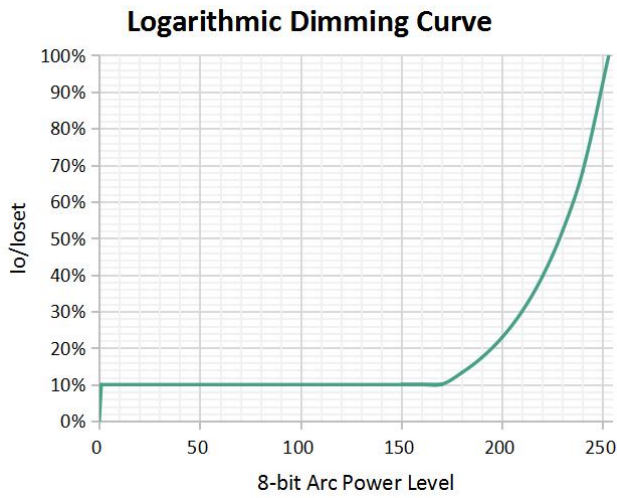

2.Linear Dimming Curve

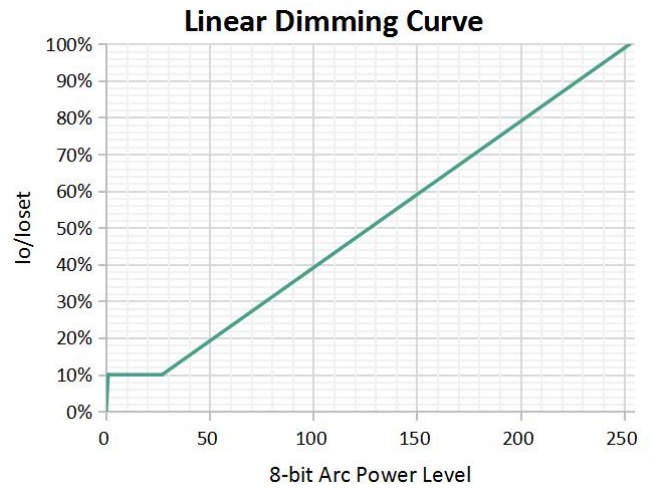

Note:

1. Factory default logarithmic dimming.

Programming connection diagram:



Mechanical specification

Size (mm) L133mm*W77mm*H33mm

DL-40H-V58GX-MXK

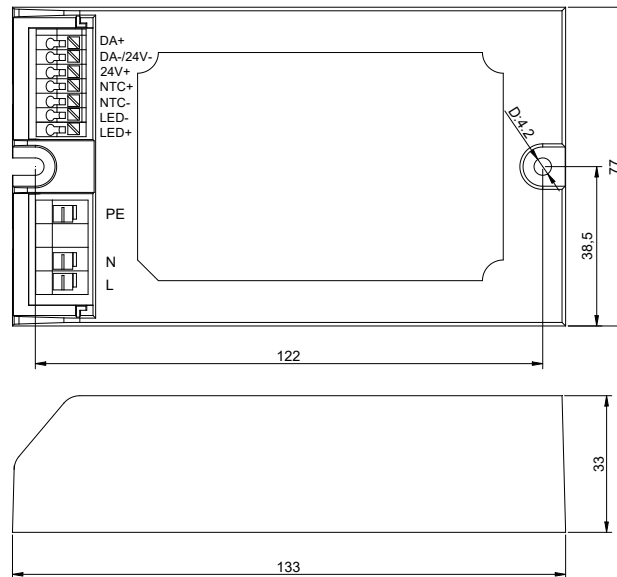

Weight

Weight 460g

Packaging

Packaging (mm) L330*W287*H206

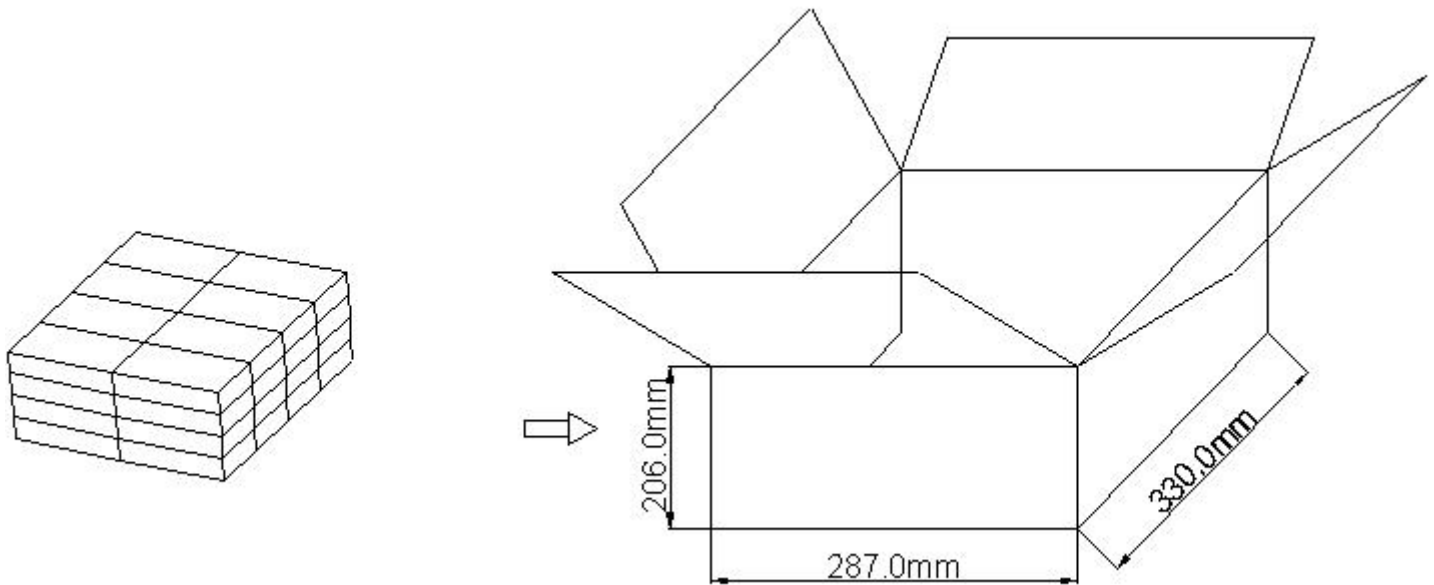

Note: One Carton 4 layers and 8 pcs each layer, total 32 pcs/carton.

Note:

1. According to the certificate obtained by the LED DRIVER, the LED DRIVER with the English label is sold in Europe, America and India.
2. The LED DRIVER with Chinese label is only used for China market.

Version

DATE	DESCRIPTION	REV.	CHECK
2024.4.29	Initial version.	E4.0	

MANUFACTURER		
EDIT	CHECK	APPROVE