 <b>GUANGDONG DONE POWER TECHNOLOGY CO.,LTD</b> <small>Service hotline: 400 0760 585 Website: www.donepower.com.cn</small>	Application	DONE WATERPROOF LED DRIVER		
	Product Line	DL-3W-MCC	REV.	1.0

## Guangdong DonePower Technology Co., Ltd.

### SPECIFICATION

CUSTOMER			
MODEL NO.	DL-3W-MCC		
VERSION	V1.0		
CUSTOMER			
TEST	CHECK	APPROVE	
CUSTOMER REMARKS			
Please return to us one copy of "SPECIFICATION FOR APPROVAL" with you approved signature.			
MANUFACTURE			
EDIT	CHECK	APPROVE	
<p>Guangdong DonePower Technology Co., Ltd.</p> <p>No. 3-1&amp;3-2, Kanglong 3rd Road, XinMao Industry Zone, Henglan Town,          Zhongshan City, Guangdong Province, P. R. China Post code: 528478</p> <p>TEL: 0760-89838399      89838379      FAX: 0760-89831157      89838396</p>			



 <b>GUANGDONG DONE POWER TECHNOLOGY CO.,LTD</b> Service hotline: 400 0760 585 Website: www.donepower.com.cn	Application	DONE WATERPROOF LED DRIVER		
	Product Line	DL-3W-MCC	REV.	1.0

## FEATURES

- ◇ Class II structure
- ◇ Input Voltage:100-240V ~ 50/60Hz
- ◇ Input 230Vac, full load output, maximum efficiency up to 80%
- ◇ PF > 0.9 & THD < 12%
- ◇ Lightning surge : differential mode L-N Class II +/- 2 KV ( 2 ohm ) 2kV refer to IEC61000-4-5 2014
- ◇ With CCC, TUV, CE, SAA certification
- ◇ Long life design , 5 years warranty
- ◇ Internal glue , level of protection : IP65

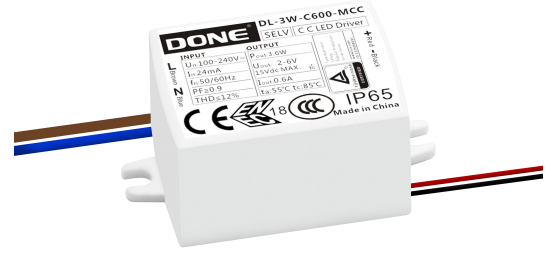

## TYPICAL APPLICATIONS

Indoor household lighting. Indoor commercial lighting.

Outdoor commercial lighting



## MODEL LIST

Model	AC Input	Output power	Output voltage	Output current	Efficiency (Typ.)	THD	PF
DL-3W-C700-MCC	100-240V 50/60Hz	4.2W	2-6Vdc	0.7A	>76%	< 12%	> 0.9
DL-3W-C600-MCC	100-240V 50/60Hz	3.6W	2-6Vdc	0.6A	>76%	< 12%	> 0.9
DL-3W-C500-MCC	100-240V 50/60Hz	3.0W	2-6Vdc	0.5A	>76%	< 12%	> 0.9
DL-3W-C350-MCC	100-240V 50/60Hz	3.9W	5-11Vdc	0.35A	>78%	< 10%	> 0.9
DL-3W-C300-MCC	100-240V 50/60Hz	3.3W	5-11Vdc	0.3A	>78%	< 12%	> 0.9
DL-3W-C270-MCC	100-240V 50/60Hz	3.0W	5-11Vdc	0.27A	>78%	< 15%	> 0.9
DL-3W-C240-MCC	100-240V 50/60Hz	2.6W	5-11Vdc	0.24A	>78%	< 15%	> 0.85
DL-3W-C210-MCC	100-240V 50/60Hz	2.3W	5-11Vdc	0.21A	>78%	< 15%	> 0.85
DL-3W-C180-MCC	100-240V 50/60Hz	2.0W	5-11Vdc	0.18A	>76%	< 15%	> 0.85
DL-3W-C150-MCC	100-240V 50/60Hz	1.7W	5-11Vdc	0.15A	>76%	< 15%	> 0.85

### Remark :

1. Default tested at 230Vac,full load with 30 minutes,Ta:25°C.

 <b>GUANGDONG DONE POWER TECHNOLOGY CO.,LTD</b> Service hotline: 400 0760 585 Website: www.donepower.com.cn	Application	DONE WATERPROOF LED DRIVER		
	Product Line	DL-3W-MCC	REV.	1.0

## ■ SPECIFICATION

### ◇ INPUT

Rated voltage	100 - 240Vac
Rated frequency	50/60Hz
Power factor(PF)	PF>0.9 @230Vac full load
Total harmonic distortion(THD)	THD<12% @230Vac full load
Input current	I <sub>in</sub> <0.06A @100Vac full load
Inrush current (Typ.)	Cold start (25°C)<30A @230Vac

### ◇ OUTPUT

Model	DL-3W-C700-MCC	DL-3W-C600-MCC	DL-3W-C500-MCC	DL-3W-C350-MCC	DL-3W-C300-MCC	DL-3W-C270-MCC	DL-3W-C240-MCC	DL-3W-C210-MCC	DL-3W-C180-MCC	DL-3W-C150-MCC
Rated current	700mA	600mA	500mA	350mA	300mA	270mA	240mA	210mA	180mA	150mA
Output voltage range	2~6Vdc	2~6Vdc	2~6Vdc	5~11Vdc	5~11Vdc	5~11Vdc	5~11Vdc	5~11Vdc	5~11Vdc	5~11Vdc
Rated output power	4.2W	3.6W	3.0W	3.9W	3.3W	3.0W	2.6W	2.3W	2.0W	1.7W
No load voltage	15V MAX.	15V MAX.	15V MAX.	20V MAX.	20V MAX.	20V MAX.	20V MAX.	20V MAX.	20V MAX.	20V MAX.
Efficiency (Typ.) @230Vac full load	>76%	>76%	>76%	>78%	>78%	>78%	>78%	>78%	>76%	>76%
Accuracy off output current	±6%									
Line regulation	±5%									
Load regulation	±5%									
Setup time	<500ms @230Vac									

 <b>GUANGDONG DONE POWER TECHNOLOGY CO.,LTD</b> Service hotline: 400 0760 585    Website: www.donepower.com.cn	Application	DONE WATERPROOF LED DRIVER		
	Product Line	DL-3W-MCC	REV.	1.0

### ◇ Protection

Over Load protection	Protection mode: hiccup restart mode, automatic recovery after removal of abnormal load conditions.
Short Circuit Protection	Doze mode, can automatically recover after abnormal conditions are removed.
Over Voltage protection	Protection mode: hiccuping or clamping in output maximum voltage ,Production undamaged,When troubleshooting,Normal operation of power supply.

#### Remarks:

1. All specifications are tested at 230Vac (50Hz) , rated load, and Ta:25°C.
2. Including setting error, linear adjustment rate and load adjustment rate.
- 3.Constant current mode operates under rated output voltage of 50%~100%, suitable for LED and other related industries

### ■ ENVIRONMENT

Working temperature	-40 ~ +55°C (Refer to "Derating Curve")
Working humidity	20 ~ 95% RH,non-condensing
Storage temperature/humidity	-30~+85°C, 10 ~ 95% RH
Resistant to vibration	10 ~ 500Hz, 5G 12min./1cycle, period for 72min. each along X, Y, Z axes
High-pot test	I/P-O/P:3.75KVAC
Insulation resistance	I/P-O/P:100M Ohms / 500VDC / 25°C/ 70% RH
MTBF	470K hrs min. MIL-HDBK-217F (Ta=25°C)

### ■ SAFETY & EMC

Safety	GB19510.1、GB19510.14、EN61347-1、EN61347-2-13、IEC61347-1、IEC61347-2-13、AS/NZS61347.1、AS/NZS61347.2.13 ; GB19510.1、GB19510.14、EN61347-1、EN61347-2-13、IEC61347-1、IEC61347-2-13、AS/NZS61347.1、AS/NZS61347.2.13 ;
EMC	EN 55015、EN 61000-3-2 、GB/T 17743、GB17625.1、 EN 61000-3-3
Surge level	difference module L-N Class II +/- 2 KV ( 2 ohm ) (IEC61000-4-5 2014)
Leakage current	<0.7mA / 230Vac

#### Remarks:

The power supply is considered as a component that will be operated in combination with final equipment. Since EMC performance will be affected by the complete installation, the final equipment manufacturers must re-qualify EMC Directive on the complete installation again.

**Vout VS PF**

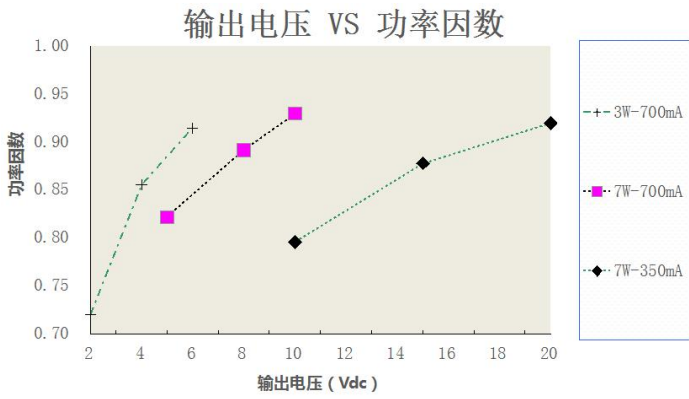

**Vout VS THD**

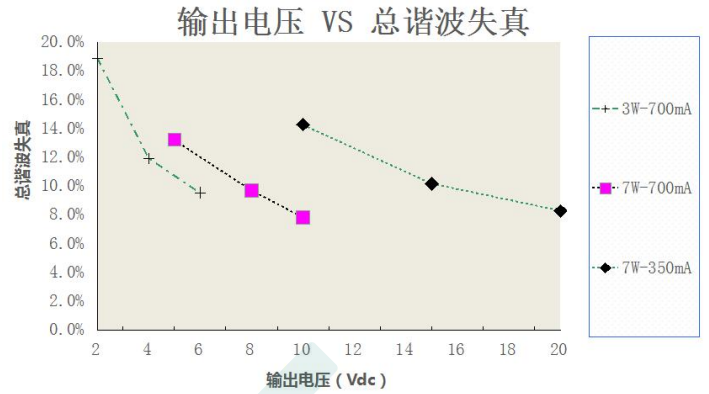

**Vout VS Efficiency**

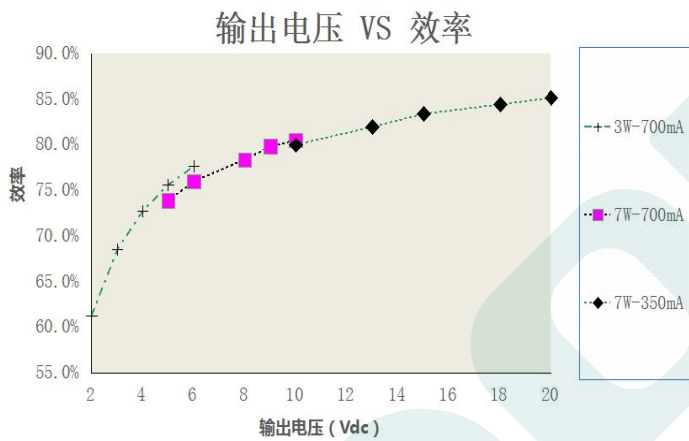

**Load reduction curve**

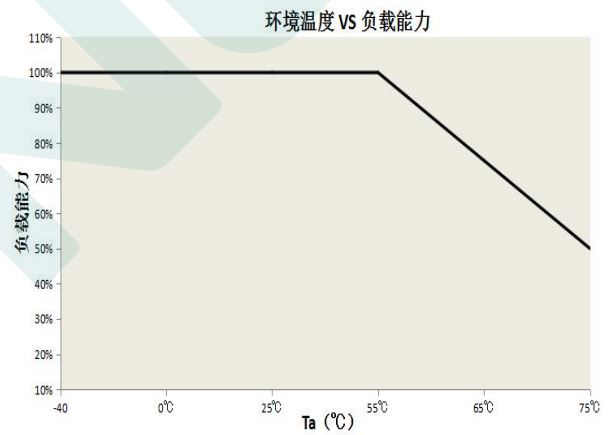

**Pout VS Vin**

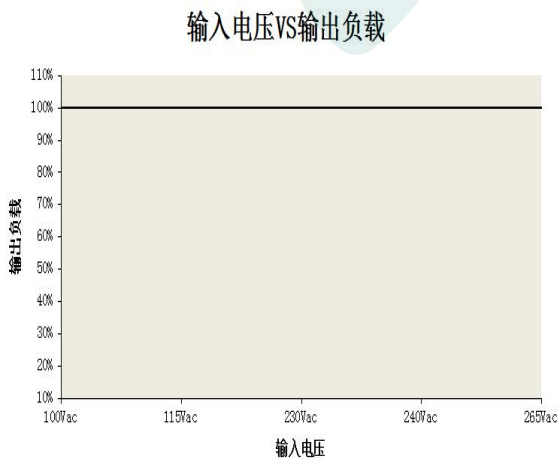

**Tc VS Life**

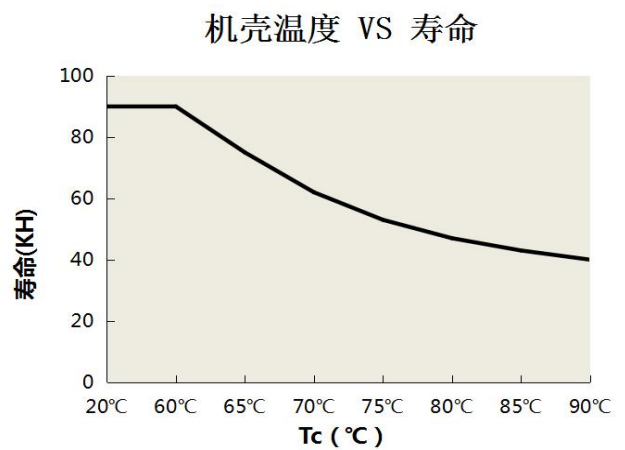

■ MACHINE SIZE MAP:

Size ( mm )	52*30*22mm
Pack	/

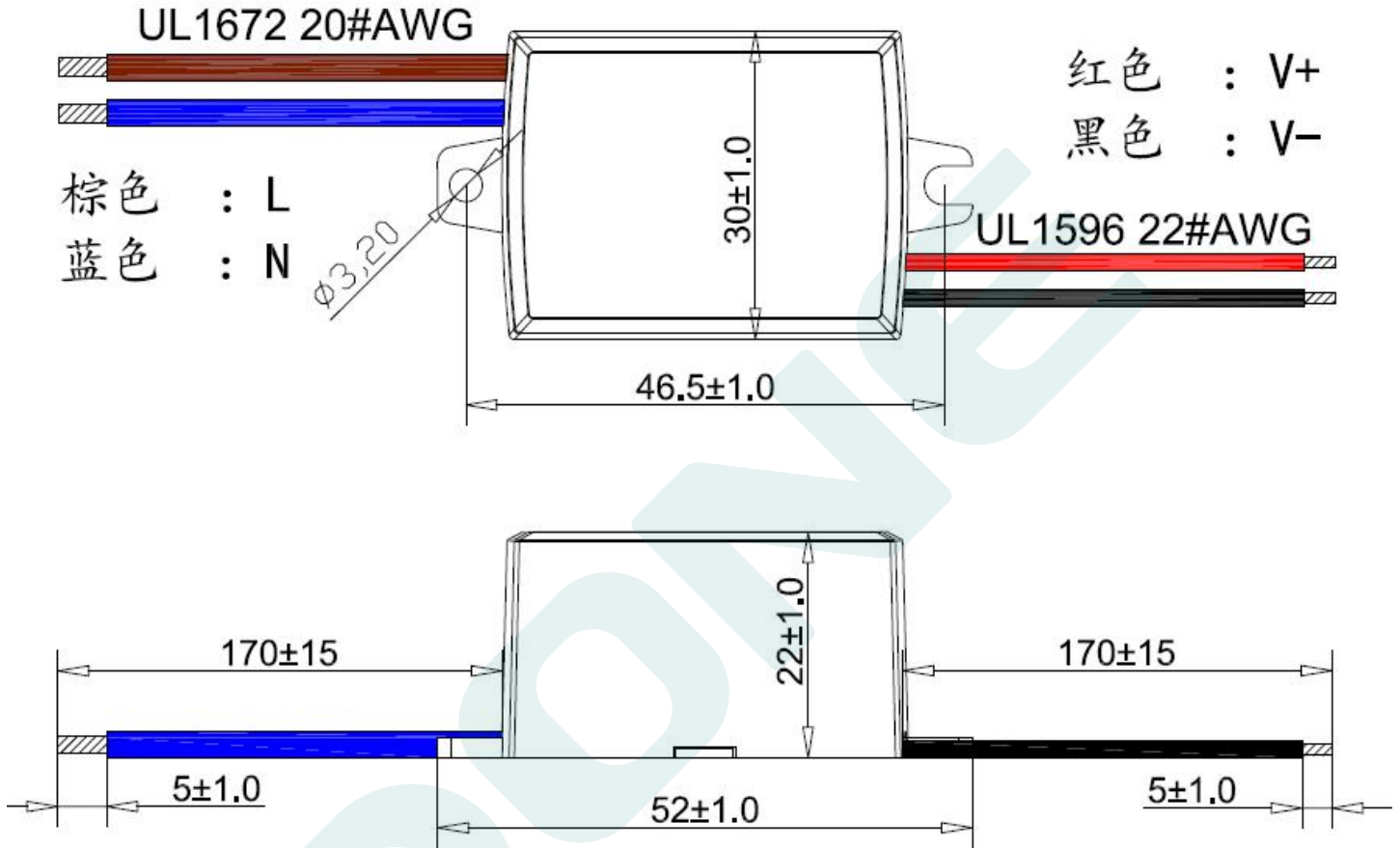

■ WEIGHT

Weight	51g
--------	-----

Warn:

1. According to the certificate obtained by the power supply, the LED DRIVER with English label is applicable to luminaires sold in Europe, America and India;
2. The LED DRIVER with Chinese label is only used for luminaires sold to China.