

# RAC SERIES LED DRIVERS

---

## DL-250H-RAC\_V1.1

Guangdong DONE Electronic Technology Co., Ltd

## Features

- Input voltage: 200-240V ~ 50/60Hz
- Efficiency :90%(Typ.)
- Constant power drive and constant voltage output control mode
- Metal shell structure
- Lightning protection level: differential mode 4KV, common mode 4KV
- All-round protection: output temperature, output over-voltage, output over-current, short circuit protection
- 3 years warranty



## Product introduction

DONE DL-250H-RAC is a series of constant voltage products with output power of 250W. DL-250H-RAC operates from 90-264Vac (Output power drops by half), and offers 12、24、36、48Vdc with different mode. The also provide perfect OTP、OVP、OLP、SCP, Product design metal rain proof structure. The aluminum shell greatly improves increases the reliability of outdoor applications. Provide reliable power supply solutions for outdoor landscape lighting, architectural lighting, and advertising sign lighting.

## Model list

Model NO.	Input voltage	Output power	Output voltage	The default current	Eff. ( Typ. )	T.H.D	PF
DL-250H-V12-RAC	200-240V 50/60Hz	200W	12Vdc	0-16.7A	≥88%	<10%	>0.97
DL-250H-V24-RAC	200-240V 50/60Hz	250W	24Vdc	0-10.4A	≥89%	<10%	>0.97
DL-250H-V36-RAC	200-240V 50/60Hz	250W	36Vdc	0-6.93A	≥90%	<10%	>0.97
DL-250H-V48-RAC	200-240V 50/60Hz	250W	48Vdc	0-5.2A	≥90%	<10%	>0.97

### Note :

1. Test conditions of the above parameters: Ta=25°C, 230Vac input, full load operation for 30 minutes;
2. Including setting error, linear adjustment rate and load adjustment rate;
3. 100 ~200Vac output current derated to 50%;

## Input characteristics

Parameter	Min	Typ.	Max	Note
Rated input voltage	200Vac 140Vdc	220Vac	240Vac 330Vdc	100 ~200Vac output current derated to 50%
Input voltage range	90Vac	-	264Vac	100 ~200Vac output current derated to 50%
Rated frequency	47Hz	50/60Hz	63Hz	N/A
Power factor	-	>0.97	-	100% load, 230Vac input
Power factor	-	>0.90	-	75% load, 230Vac input
T.H.D.	-	-	10%	100% load, 230Vac input
T.H.D.	-	-	20%	75% load, 230Vac input
Input current	-	-	1.6A	@176Vac full load
Inrush current	-	-	106A	230Vac, cold start (25°C)
16A Circuit breaker The number of power supplies of the same model can be configured	7pcs (Type C circuit breaker)13pcs (Type D circuit breaker) for 230Vac input			

## Output characteristic

Parameter	Min	Typ.	Max	Note
Rated current				
DL-250H-V12-RAC		16.7A		
DL-250H-V24-RAC	-	10.4A	-	N/A
DL-250H-V36-RAC		6.93A		
DL-250H-V48-RAC		5.2A		
Voltage regulation range				
DL-250H-V12-RAC	10.8V		13.2V	
DL-250H-V24-RAC	22.8V	-	26V	N/A
DL-250H-V36-RAC	34V		39.6V	
DL-250H-V48-RAC	46V		52.8V	
Output voltage range				
DL-250H-V12-RAC		12V		
DL-250H-V24-RAC	-	24V	-	N/A
DL-250H-V36-RAC		36V		
DL-250H-V48-RAC		48V		
Rated power(200-240Vac)	-	250W	-	DL-250H-V12-RAC Rated 200W
Rated power(100-200Vac)	-	125W	-	DL-250H-V12-RAC Rated 100W
No-load voltage				
DL-250H-V12-RAC			12.5V	
DL-250H-V24-RAC	-	-	24.5V	N/A
DL-250H-V36-RAC			36.7V	
DL-250H-V48-RAC			48.9V	
Efficiency@230Vac				
DL-250H-V12-RAC	86%	88%		
DL-250H-V24-RAC	88%	89%	-	full load @230Vac
DL-250H-V36-RAC	89%	90%		
DL-250H-V48-RAC	89%	90%		

## Output characteristic

Parameter	Min	Typ.	Max	Note
Output voltage Ripple	-	<3%	-	100% load
Accuracy of output voltage	-2%	-	+2%	100% load
Line regulation	-2%	-	+2%	50-100% load@230Vac
Load regulation	-2%	-	+2%	50-100% load@230Vac
Starting time	-	-	470ms	Full load@230Vac

## Protection

Function	Function instructions
Output overload protection	Protection mode:hiccup mode,recovers automatically after fault condition is removed.
Output short circuit protection	Hiccup mode:recovers automatically after fault condition is removed
Over temperature protection	Self-recovery type: when the housing temperature is greater than 40°C, the output power off.
Output over-voltage protection	output voltage > works voltage 1.08-1.2 <b>times turn-off</b>
Output over-current protection	Output current >1.1-1.5 <b>times turn-off</b>

## Safety and EMC

Safety categories	Standard
Safety	GB4943.1,IEC62368-1 , EN62368-1
EMC	GB/T9254.1-2021, GB17625.1-2022 、GB/T 17743、GB17625.1 EN55032/55035
Surge protection	Differential mode L-N $\pm 4\text{KV}$ ( 2 ohm ) ,common mode L, N-PE $\pm 4\text{KV}$ ( 12 ohm ); Refer to IEC61000-4-5 2014
High-pot test	I/P-O/P:3KVac I/P-PE :2KVac O/P-PE : 0.5KVac
Insulation impedance	I/P-PE:100M $\Omega$ / 500VDC; I/P-O/P:100M $\Omega$ / 500VDC / 25°C / 70% RH
Leakage current	<0.7mA@240Vac

## Environmental

Environmental categories	Parameter
Working temperature	-40 ~ +40°C @200-240Vac , (refer to "Life Curve ")
Working humidity	20 ~ 95% RH, non condensing
Storage temperature、 humidity	--30~+80°C, 10 ~ 95% RH
Resistant to vibration	10 ~ 500Hz, 5G 12 min/cycle, X, Y, Z axis 72 min each
MTBF	230Khrs min. MIL-HDBK-217F (Ta=25°C)
Lifetime	50,000 hours @Ta $\leq$ 40°C,230Vac, 100% Load, Please refer to "Tcase VS Lifetime" section

## Inrush current

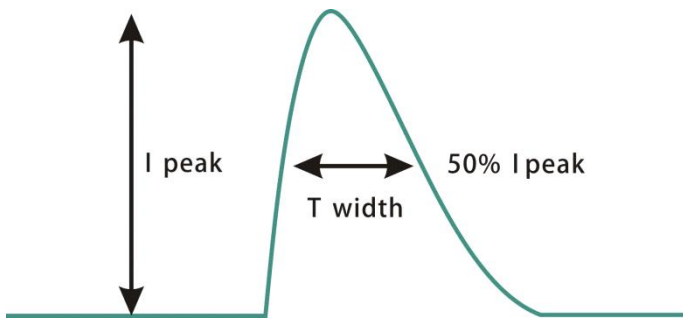

Input voltage	Peak current	T(@50% Peak current)
176Vac	76A	310us
230Vac	106A	460us
264Vac	115A	490us

## DL-250H-RAC Parametric curves

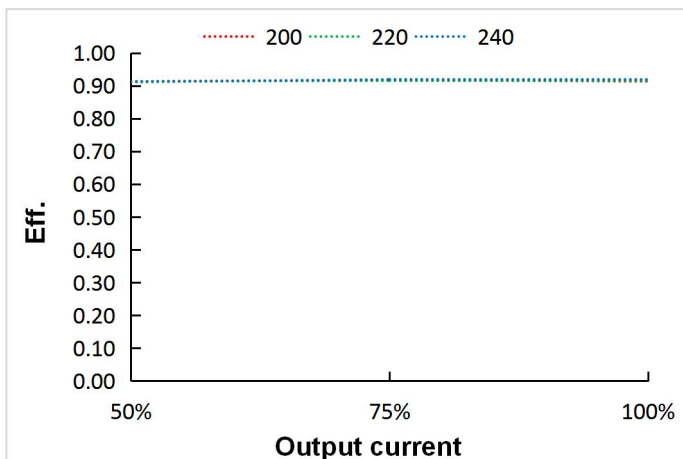

Eff. VS Output current

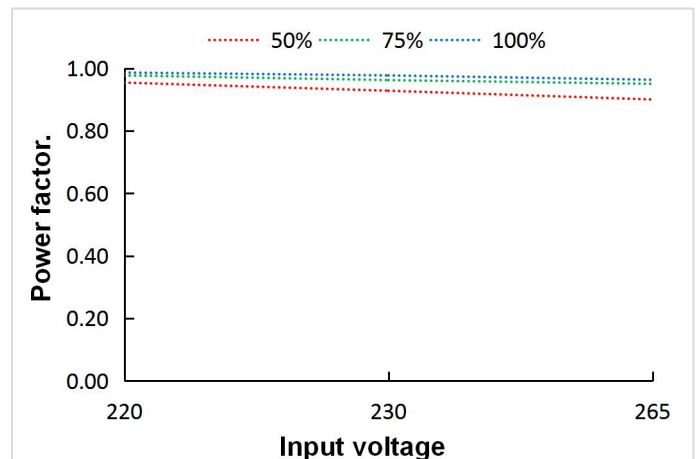

Power factor VS Input voltage

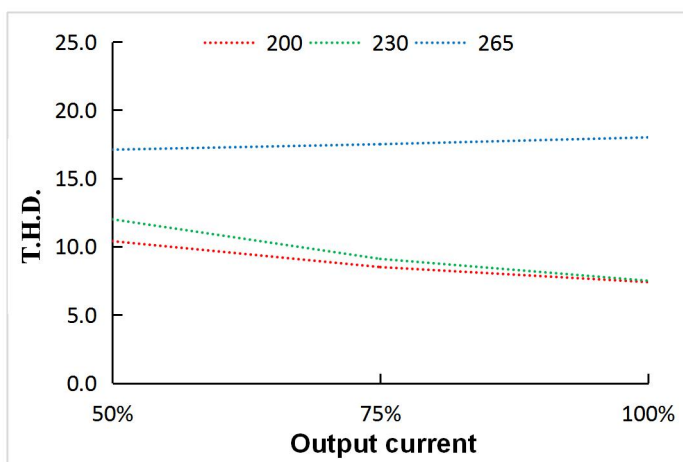

T.H.D. VS Output current

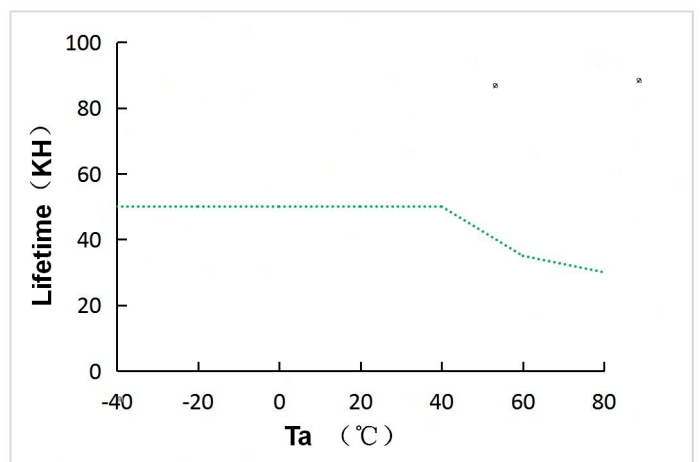

Lifetime VS Ta

**DL-250H-RAC Parametric curves**

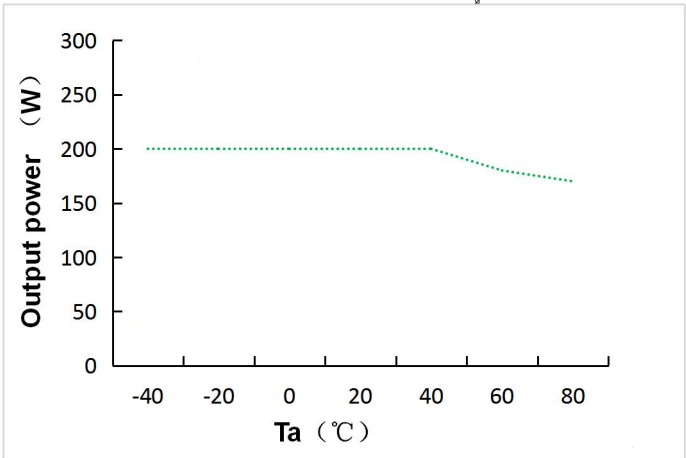

**Output power VS Ta (V12)**

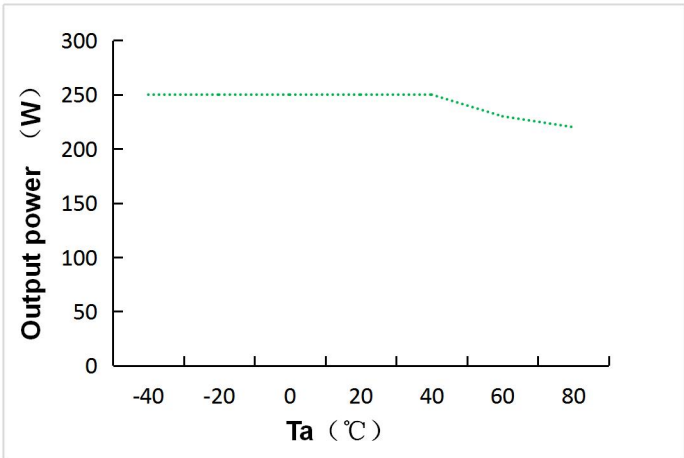

**Output power VS Ta (V24 V36 V48)**

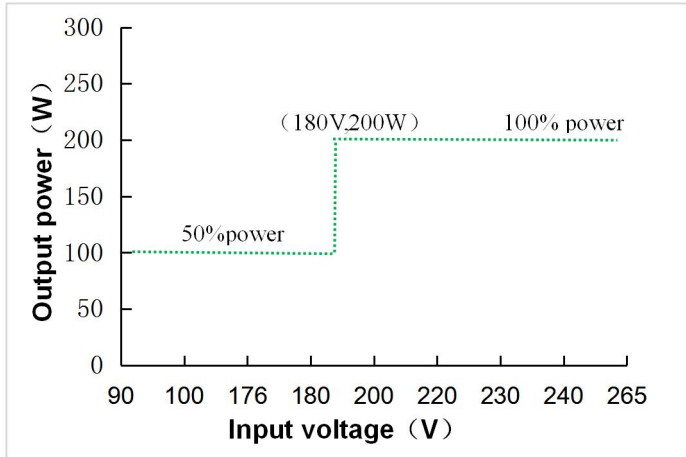

**Output power VS Input voltage(V12)**

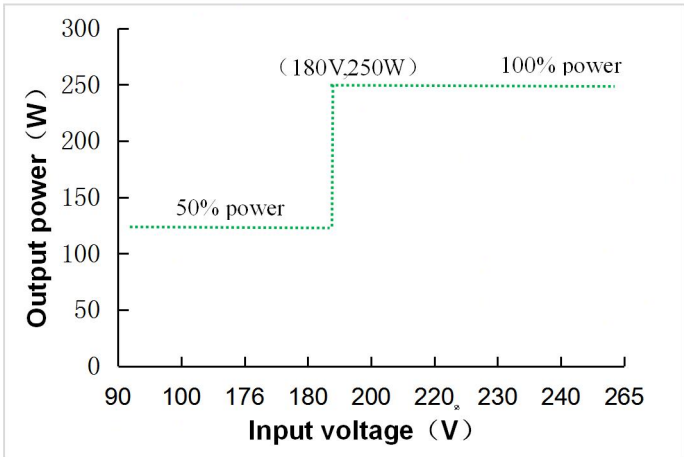

**Output power VS Input voltage(V24 V36 V48)**

**Note:** If the input voltage is lower than 90Vac, the output power off.

### Mechanical specification

Size (mm)	L200mmxW120mmxH41mm	0.82KG
-----------	---------------------	--------

#### DL-250H-RAC

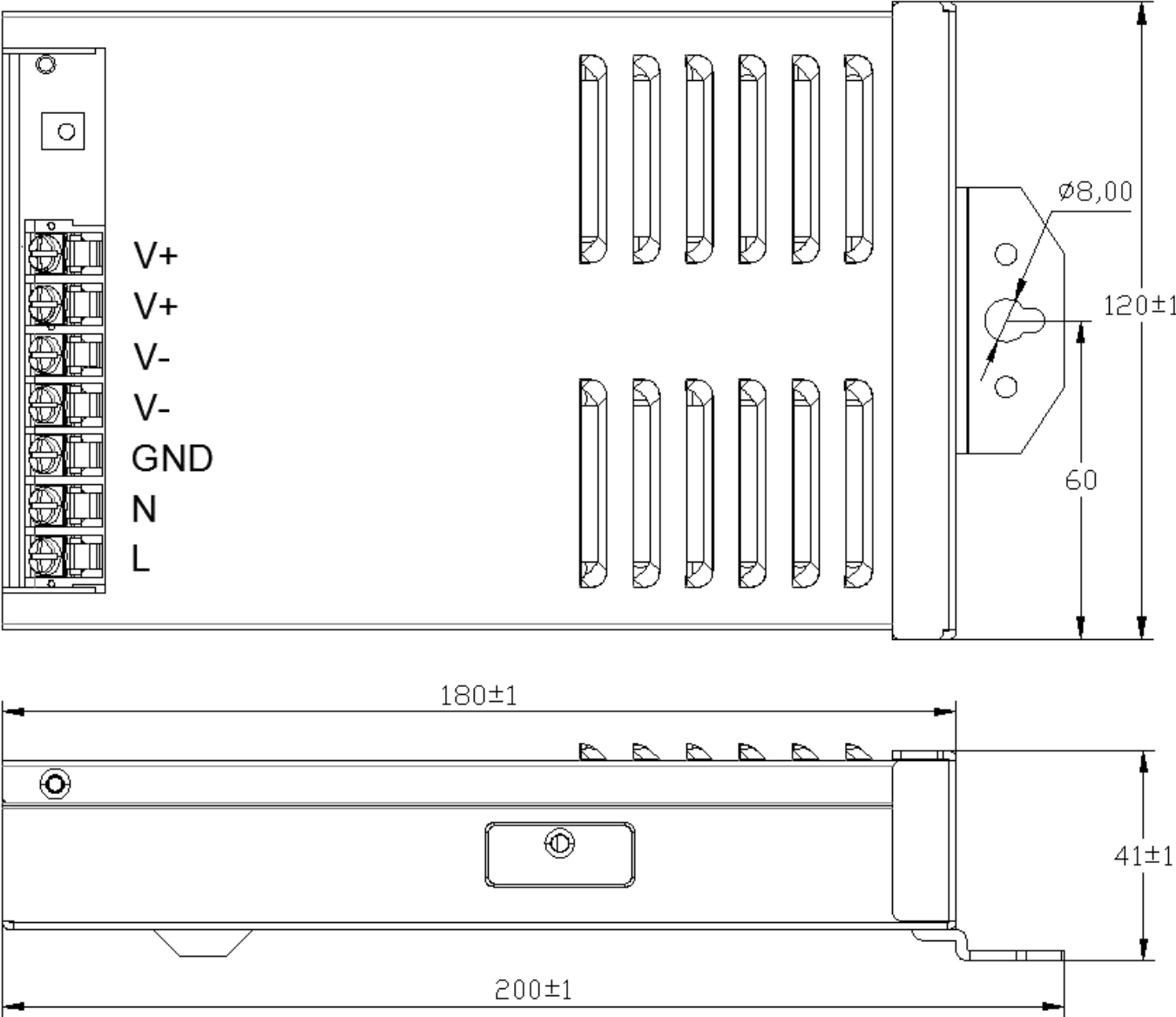

### Installation drawing

- 1. DL-250H-RAC is an outdoor design, please install in a sheltered area
- 2. The DL-250H-RAC is suitable for vertical wall-mounted mounting. Leaning forward, recline or horizontal is not allowed

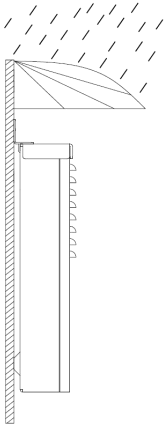

Proper installation

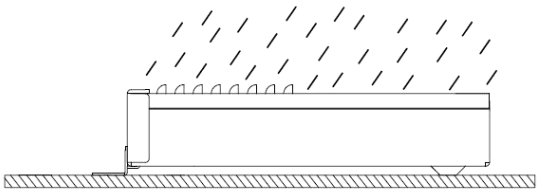

Incorrect installation

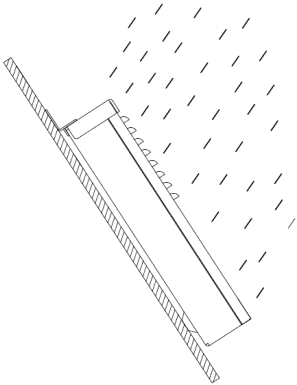

Incorrect installation

- 3. To ensure good heat dissipation, reserve enough space when selecting the installation location. The recommended installation diagram is as follows:

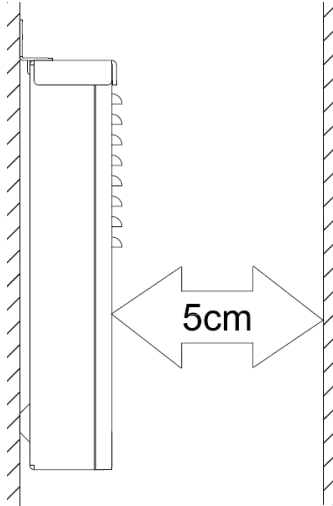
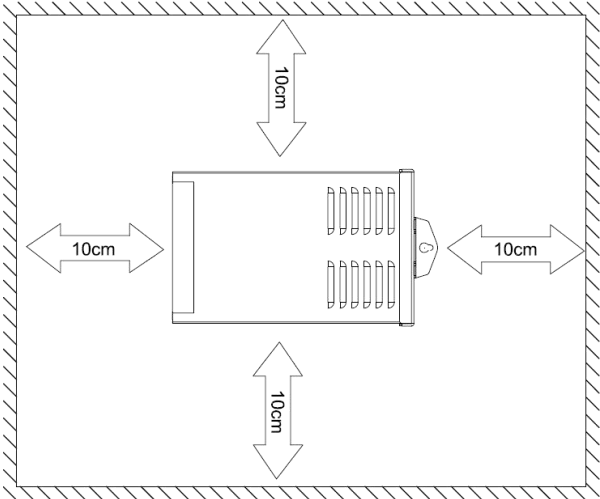

## Packaging

Packaging (mm) L422\*W252\*H187mm

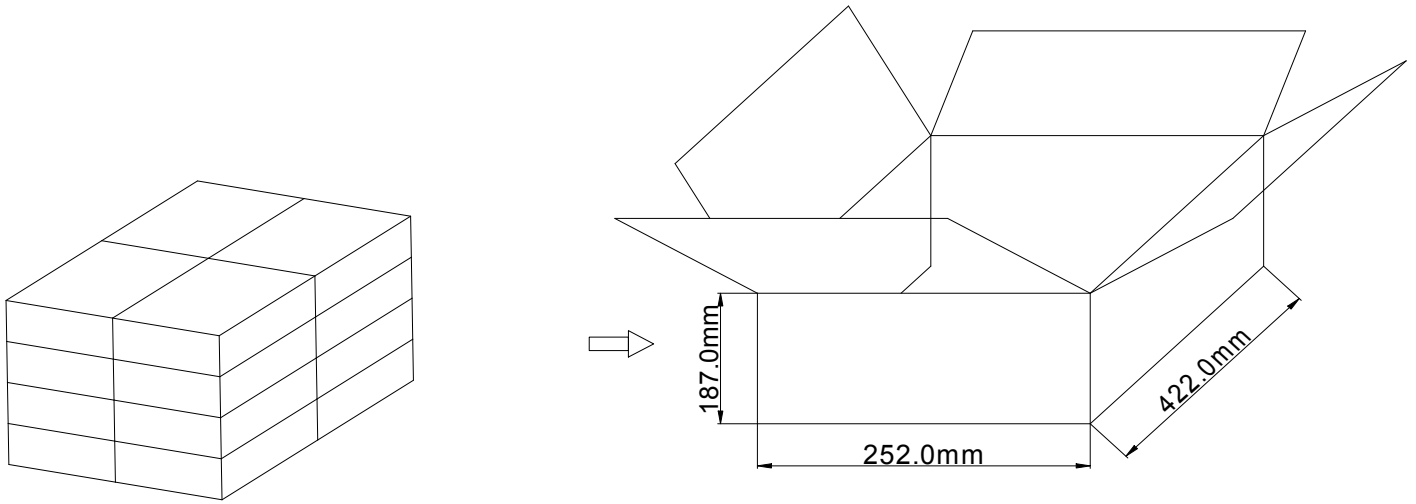

Note: One Carton 4 layers and 4pcs each layer, total 16pcs/carton.

### Note:

1. The LED DRIVER with Chinese label is only used for China market.

**Version**

DATE	DESCRIPTION	REV.	CHECK
2023.12.08	Initial version.	V1.0	
2024.03.04	V12 Parameter graph update	V1.1	

MANUFACTURER		
EDIT	CHECK	APPROVT