

RXC SERIES LED DRIVERS

DL-200H-RXC_V1.0

Guangdong DONE Electronic Technology Co., Ltd

Features

- Class I structure
- Input voltage: 200-240V ~ 50/60Hz
- Efficiency :90%(Typ.)
- Constant power drive and constant voltage output control mode
- Metal housing structure, protection grade: IP67
- Lightning protection level: differential mode 4KV, common mode 6KV
- All-round protection: output temperature, output over-voltage, output over-current, short circuit protection
- 3 years warranty



Product introduction

DONE DL-200H-RXC is a series of constant voltage products with output power of 200W. DL-200H-RXC operates from 200-240Vac, and offers 12、24、36、48Vdc with different mode .The also provide perfect OTP、OVP、OLP、SCP.and the product is designed with IP67 protection. The aluminum housing greatly improves the heat dissipation efficiency of the product and increases the reliability of outdoor applications. Provide reliable power supply solutions for outdoor landscape lighting, architectural lighting, and advertising signage lighting.

Model list

Model NO.	Input voltage	Output power	Output voltage	The default current	Eff. (Typ.)	T.H.D	PF
DL-200H-V12-RXC	200-240V 50/60Hz	200W	12Vdc	0-16.67A	≥88%	/	/
DL-200H-V24-RXC	200-240V 50/60Hz	200W	24Vdc	0-8.34A	≥89%	/	/
DL-200H-V36-RXC	200-240V 50/60Hz	200W	36Vdc	0-5.56A	≥90%	/	/
DL-200H-V48-RXC	200-240V 50/60Hz	200W	48Vdc	0-4.17A	≥90%	/	/

Note:

1. Test conditions of the above parameters: Ta=25°C, 230Vac input, full load operation for 30 minutes;
2. Including setting error, linear adjustment rate and load adjustment rate;
3. The power supply is used as a component and the terminal equipment, the EMC is affected by the whole set of devices, and the terminal equipment manufacturer needs to re-confirm the EMC of the whole set of devices.

Input characteristics

Parameter	Min	Typ.	Max	Note
Rated input voltage	200Vac 250Vdc	220Vac	240Vac 360Vdc	
Input voltage range	176Vac	-	264Vac	
Rated frequency	47Hz	50/60Hz	63Hz	N/A
Power factor	-	-	-	-
Power factor	-	-	-	-
T.H.D.	-	-	-	-
T.H.D.	-	-	-	-
Input current	-	-	2.1A	176Vac full load
Inrush current	-	-	89.6A	230Vac, cold start (25°C)
16A Circuit breaker The number of power supplies of the same model can be configured	4pcs (Type B circuit breaker) 7pcs (Type C circuit breaker) for 230Vac input			

Output characteristics

Parameter	Min	Typ.	Max	Note
Rated current DL-200H-V12-RXC DL-200H-V24-RXC DL-200H-V36-RXC DL-200H-V48-RXC	-	16.67A 8.34A 5.56A 4.17A	-	N/A
Output current range DL-200H-V12-RXC DL-200H-V24-RXC DL-200H-V36-RXC DL-200H-V48-RXC	0A	-	16.67A 8.34A 5.56A 4.17A	N/A
Voltage regulation range DL-200H-V12-RXC DL-200H-V24-RXC DL-200H-V36-RXC DL-200H-V48-RXC	-	12V 24V 36V 48V	-	N/A
Rated power(200-240Vac)	-	200W	-	N/A
Output no-load voltage DL-200H-V12-RXC DL-200H-V24-RXC DL-200H-V36-RXC DL-200H-V48-RXC	-	-	12.5V 24.5V 36.7V 48.9V	N/A
Efficiency @230Vac DL-200H-V12-RXC DL-200H-V24-RXC DL-200H-V36-RXC DL-200H-V48-RXC	87% 88% 89% 90%	88% 89% 90% 91%	-	Full load@230Vac

Output characteristics

Parameter	Min	Typ.	Max	Note
Output voltage Ripple	-	<3%	-	Full load
Accuracy of output voltage	-3%	-	+3%	Full load
Line regulation	-3%	-	+3%	50-100% load@230Vac
Load regulation	-3%	-	+3%	50-100% load@230Vac
Starting time	-	-	460ms	Full load@230Vac

Protection

Function	Function instructions
Output overload protection	Protection mode:hiccup mode,recovers automatically after fault condition is removed.
Output short circuit protection	Hiccup mode:recovers automatically after fault condition is removed
Over temperature protection	Self-recovery mode: when the housing temperature is greater than 90℃, the output power off.
Output over-current protection	Output current >1.1-1.5times turn-off

Safety and EMC

Safety categories	Standard
Safety	GB4943.1 , IEC62368-1 , EN62368-1
EMC	CQC12-045670 , GB/T 9254.1 , EN55032/55035
Surge protection	Differential mode L-N ±4KV (2 ohm) ,common mode L, N-PE± 6 KV (12 ohm); Refer to IEC61000-4-5 2014
High-pot test	I/P-O/P:3.75KVac I/P-PE :2KVac O/P-PE : 0.5KVac
Insulation impedance	I/P-PE:100MΩ / 500VDC; I/P-O/P:100MΩ / 500VDC / 25℃ / 70% RH
Leakage current	<0.7mA@240Vac

Environmental

Environmental categories	Parameter
Working temperature	-40 ~ +55℃@200-240Vac, (refer to "Life Curve ")
Working humidity	20 ~ 95% RH, non condensing
Storage temperature、 humidity	-30 ~ +80℃, 10 ~ 95% RH
Resistant to vibration	10 ~ 500Hz, 5G 12 min/cycle, X, Y, Z axis 72 min each
MTBF	230Khrs min. MIL-HDBK-217F (Ta=25℃)
Lifetime	50,000 hours, Tc≤75℃,220Vac, 100% Load, Please refer to "Tcase VS Lifetime" section

Inrush current

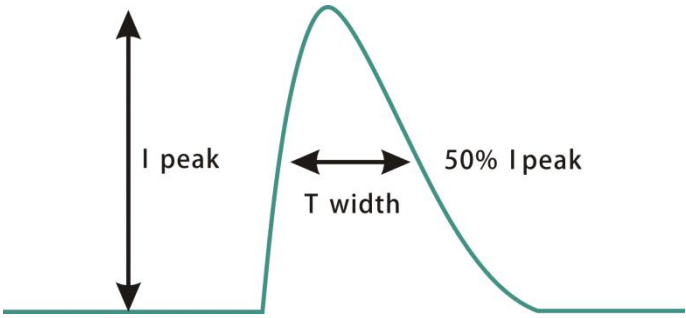

Input voltage	Peak current	T(@50% Peak current)
200Vac	89.6A	126us
220Vac	105.2A	185us
240Vac	102.6A	196us

DL-200H-RXC Parametric curves

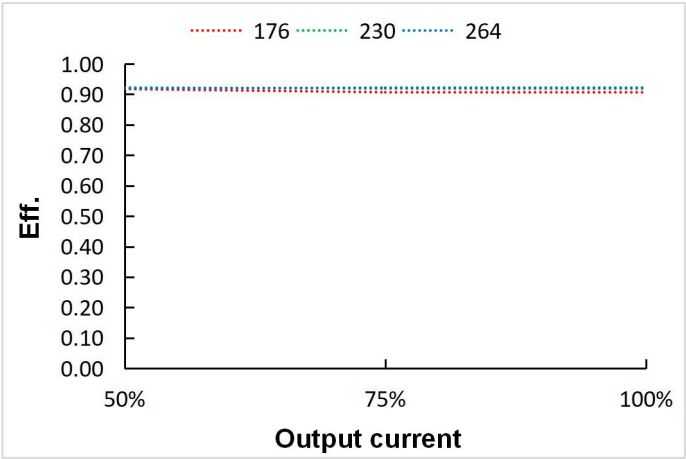

Eff. VS Output current

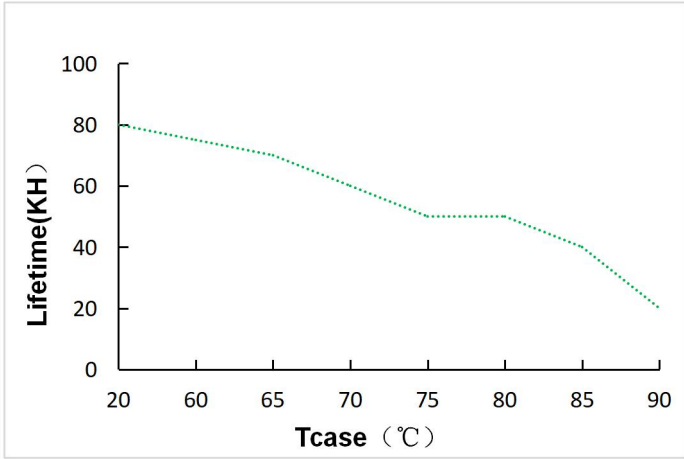

Lifetime VS Tcase

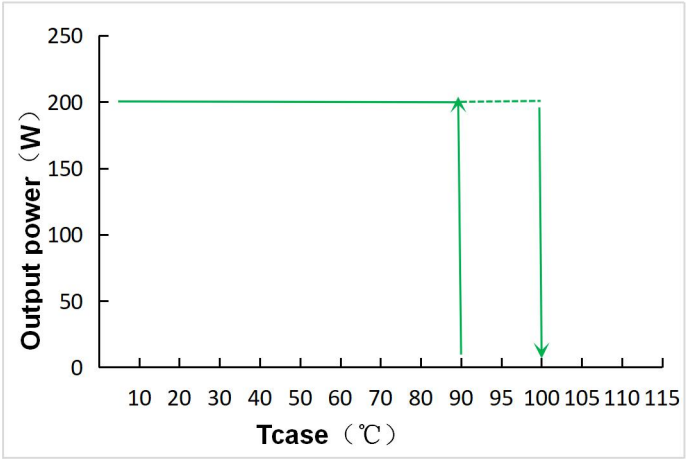

Output power VS Tcase

DL-200H-RXC Parametric curves

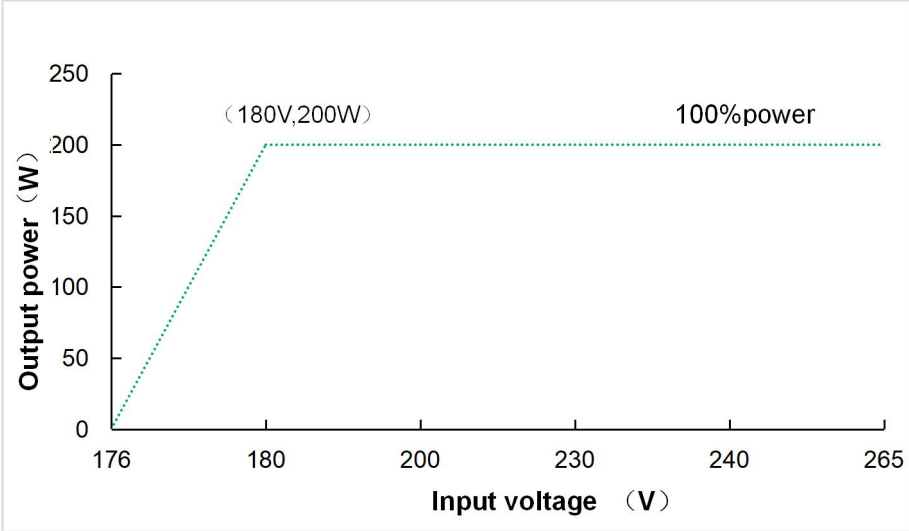

Output power VS input voltage

Note: If the input voltage is lower than 176Vac, output off.

Mechanical specification

Size (mm)	L199mm*W63mm*H37mm	0.875KG
-----------	--------------------	---------

DL-200H-V24/V36/V48-RXC

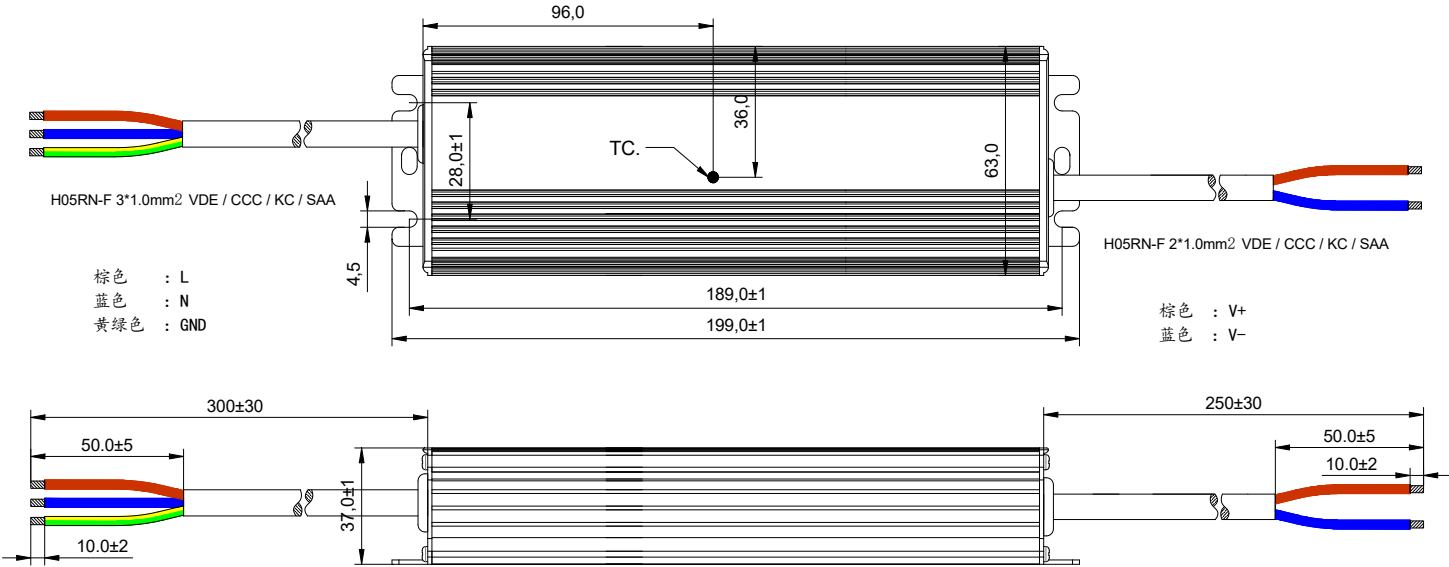

DL-200H-V12-RXC

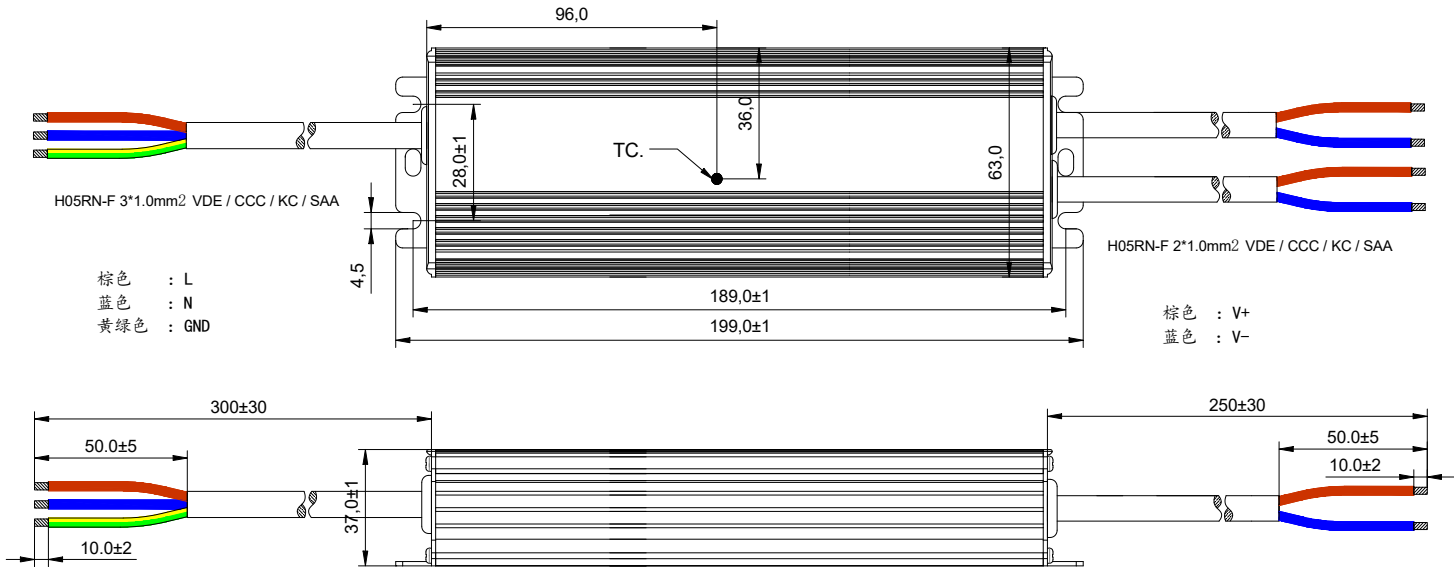

Packaging

Packaging (mm) L475*W350*H160mm

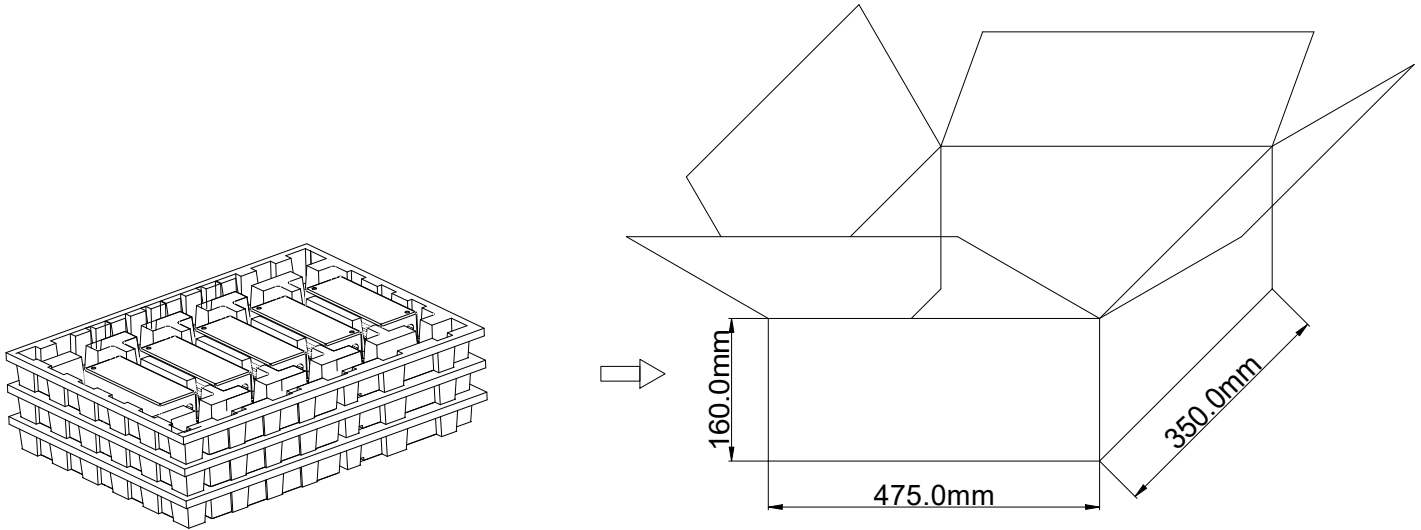

Note: One Carton 3 layers and 5pcs each layer, total 15pcs/carton.

- Note:**
1. The LED DRIVER with Chinese label is only used for China market.
 2. According to the certificate obtained by the LED DRIVER, the LED DRIVER with an English label is sold in Europe, the United States and India.

Version

DATE	DESCRIPTION	REV.	CHECK
2024.03.04	Initial version.	V1.0	

MANUFACTURER		
EDIT	CHECK	APPROVE