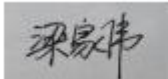

 广东东菱电源科技有限公司 Guangdong DonePower Technology Co.,Ltd 广东省中山市横栏镇康龙三路3号东菱工业园 咨询热线: 400-0760-585 WWW.DONEPOWER.COM.CN	产品类型	LED 室内驱动电源	LED INTEGRATED SPECIAL DRIVER	
	产品系列	DL-12H-LAN	REV	1.2

广东东菱电源科技有限公司

客户承认书

Guangdong Done Power Technology Co.,Ltd.

SPECIFICATION

CUSTOMER :			
MODEL NO. :	DL-12H-LAN		
VERSION:	V1.2		
CUSTOMER			
TESTED BY	CHECKED BY	APPROVED BY	
Please return to us one copy of "SPECIFICATION FOR APPROVAL" with you approved signature..			
MANUFACTRUE			
MADE BY	CHECKED BY	APPROVED BY	
 2021.07.21 17:14:02 +08'00'	 2021.07.21 19:27:07 +08'00'	 数字签名者: 张鸿生 DN: cn=张鸿生, o, ou, email=978425630@qq.com, c=CN 日期: 2021.07.22 08:09:07 +08'00'	
Guangdong Done Power Technology Co.,Ltd 广东东菱电源科技有限公司 No. 3-1&3-2, Kanglong 3rd Road, XinMao Industry Zone, Henglan Town, Zhongshan City, Guangdong Province, P. R. China Post code:528478 地址: 广东省中山市横栏镇新茂工业区康龙三路 3 号之一之二 邮编: 528478 TEL:0760-89838399 89838379 FAX:0760-89831157 89838396			

FEATURES

- ◇ Constant current mode power supply
- ◇ AC input: 220-240V ~ 50/60Hz
- ◇ Fully isolated plastic case, Class II diver
- ◇ Cooling by free air convection
- ◇ PF>0.9 & THD<15% full load
- ◇ Protections: short circuit/Over voltage with non-latching
- ◇ High efficiency /High reliability
- ◇ Surge : 1 KV (2 ohm) IEC61000-4-5 2014
- ◇ CCC/TUV/CE/SAA approved
- ◇ 5 years warranty

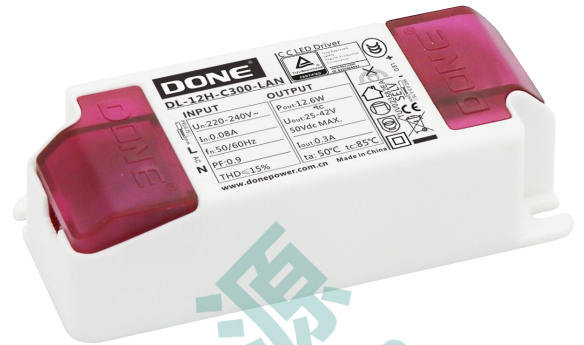

TYPICAL APPLICATIONS

Commercial lighting , Household lighting



MODEL LIST

Model	AC Input	Output voltage	Output current	Efficiency	THD	PF
				230Vac	230Vac	230Vac
DL-12H-C350-LAN	220-240Vac 50/60Hz	25~42Vdc	350mA	>84%	<15%	>0.9
DL-12H-C300-LAN	220-240Vac 50/60Hz	25~42Vdc	300mA	>84%	<15%	>0.9
DL-12H-C270-LAN	220-240Vac 50/60Hz	25~42Vdc	270mA	>83%	<15%	>0.9
DL-12H-C240-LAN	220-240Vac 50/60Hz	25~42Vdc	240mA	>83%	<15%	>0.9
DL-12H-C210-LAN	220-240Vac 50/60Hz	25~42Vdc	210mA	>82%	<15%	>0.9
DL-12H-C180-LAN	220-240Vac 50/60Hz	25~42Vdc	180mA	>81%	<15%	>0.9
DL-12H-C150-LAN	220-240Vac 50/60Hz	25~42Vdc	150mA	>79%	<15%	>0.9

Note: the test conditions of the above parameters are as follows: Ta=25 °C, 230Vac input, measured after working at full load for 30 minutes.

 广东东菱电源科技有限公司 Guangdong DonePower Technology Co., Ltd. 广东省中山市横栏镇康龙三路3号东菱工业园 咨询热线: 400-0760-585 WWW.DONEPOWER.COM.CN	产品类型	LED 室内驱动电源 LED INTEGRATED SPECIAL DRIVER		
	产品系列	DL-12H-LAN	REV	1.2

■ SPECIFICATION

◇ INPUT

Rated voltage	220 -240Vac
Voltage range	200 - 264Vac
Rated Frequency	50/60Hz
Power factor(PF)	>0.9 @230Vac full load
Total harmonic distortion(THD)	<15%@230Vac full load
Input current	0.08A @230Vac
Inrush current (typ.)	60A typ. @230Vac

◇ OUTPUT

Model	DL-12H-C350-LAN	DL-12H-C300-LAN	DL-12H-C270-LAN	DL-12H-C240-LAN	DL-12H-C210-LAN	DL-12H-C180-LAN	DL-12H-C150-LAN
Rated current	350mA	300mA	270mA	240mA	210mA	180mA	150mA
Output current range	333-377mA	285-315mA	257-283mA	228-252mA	200-220mA	168-192mA	140-160mA
Output voltage range	25-42Vdc	25-42Vdc	25-42Vdc	25-42Vdc	25-42Vdc	25-42Vdc	25-42Vdc
Rated output power	14.7W	12.6W	11.34W	10.08W	8.82W	7.56W	6.3W
No load voltage	50VdcMAX.	50VdcMAX.	50VdcMAX.	50VdcMAX.	50VdcMAX.	50VdcMAX.	50VdcMAX.
Efficiency	>84%@230Vac full load	>84%@230Vac full load	>83%@230Vac full load	>83%@230Vac full load	>82%@230Vac full load	>81%@230Vac full load	>79%@230Vac full load
Accuracy of output current	±5%	±5%	±5%	±5%	±5%	±7%	±7%
Line regulation	±5%	±5%	±5%	±5%	±5%	±5%	±5%
Load regulation	±5%	±5%	±5%	±5%	±5%	±5%	±5%
Setup time	<500ms @230Vac	<500ms @230Vac	<500ms @230Vac	<500ms @230Vac	<500ms @230Vac	<500ms @230Vac	<500ms @230Vac

◇ PROTECTION

Over load	Non-latching : Constant current limiting, recovers automatically after fault condition is removed
Short	Hiccup and non-latching, recover automatically after fault condition is removed
Over voltage	hiccup or when it is at the highest point of output voltage the product would not be hurt when the fault is excluded or is start working again the power supply is working normally

NOTE :

- 1) All parameters NOT specially mentioned are measured at 230VAC input, rated load and 25°C of ambient temperature.
- 2) Tolerance : includes set up tolerance, line regulation and load regulation.
- 3) Constant current operation region is within 50% ~100% rated output voltage. This is the suitable operation region for LED related applications.
- 4) the current accuracy of DL-12H-C150-LAN is $-7% < I_{out} < + 7%$ when the output voltage is 25-34V, and $-12% < I_{out} < + 7%$ when the output voltage is 34-42V.

■ ENVIRONMENT

WORKING TEMP.	-25 ~ +50°C (Refer to "Derating Curve")
WORKING HUMIDITY	20 ~ 95% RH, non-condensing
STORAGE TEMP, HUMIDITY	-25 ~ +80°C, 10 ~ 95% RH
VIBRATION	10 ~ 500Hz, 5G 12min./1cycle, period for 72min. each along X, Y, Z axes
WITHSTAND VOLTAGE	I/P-O/P:3.75KVAC
ISOLATION RESISTANCE	I/P-O/P:100M Ohms / 500VDC / 25°C/ 70% RH
MTBF	470K hrs min. MIL-HDBK-217F (25°C)

■ SAFETY & EMC

SAFETY	GB19510.1、GB19510.14、EN61347-1、EN61347-2-13、IEC61347-1、IEC61347-2-13、AS/NZS61347.1、AS/NZS61347.2.13 ; GB19510.1、GB19510.14、EN61347-1、EN61347-2-13、IEC61347-1、IEC61347-2-13、AS/NZS61347.1、AS/NZS61347.2.13 ;
EMC	EN 55015、EN 61000-3-2 、GB/T 17743、GB17625.1、 EN 61000-3-3
SUGER	The level of lightning surge is differential mode L-N Class II + /-1 KV (2 ohm) (IEC61000-4-5 2014)
LEAKAGE CURRENT	<0.7mA / 230Vac

NOTE :

The power supply is considered as a component that will be operated in combination with final equipment. Since EMC

performance will be affected by the complete installation, the final equipment manufacturers must re-qualify EMC Directive on the complete installation again.

OUTPUT VOLTAGE VS PF

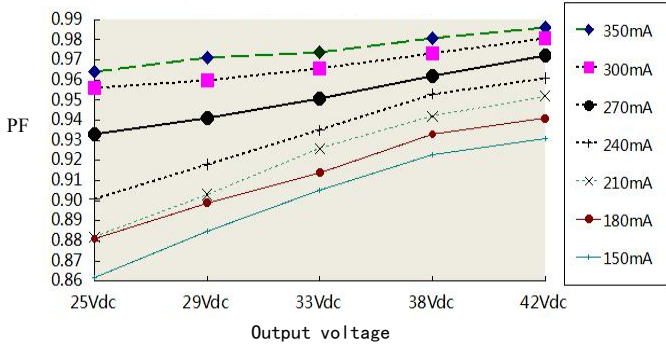

OUTPUT VOLTAGE VS THD

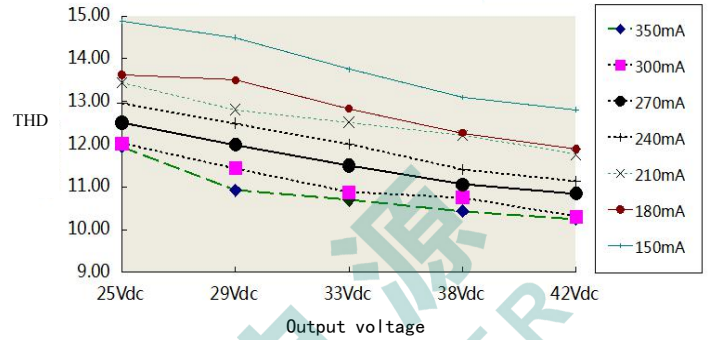

OUTPUT VOLTAGE VS EFFICIENCY

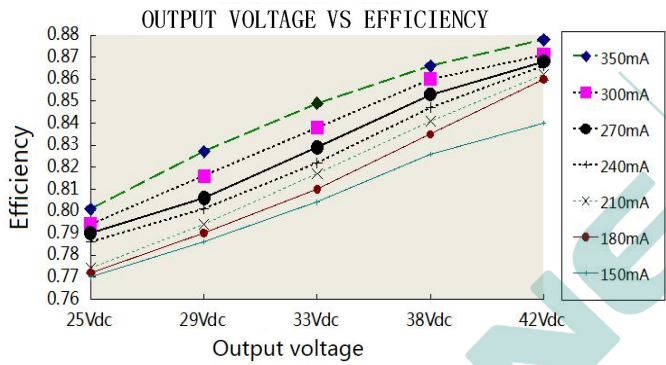

INPUT VOLTAGE VS LOAD

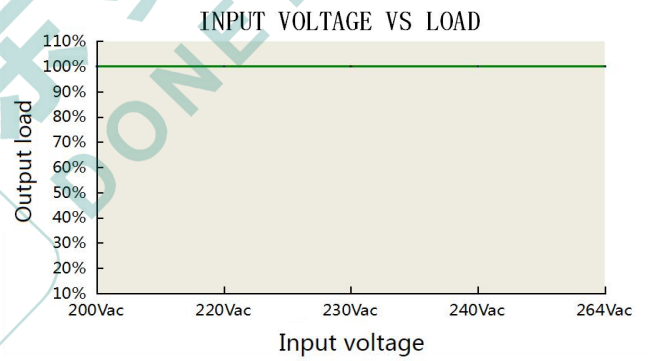

LOAD DERATING CURVE

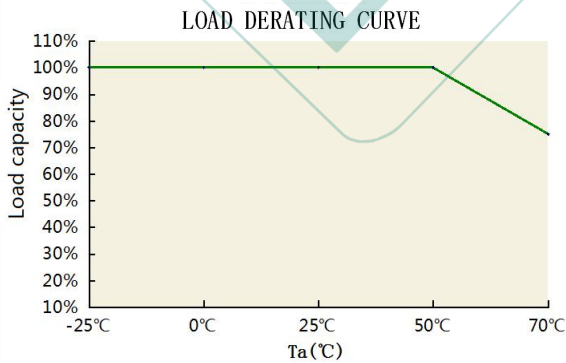

LIFE VS Tc

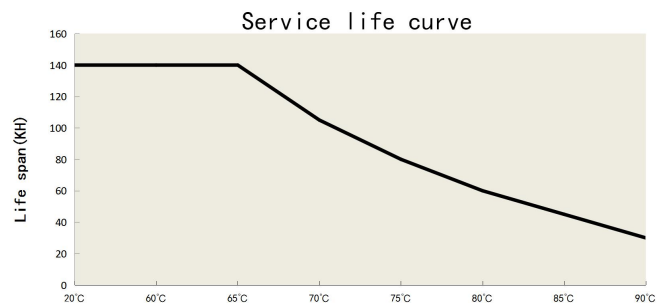

MECHANICAL SPECIFICATION & PACKING:

DIMENSION (mm)	89*38*25
PACKING	/

Case No. : FP01

Unit :mm

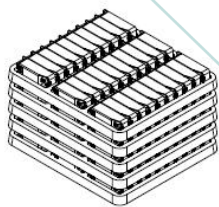
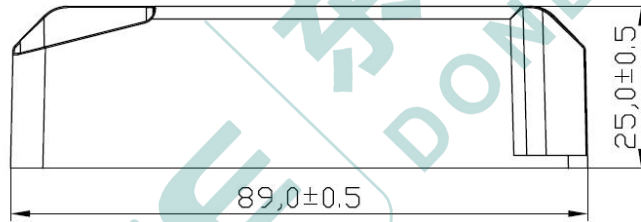
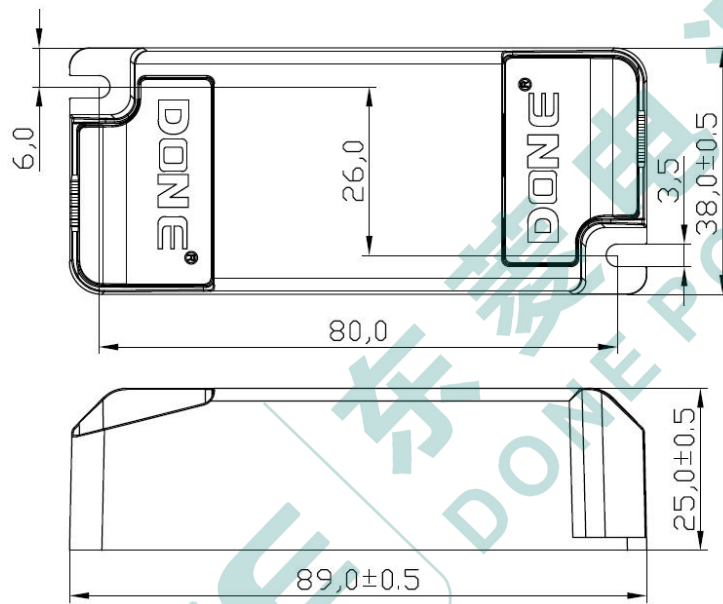

吸塑托盘
40.01.12.00005

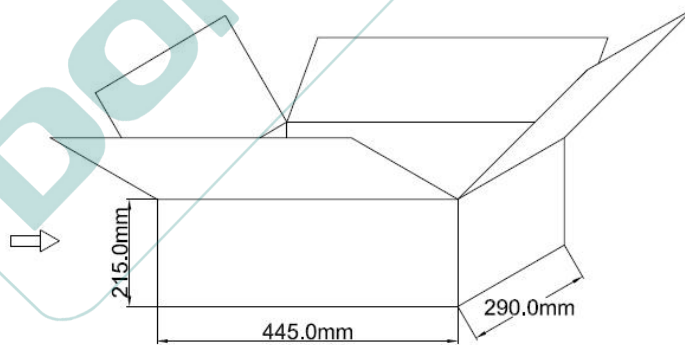

纸箱
40.01.01.00050

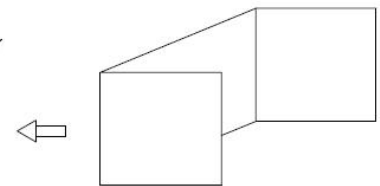

纸卡
40.01.03.00024



300PCS

塑胶堵头
20.02.06.00037

注: 一箱5层, 每层30PCS

WEIGHT

Weight	56g/PCS
--------	---------