

REVISION RECORD

REV	ECN	DESCRIPTION	DRFT	DATE
TO-2		Through the UL,UL certification parameters modification	Ethan	2016.10.21
TO-3		Design Modify	Xin	2017.12.01

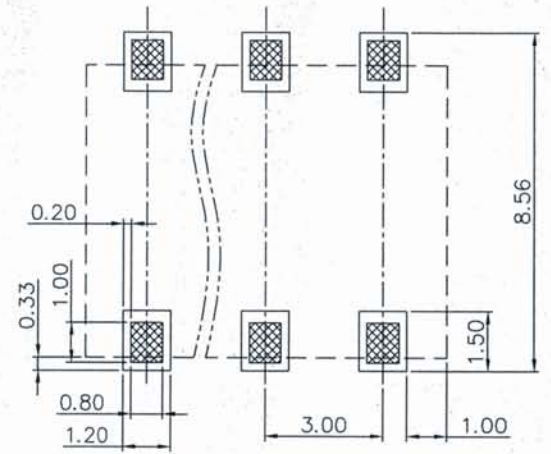

DG2001 - 3.0 - XXP - 1Y - 01A (H)  
 (Series No.)(Pitch)(Poles)(Single Pitch)(Color):1.(Grey)  
 2.(Blue) 3.(Black) 4.(Green) 5.(Orange) 6.(Red) 7.(Transparent) 8.(Yellow) 9.(White)

NOTES1:  
 UL Standard  
 1.Rated voltage/current : 600V / 3A (01P) 300V / 3A (02P,03P)  
 2.Wire range : 26~22AWG

IEC Standard

1.	3	2	2
Pollution degree	III	III	II
Overvoltage category	III	III	II
Rate impulse voltage(KV)	2.5KV	2.5KV	2.5KV
Rate voltage(V)	32V	160V	160V
Rate current(A)	3A		

2.Wire range : 0.14~0.34mm<sup>2</sup>(SOL)

NOTES2:

- 1.Dimension shall be interpreted per ASME Y14.5-2009
- 2.Pitch : 3.0mm, Poles : N=01~03P
- 3.Stripping length : 5.5~6.5mm
- 4.Operating temperature : -40°C~+130°C
- 6.Undimensioned tolerances:

Pitch range in mm	Nominal dimension range in mm						0.1/10		
	Over 6 TO 10	Over 10 TO 24	Over 30 TO 30	Over 60 TO 60	Over 100 TO 100	Over 150 TO 150			
To 6	±0.15	±0.20	±0.30	±0.30	±0.50	±0.70	±1.00	±1.30	±2'

7.RoHS Compliance

仅供参考  
 签字: [Signature]  
 日期: 12-7-17

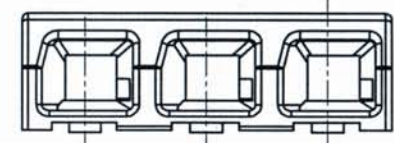
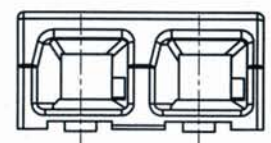
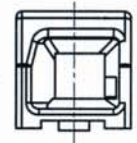
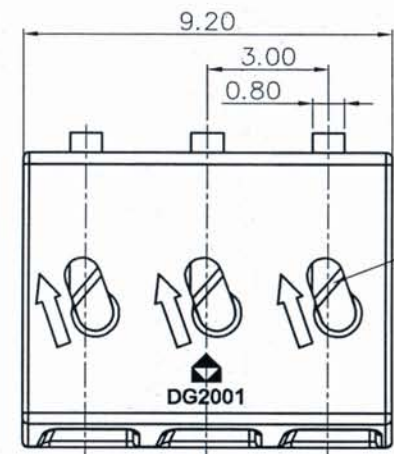
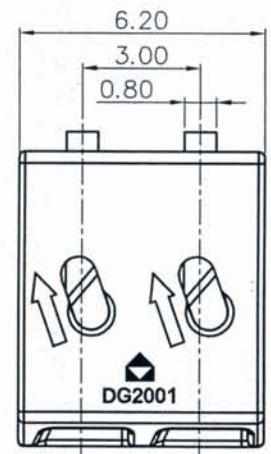
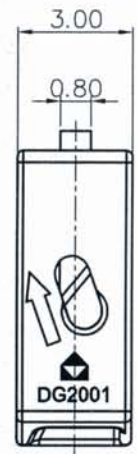

01P

02P

03P

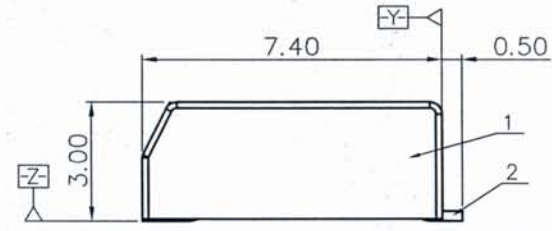

ITEM	NAME OF PART	MATERIAL	NOTES
3	Spring	Stainless steel	
2	Pin heard	Copper alloy	Sn Plated
1	Housing	LCP	UL94V-0

PART NO.: /	宁波高松电子有限公司 NINGBO DEGSON ELECTRICAL CO., LTD		
APPD: [Signature]	NAME: DG2001-3.0-XXP-1Y-01A(H)		
CHKD:	DRFT: WL 2016.05.06	TITLE: CUSTOMER DRAWING	REV: TO-3
THIRD ANGLE PROJECTION		DRAWING NO.: DG2001-3.0-C01	SHEET: 1/1
		MM (INCH)	DO NOT SCALE DRAWING
		SCALE	1:1