

CFast 3ME3

Customer: _____
Customer
Part
Number: _____
Innodisk
Part
Number: _____
Innodisk
Model Name: _____
Date: _____

Innodisk Approver	Customer Approver

**Total Solution For
Industrial Flash Storage**

Table of contents

REVISION HISTORY	4
LIST OF TABLES	5
LIST OF FIGURES	6
1. PRODUCT OVERVIEW	7
1.1 INTRODUCTION OF INNODISK CFAST 3ME3	7
1.2 PRODUCT VIEW AND MODELS	7
1.3 SATA INTERFACE	7
1.4 CFAST 2.0 FORM FACTOR	8
2. PRODUCT SPECIFICATIONS	9
2.1 CAPACITY AND DEVICE PARAMETERS	9
2.2 PERFORMANCE	9
2.3 ELECTRICAL SPECIFICATIONS	9
2.3.1 Power Requirement	9
2.3.2 Power Consumption	9
2.4 ENVIRONMENTAL SPECIFICATIONS	10
2.4.1 Temperature Ranges	10
2.4.2 Humidity	10
2.4.3 Shock and Vibration	10
2.4.4 Mean Time between Failures (MTBF)	10
2.5 CE AND FCC COMPATIBILITY	10
2.6 RoHS COMPLIANCE	11
2.7 RELIABILITY	11
2.8 TRANSFER MODE	11
2.9 PIN ASSIGNMENT	12
2.10 MECHANICAL DIMENSIONS	13
2.11 ASSEMBLY WEIGHT	13
2.12 SEEK TIME	13
2.13 HOT PLUG	13
2.14 NAND FLASH MEMORY	13
3. THEORY OF OPERATION	14
3.1 OVERVIEW	14
3.2 SATA III CONTROLLER	14
3.3 ERROR DETECTION AND CORRECTION	14
3.4 WEAR-LEVELING	15
3.5 BAD BLOCKS MANAGEMENT	15
3.6 POWER CYCLING	15
3.7 GARBAGE COLLECTION	15

4. INSTALLATION REQUIREMENTS	16
4.1 CFAST 3ME3 PIN DIRECTIONS.....	16
4.2 ELECTRICAL CONNECTIONS FOR CFAST 3ME3	16
4.3 WRITE PROTECTION (OPTIONAL).....	16
4.4 DEVICE DRIVE	16
5. SMART FEATURE SET	17
5.1 SMART ATTRIBUTES.....	17
6. PART NUMBER RULE	18
7. APPENDIX.....	19

REVISION HISTORY

Revision	Description	Date
1.0	First Released	MAY. 2015
1.1	Edit P/N rule. Edit Mechanical Dimensions	JUL. 2015
1.2	Update IOPS Update TBW	AUG. 2015
1.3	Add SMART attribute CE/FCC certification	SEP. 2015
1.4	Edit for 15nm flash	DEC. 2015
1.5	Add 16GB dual channel performance. Remove A19 performance.	April. 2016

List of Tables

TABLE 1: DEVICE PARAMETERS	9
TABLE 2: PERFORMANCE	9
TABLE 4: INNODISK CFAST 3ME3 POWER REQUIREMENT	9
TABLE 5: POWER CONSUMPTION	9
TABLE 6: TEMPERATURE RANGE FOR CFAST 3ME3	10
TABLE 7: SHOCK/VIBRATION TESTING FOR CFAST 3ME3	10
TABLE 8: CFAST 3ME3 MTBF	10
TABLE 9: CFAST 3ME3 TBW	11
TABLE 10: INNODISK CFAST 3ME3 PIN ASSIGNMENT	12
TABLE 11: SMART COMMAND	17
TABLE 12: SMART ATTRIBUTE	17

List of Figures

FIGURE 1: INNODISK CFAST 3ME3	7
FIGURE 2: INNODISK CFAST 3ME3 BLOCK DIAGRAM	14
FIGURE 3: SIGNAL SEGMENT AND POWER SEGMENT	16

1. Product Overview

1.1 Introduction of Innodisk CFast 3ME3

The Innodisk CFast 3ME3 operates at SATA III 6.0 Gb/s, which offers data transfer rate of read up to 220MB/s. and of sequential write up to 130MB/s. Compliant with CFast 2.0 standard, it is designed with 7+17 pin connector and is SATA compatible. Due to the idle power saving, it reduces 35% power consumption. CFast 3ME3 is featured as small form factor, and suitable for most industrial application.

CFast 3ME3 can work under harsh environment, and complies with ATA protocol. Without additional driver, the disk can be configured as a boot device or data storage device. CFast 3ME3 support hardware write protect to prevent modification of valuable data on a device. Besides, through Innodisk's enhanced power cycling technology and more capacitors, CFast 3ME3 prevents data loss caused by sudden power failure. By using Innodisk's iSMART, users can not only monitor the operation status of SSD, but also visualize Wear-Leveling status with graphics.

1.2 Product View and Models

Innodisk CFast 3ME3 is available in follow capacities within MLC flash ICs.

[CFast 3ME3 08GB](#)

[CFast 3ME3 64GB](#)

[CFast 3ME3 16GB](#)

[CFast 3ME3 128GB](#)

[CFast 3ME3 32GB](#)

[CFast 3ME3 256GB](#)



Figure 1: Innodisk CFast 3ME3

1.3 SATA Interface

Innodisk CFast 3ME3 supports SATA III interface, and compliant with SATA I and SATA II. SATA III interface can work with Serial Attached SCSI (SAS) host system, which is used in server computer. Innodisk CFast 3ME3 is compliant with Serial ATA Gen 1, Gen 2 and Gen 3 specification (Gen 3 supports 1.5Gbps /3.0Gbps/6.0Gbps data rate).

1.4 CFast 2.0 Form Factor

CFast 3ME3 compliant with CFast 2.0 standard, it is designed with 7+17 pin connector and is SATA compatible. CFast 2.0 leverage the same connector interface as CFast 1.1 and the SATA-3 interface for higher performance. CFast 3ME3 mechanical dimensions: 42.8mm x 36.4mm x 3.6mm.

2. Product Specifications

2.1 Capacity and Device Parameters

CFast 3ME3 device parameters are shown in Table 1.

Table 1: Device parameters

Capacity	LBA	Cylinders	Heads	Sectors	User Capacity
8GB	15649200	15525	16	63	7641MB
16GB	31277232	16383	16	63	15272MB
32GB	62533296	16383	16	63	30533MB
64GB	125045424	16383	16	63	61057MB
128GB	250069680	16383	16	63	122104MB
256GB	500118192	16383	16	63	244198MB

2.2 Performance

Burst Transfer Rate: 6.0Gbps

Table 2: Performance

Capacity	8GB	16GB		32GB	64GB	128GB	256GB
		1CH	2CH				
Sequential* Read (max.)	100 MB/s	100 MB/s	200 MB/s	200 MB/s	220 MB/s	220 MB/s	220 MB/s
Sequential* Write (max.)	20 MB/s	20 MB/s	40 MB/s	40 MB/s	80 MB/s	130 MB/s	130 MB/s
4KB Random** Read(QD32)	4000	4000	6100	6100	6900	7800	8300
4KB Random** Write(QD32)	5900	5900	8600	8600	15400	21800	21800

Note: * Sequential performance base on CrystalDiskMark 3.0.3 with file size 1000MB

**Random performance based on IO meter with Queue Depth 32

2.3 Electrical Specifications

2.3.1 Power Requirement

Table 3: Innodisk CFast 3ME3 Power Requirement

Item	Symbol	Rating	Unit
Input voltage	V _{IN}	+3.3 DC +- 5%	V

2.3.2 Power Consumption

Table 4: Power Consumption

Mode	Power Consumption (mA)
Read	220 (max.)

Write	323 (max.)
Idle	57 (max.)

2.4 Environmental Specifications

2.4.1 Temperature Ranges

Table 5: Temperature range for CFast 3ME3

Temperature	Range
Operating	Standard Grade: 0°C to +70°C
	Industrial Grade: -40°C to +85°C
Storage	-55°C to +95°C

2.4.2 Humidity

Relative Humidity: 10-95%, non-condensing

2.4.3 Shock and Vibration

Table 6: Shock/Vibration Testing for CFast 3ME3

Reliability	Test Conditions	Reference Standards
Vibration	7 Hz to 2K Hz, 20G, 3 axes	IEC 68-2-6
Mechanical Shock	Duration: 0.5ms, 1500 G, 3 axes	IEC 68-2-27

2.4.4 Mean Time between Failures (MTBF)

Table 7 summarizes the MTBF prediction results for various CFast 3ME3 configurations. The analysis was performed using a RAM Commander™ failure rate prediction.

- **Failure Rate:** The total number of failures within an item population, divided by the total number of life units expended by that population, during a particular measurement interval under stated condition.
- **Mean Time between Failures (MTBF):** A basic measure of reliability for repairable items: The mean number of life units during which all parts of the item perform within their specified limits, during a particular measurement interval under stated conditions.

Table 7: CFast 3ME3 MTBF

Product	Condition	MTBF (Hours)
Innodisk CFast 3ME3	Telcordia SR-332 GB, 25°C	>3,000,000

2.5 CE and FCC Compatibility

CFast 3ME3 conforms to CE and FCC requirements.

2.6 RoHS Compliance

CFast 3ME3 is fully compliant with RoHS directive.

2.7 Reliability

Table 8: CFast 3ME3 TBW

Parameter	Value
Read Cycles	Unlimited Read Cycles
Wear-Leveling Algorithm	Support
Bad Blocks Management	Support
Error Correct Code	Support
Thermal Sensor	Support
TBW*(Total Bytes Written)	Unit:TB
8GB	2.34
16GB	4.68
32GB	9.37
64GB	18.75
128GB	37.5
256GB	75
*Total bytes written is based on JEDEC 218. (Solid-State Drive Requirements and Endurance Test Method)	
**Lifespan is calculated by device written per day.	

2.8 Transfer Mode

CFast 3ME3 support following transfer mode:

Serial ATA III 6.0Gbps

Serial ATA II 3.0Gbps

Serial ATA I 1.5Gbps

2.9 Pin Assignment

Innodisk CFast 3ME3 uses a standard SATA pin-out. See Table 9 for CFast 3ME3 pin assignment.

Table 9: Innodisk CFast 3ME3 Pin Assignment

Name	Type	Description
S1	SGND	Ground for signal integrity
S2	A+	Differential Signal Pair A
S3	A-	
S4	SGND	Ground for signal integrity
S5	B-	Differential Signal Pair B
S6	B+	
S7	SGND	Ground for signal integrity
Key and Spacing separate signal and power segments		
P1	CDI	Card Detect In
P2	PGND	Device Ground
P3	DEVSLP	Device sleep
P4	TBD	Reserved
P5	TBD	Reserved
P6	TBD	Reserved
P7	PGND	Device Ground
P8	LED1	PHY LED (LED are lighted when P8 low active)
P9	LED2	HDDA LED (LED are lighted when P9 low active)
P10	TBD	Reserved
P11	TBD	Reserved
P12	IFDet	GND
P13	PWR	Device Power (3.3V)
P14	PWR	Device Power (3.3V)
P15	PGND	Device Ground
P16	PGND	Device Ground
P17	CDO	Card Detect Out

2.10 Mechanical Dimensions

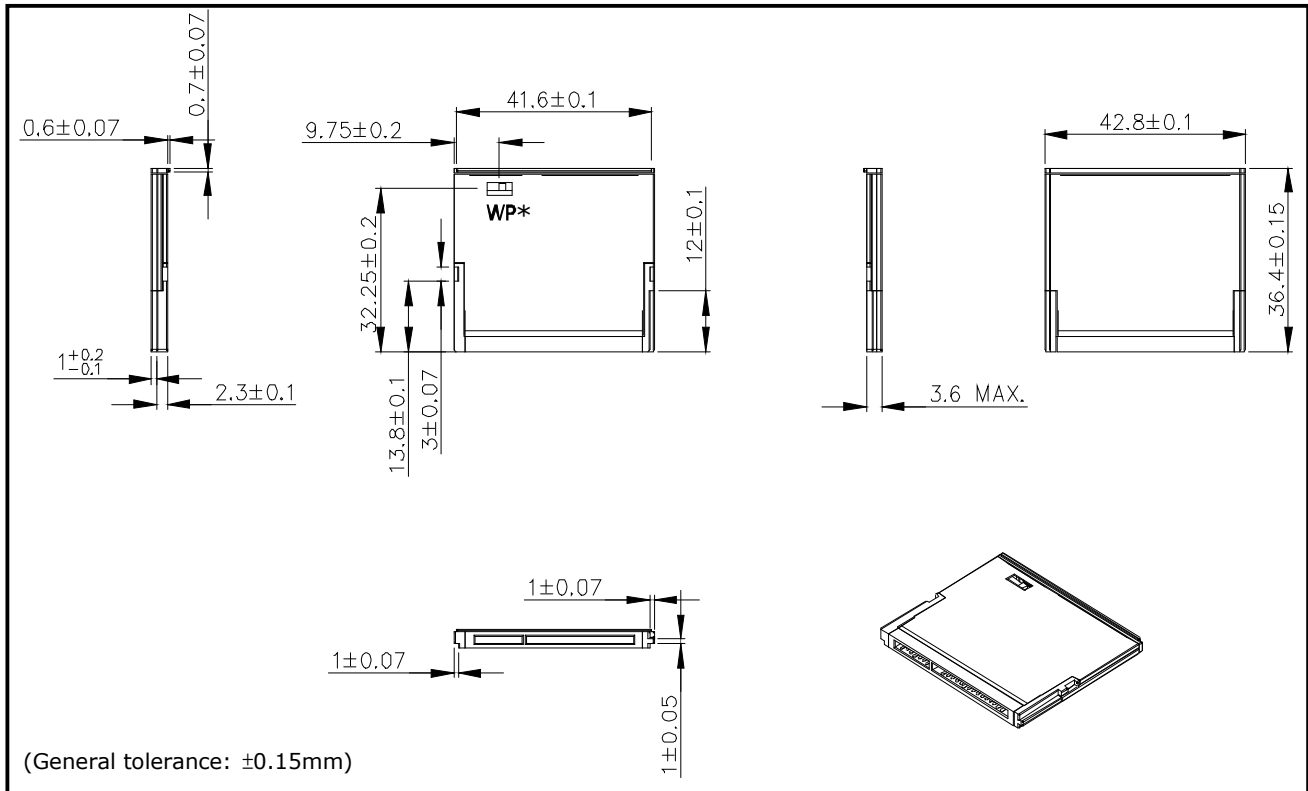

*Write Protect is optional.

2.11 Assembly Weight

An Innodisk CFast 3ME3 within MLC flash ICs, 128GB's weight is 10 grams approx. The total weight of card will be less than 15 grams.

2.12 Seek Time

Innodisk CFast 3ME3 is not a magnetic rotating design. There is no seek or rotational latency required.

2.13 Hot Plug

The card support hot plug function and can be removed or plugged-in during operation. User has to avoid hot plugging the card which is configured as boot device and installed operation system.

Surprise hot plug:

The insertion of a SATA device into a backplane (combine signal and power) that has power present. The device powers up and initiates an OOB sequence.

Surprise hot removal:

The removal of a SATA device from a powered backplane, without first being placed in a quiescent state.

2.14 NAND Flash Memory

Innodisk CFast 3ME3 uses Multi Level Cell (MLC) NAND flash memory, which is non-volatility, high reliability and high speed memory storage.

3. Theory of Operation

3.1 Overview

Figure 2 shows the operation of Innodisk CFast 3ME3 from the system level, including the major hardware blocks.

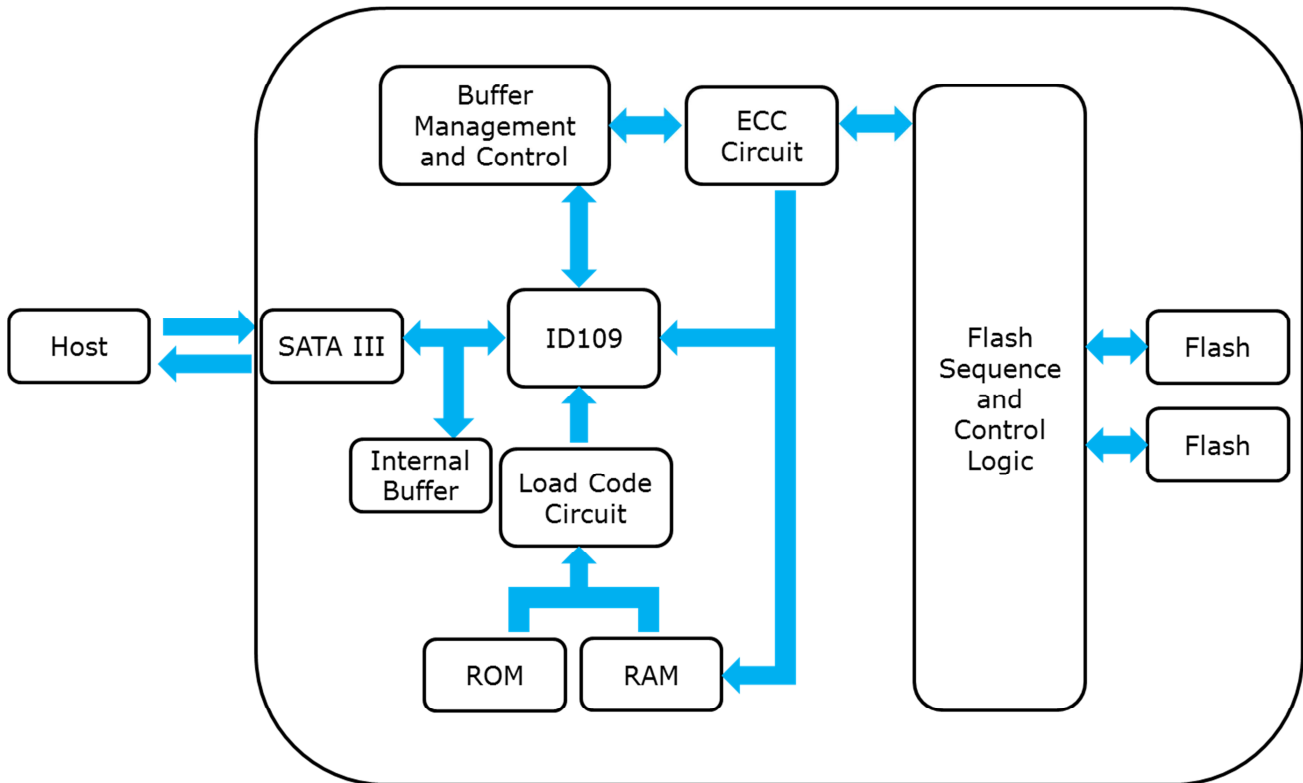

Figure 2: Innodisk CFast 3ME3 Block Diagram

Innodisk CFast 3ME3 integrates a SATA III controller and NAND flash memories. Communication with the host occurs through the host interface, using the standard ATA protocol. Communication with the flash device(s) occurs through the flash interface.

3.2 SATA III Controller

Innodisk CFast 3ME3 is designed with ID109, a SATA III 6.0Gbps (Gen. 3) controller. The Serial ATA physical, link and transport layers are compliant with Serial ATA Gen 1, Gen 2 and Gen 3 specification (Gen 3 supports 1.5Gbps/3.0Gbps/6.0Gbps data rate). The controller has 2 channels for flash interface.

3.3 Error Detection and Correction

Highly sophisticated Error Correction Code algorithms are implemented. The ECC unit consists of the Parity Unit (parity-byte generation) and the Syndrome Unit (syndrome-byte computation). This unit implements an algorithm that can correct 40 bits per 1024 bytes in an ECC block. Code-byte generation during write operations, as well as error detection during read operation, is implemented on the fly without any speed penalties.

3.4 Wear-Leveling

Flash memory can be erased within a limited number of times. This number is called the **erase cycle limit** or **write endurance limit** and is defined by the flash array vendor. The erase cycle limit applies to each individual erase block in the flash device.

Innodisk CFast 3ME3 uses a static wear-leveling algorithm to ensure that consecutive writes of a specific sector are not written physically to the same page/block in the flash. This spreads flash media usage evenly across all pages, thereby extending flash lifetime.

3.5 Bad Blocks Management

Bad Blocks are blocks that contain one or more invalid bits whose reliability are not guaranteed. The Bad Blocks may be presented while the SSD is shipped, or may develop during the life time of the SSD. When the Bad Blocks is detected, it will be flagged, and not be used anymore. The SSD implement Bad Blocks management, Bad Blocks replacement, Error Correct Code to avoid data error occurred. The functions will be enabled automatically to transfer data from Bad Blocks to spare blocks, and correct error bit.

3.6 Power Cycling

Innodisk's power cycling management is a comprehensive data protection mechanism that functions before and after a sudden power outage to SSD. Low-power detection terminates data writing before an abnormal power-off, while table-remapping after power-on deletes corrupt data and maintains data integrity. Innodisk's power cycling provides effective power cycling management, preventing data stored in flash from degrading with use.

3.7 Garbage Collection

Garbage collection technology is used to maintain data consistency and perform continual data cleansing on SSDs. It runs as a background process, freeing up valuable controller resources while sorting good data into available blocks, and deleting bad blocks.

4. Installation Requirements

4.1 CFast 3ME3 Pin Directions

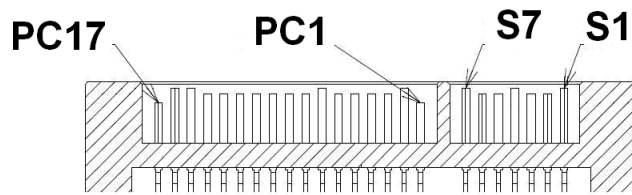

Figure 3: Signal Segment and Power Segment

4.2 Electrical Connections for CFast 3ME3

A Serial ATA device may be either directly connected to a host or connected to a host through a cable. For connection via cable, the cable should be no longer than 1 meter. The SATA interface has a separate connector for the power supply. Please refer to the pin description for further details.

4.3 Write Protection (Optional)



Innodisk CFast 3ME3 within the write-protect function could prevent the device from modification and deletion. Write-protected data could only be read, that is, users could not write to it, edit it, append data to it, or delete it. When users would like to make sure that neither themselves nor others could modify or destroy the file, users could switch on write-protection. Thus, Innodisk CFast 3ME3 could process write-protect mechanism and disable flash memory to be written-in any data. Only while the system power-off, users could switch on write-protection. Write-protection could not be switched-on, after OS booting.

4.4 Device Drive

No additional device drives are required. Innodisk CFast 3ME3 can be configured as a boot device.

5. SMART Feature Set

Innodisk 3ME3 series support the SMART command set and defines some vendor-specific data to report SMART attributes of SSD.

Table 10: SMART command

Value	Command	Value	Command
D0h	Read Data	D5h	Read Log
D1h	Read Attribute Threshold	D6h	Return Status
D2h	Enable/Disable Auto save	D8h	Enable SMART Operations
D3h	Save Attribute Values	D9h	Disable SMART Operations
D4h	Execute OFF-LINE Immediate	DAh	Return Status

5.1 SMART Attributes

Innodisk 3ME3 series SMART data attributes are listed in following table.

Table 11: SMART attribute

Attribute ID (hex)	Attribute Name
01	Read Error Rate
05	Later Bad
09	Power-On hours Count
0C	Drive Power Cycle Count
A3	Total Bad Block Count
A5	Max Erase count
A7	Avg Erase count
A9	Device Life
AA	Spare Block Count
AB	Program fail count
AC	Erase fail count
C0	Unexpected Power Loss Count
C2	Temperature
E5	Flash ID
EB	Later Bad Block
F1	Total LBAs written (each write unit = 32MB)
F2	Total LBAs read (each write unit = 32MB)

6. Part Number Rule

CODE	1	2	3	4	5	6	7	8	9	10	11	12	13	14	15	16	17	18	19	20	21
	D	E	C	F	A	-	3	2	G	D	0	9	B	C	1	D	C	X	X	X	X
Definition																					
Code 1st (Disk)											Code 13th (Flash Mode)										
D:Disk											B: Toshiba 15nm MLC										
Code 2st (Feature set)											Code 14th (Operation Temperature)										
E:Embedded series											C: Standard Grade (0°C ~ +70°C)										
											W: Industrial Grade (-40°C ~ +85°C)										
Code 3rd ~ 5th (Form Factor)											Code 15th (Internal control)										
CFA: CFast 3ME3											1~9: TSOP PCB version										
Code 7th ~9th (Capacity)											Code 16th (Channel of data transfer)										
08G: 08GB											S: Single Channel										
16G: 16GB											D: Dual Channels										
32G: 32GB																					
64G: 64GB											Code 17th (Flash Type)										
A28: 128GB											C: Toshiba MLC										
B56: 256GB																					
Code 10th ~12th (Controller)											Code 18th (Flash Type)										
D09: ID109											W: H/W Write Protect function										
											Code 19th~21th (Customized Code)										

7. Appendix

CE/FCC/RoHS/REACH

ISL International Standards Laboratory http://www.isl.com.tw

Certificate

Issue Date: August 6, 2015
Ref. Report No. ISL-15LE348CE

Product Name : CFast
Model(s) : CFast 3\$*#-&
(\$:Flash type: (S:SLC,I:iSLC,M:MLC);
*:Product line: (E:Embedded, G:EverGreen, R:InnoRobust);
#:Controller: (empty:106/107/167/170, 2:201/ 202, 3:108/109);
&:Product feature: (P:with DRAM, empty:without DRAM))

Responsible Party : Innodisk Corporation
Address : 5F.No.237, Sec. 1, Datong Rd., Xizhi Dist., New Taipei City 221, Taiwan (R.O.C.)

We, International Standards Laboratory, hereby certify that:

The device bearing the trade name and model specified above has been shown to comply with the applicable technical standards as indicated in the measurement report and was tested in accordance with the measurement procedures specified in European Council Directive- EMC Directive 2004/108/EC. The device was passed the test performed according to :



Standards:
EN 55022: 2010+AC2011 and CISPR 22: 2008 (modified)
EN 61000-3-2: 2006+A1:2009 +A2:2009 and IEC 61000-3-2: 2005+A1:2008 +A2:2009
EN 61000-3-3: 2013 and IEC 61000-3-3: 2013
EN 55024: 2010 and CISPR 24: 2010
EN 61000-4-2: 2009 and IEC 61000-4-2: 2008
EN 61000-4-3: 2006+A1: 2008 +A2: 2010 and
IEC 61000-4-3:2006+A1: 2007+A2: 2010
EN 61000-4-4:2012 and IEC 61000-4-4:2012



I attest to the accuracy of data and all measurements reported herein were performed by me or were made under my supervision and are correct to the best of my knowledge and belief. I assume full responsibility for the completeness of these measurements and vouch for the qualifications of all persons taking them.

International Standards Laboratory

Hsi-Chih LAB:
No. 65, Gu Dai Keng Street, Hsi-Chih Dist.,
New Taipei City 221, Taiwan
Tel: 886-2-2646-2550; Fax: 886-2-2646-4641



Lung-Tan LAB:
No. 120, Lane 180, Hsin Ho Rd., Lung-Tan Dist.,
Tao Yuan City 325, Taiwan
Tel: 886-3-407-1718; Fax: 886-3-407-1738

 Jim Chu / Director

International Standards Laboratory http://www.isl.com.tw

Certificate

Issue Date: August 6, 2015
Ref. Report No. ISL-15LE348FB

Product Name : CFast
Model(s) : CFast 3\$*#-&
(\$:Flash type: (S:SLC,I:iSLC,M:MLC);
*:Product line: (E:Embedded, G:EverGreen, R:InnoRobust);
#:Controller: (empty:106/107/167/170, 2:201/ 202, 3:108/109);
&:Product feature: (P:with DRAM, empty:without DRAM))
Applicant : Innodisk Corporation
Address : 5F.No.237, Sec. 1, Datong Rd., Xizhi Dist., New Taipei City 221,
Taiwan (R.O.C.)

We, **International Standards Laboratory**, hereby certify that:

The device bearing the trade name and model specified above has been shown to comply with the applicable technical standards as indicated in the measurement report and was tested in accordance with the measurement procedures specified. (refer to Test Report if any modifications were made for compliance).



Standards:

FCC CFR Title 47 Part 15 Subpart B: 2014- Section 15.107 and 15.109
ANSI C63.4-2009
Industry Canada Interference-Causing Equipment Standard ICES-003 Issue 5: 2012

Class B

I attest to the accuracy of data and all measurements reported herein were performed by me or were made under my supervision and are correct to the best of my knowledge and belief. I assume full responsibility for the completeness of these measurements and vouch for the qualifications of all persons taking them.

International Standards Laboratory

Jim Chu
Jim Chu / Director

Hsi-Chih LAB:
No. 65, Gu Dai Keng Street, Hsi-Chih Dist.,
New Taipei City 221, Taiwan
Tel: 886-2-2646-2550; Fax: 886-2-2646-4641



Lung-Tan LAB:
No. 120, Lane 180, Hsin Ho Rd., Lung-Tan Dist.,
Tao Yuan City 325, Taiwan
Tel: 886-3-407-1718; Fax: 886-3407-1738



innodisk

宜鼎國際股份有限公司
Innodisk Corporation

Tel:(02)7703-3000 Fax:(02) 7703-3555 Internet: <http://www.innodisk.com/>

REACH Declaration of Conformity

Manufacturer Product: All Innodisk EM Flash and Dram products

1.宜鼎國際股份有限公司（以下稱本公司）特此保證此售予貴公司之產品，皆符合歐盟化學品法案(Registration , Evaluation and Authorization of Chemicals ; REACH)之規定

(<http://www.echa.europa.eu/de/candidate-list-table> last updated: 16/05/2014)。所提供之產品包含：(1) 產品或產品所使用到的所有原物料；(2)包裝材料；(3)設計、生產及重工過程中所使用到的所有原物料。

We Innodisk Corporation hereby declare that our products are in compliance with the requirements according to the REACH Regulation

(<http://www.echa.europa.eu/de/candidate-list-table> last updated: 16/06/2014).

Products include : 1) Product and raw material used by the product ; 2) Packaging material ; 3) Raw material used in the process of design, production and rework

2.本公司同意因本保證書或與本保證書相關事宜有所爭議時，雙方宜友好協商，達成協議。

InnoDisk Corporation agrees that both parties shall settle any dispute arising from or in connection with this Declaration of Conformity by friendly negotiations.

立保證書人 (Guarantor)

Company name 公司名稱：InnoDisk Corporation 宜鼎國際股份有限公司

Company Representative 公司代表人：Richard Lee 李鐘亮

Company Representative Title 公司代表人職稱：CEO 執行長

Date 日期：2014 / 07 / 29



innodisk

宜鼎國際股份有限公司 Innodisk Corporation

Tel:(02)7703-3000 Fax:(02) 7703-3555 Internet: http://www.innodisk.com/

RoHS 自我宣告書(RoHS Declaration of Conformity)

Manufacturer Product: All Innodisk EM Flash and Dram products

- 一、 宜鼎國際股份有限公司（以下稱本公司）特此保證售予貴公司之所有產品，皆符合歐盟 2011/65/EU 關於 RoHS 之規範要求。

Innodisk Corporation declares that all products sold to the company, are complied with European Union RoHS Directive (2011/65/EU) requirement

- 二、 本公司同意因本保證書或與本保證書相關事宜有所爭議時，雙方宜友好協商，達成協議。

Innodisk Corporation agrees that both parties shall settle any dispute arising from or in connection with this Declaration of Conformity by friendly negotiations.

Name of hazardous substance	Limited of RoHS ppm (mg/kg)
Cd	< 100 ppm
Pb	< 1000 ppm
Hg	< 1000 ppm
Chromium VI (Cr+6)	< 1000 ppm
Polybromodiphenyl ether (PBDE)	< 1000 ppm
Polybrominated Biphenyls (PBB)	< 1000 ppm

立保證書人 (Guarantor)

Company name 公司名稱： Innodisk Corporation 宜鼎國際股份有限公司

Company Representative 公司代表人： Richard Lee 李鐘亮

Company Representative Title 公司代表人職稱： CEO 執行長

Date 日期： 2014 / 07 / 29

