

Model	Output Current	Input Current	Input Power	Output Power Range	PF	Efficiency	Output Voltage	No load Voltage
CC23W100-700 DALI DT8 NFC	100-700mA	≤0.12A	26.3W	0.38-23.10W	≥ 0.95	88%	2.5-46Vdc	60Vdc

\* Test result @230V, 50Hz, Full Load

## 1. Parameters

category	Item	Technical Norm
Features	Output Type	Constant Current
	Dimming Type	DALI-2 / Touch Dim
	Output current setting	Near field communication (NFC)
	Output Features	Isolation
	IP Grade	IP20
	Insulation Class	Class II (compatible Class I )
Input	Rated Input Voltage	220-240VAC
	Range of Input Voltage	198-264VAC
	Range of DC Input Voltage	180-280VDC
	Frequency	0/50/60Hz, Range:0/47-63Hz
	Overvoltage protection	2h@380VAC, 48h@320VAC
	Input Current	≤0.12A max
	Input Power	≤26.3W max
	Power Factor	≥0.95 (230VAC, full load)
	THD	≤11% (230VAC, full load)
	Standby Power Consumption	≤0.45W @230VAC (DALI system DIM to off )
	Inrush Current	≤7.9A/2.6us (230VAC, full load)
Connected quantity of 10A Breaker	24pcs/type A ; 39pcs/type B ; 63pcs/type C	
Connected quantity of 16A Breaker	39pcs/type A; 63pcs/type B ; 101pcs/type C	
Connected quantity of 20A Breaker	49pcs/type A; 79pcs/type B ; 126pcs/type C	

Output	Output Voltage	2.5-46VDC@100-500mA, 2.5-42VDC@550mA 2.5-38VDC@600mA, 2.5-35VDC@650mA 2.5-33VDC@700mA
	No Load Voltage (Uout)	60VDC Max.
	Output channels	2
	Output Current	100-700mA (by NFC setting ,Factory set current of 100mA)
	Max. Output Power	23.1W
	Efficiency	≥88% (230VAC, full load@max current)
	Output LF current ripple (< 120 Hz)	±3% (Imax-Imin) / (Imax+Imin )
	Current Accuracy	±5%
	Output PstLM (at full load)	≤1
	Output SVM (at full load)	≤0.4
	Starting Time ( AC mode )	≤0.8S (230VAC, full load, by DALI system)
	Starting Time ( DC mode )	≤0.4S
	Switching over time ( AC/DC )	≤0.4S
	Color tuning range	2,700-6,500K
Control Method	Secondary PUSH dimming	Secondary PUSH dimming (Max. lead wire length: 20m, same port of DALI )
	PUSH-button	Max parallel connections qty for Push-dim 15
	DALI function	DALI dimming (Max. lead wire length: 300m ) logarithm or linear dimming curve selectable
	Dimming range	DALI dimming: 1%-100%
	NFC current setting	The output current can be set within the total value range in 1-mA-steps. Output current is mean value. Setting is by KGP's software APP/APK/PC with FEIG equipment or mobile phone.
Protection	Short Circuit Protection	Auto Recovery
	Overload Protection	Auto Recovery (not be hot swap)
	No-load Protection	Auto Recovery
	Insulation voltage	3000V 5mA 60S between P-S
	Insulation resistance	>100M ohm @ 500VDC L/N to PE
	Leakage current	< 700µA, I/P to O/P @230V input
Environment	Ta/Operation Temperature	-20....+50°C
	Ts/Storage Temperature	-20....+85°C
	Tc/Enclosure Temperature	85°C
	Humidity	10%....90%RH
	Atmosphere	86-108KPa
Construction	Connection Method	Push-in Terminal
	Installation	Built -in / Independent
	PRI Wire preparation	0.5-1.5 <sup>□</sup> / 8-9mm
	SEC Wire preparation	0.5-1.5 <sup>□</sup> / 8-9mm
	DALI Wire preparation	0.5-1.5 <sup>□</sup> / 8-9mm
	Dimension	128*30*21mm (L*W*H)

Standards	Certification	CE/ENEC/SA/UKCA/EAC/CB
	Safety Standards	EN61347-1:2015/A1:2021; EN61347-2-13:2014/A1:2017; EN62384:2006/A1:2009; AS 61347.2.13:2018; AS/NZS61347.1:2016; BS EN61347-1:2015/A1:2021; BS EN61347-2-13:2014/A1:2017; IEC 61347-1:2015+A1:2017; IEC 61347-2-13:2014+A1:2016;
	EMC Standards	AS/NZS CISPR 15:2011; AS CISPR 15:2017 ; BS EN IEC 55015:2019+A11:2020; EN 61547:2009; BS EN IEC 61000-3-2:2019; BS EN 61000-3-3:2013+A1:2019;
	Performance	EN 62384
	DALI Performance	EN 62386-101 (DALI-2) EN 62386-102 (DALI-2) EN 62386-207 (DALI-2, including part 251, 252, 253)
	Surge	L/N-Ground:2kV; L-N:1kV
Others	RoHS	2011/65/EU
	Life Time	50000h Tc=85°C
		75000h Tc=80°C
		100000h Tc=75°C
Warranty	5years , F.R. < 10000ppm	

Remark: 1.All Parameters, if not specified, are measured at 230VAC/50Hz and 25°C ambient temperature.  
2.LED Driver is a component of the luminaires, Luminaires and wire layout will affect the EMC, please check the EMC with end products again.  
3.Please make sure Tc under Lifetime condition when long term operate under DC input.  
4.DC emergency (DCemDim):Default 15%, EOFx range = 1 .. 100% (EOFx = DCemDIM level)  
5.During the PUSH DIM test, the number of parallel connections must be less than 15PCS.

## 2. Label



**PRI**

KGP Electronics GmbH  
Hueckstraße 19  
DE-58511 Lüdenscheid

**LED Dimmable Driver**  
Constant Current Type for operation  
with LED modules only ● tc  
**CC23W100-700 DALI DT8 NFC**  
PRI:220-240VAC 0/50/60Hz Max. 0.12A  
SEC:100-700mA 2.5-46VDC  
U-OUT:60VDC Max. 23.1W  
PF > 0.95, ta=50°C, tc=85°C  
Current setting by NFC, step 1mA  
Range of application:DC 180-280V

wire preparation **SEC**

8-9mm

PRI: 0.5-1.5<sup>□</sup>  
DALI: 0.5-1.5<sup>□</sup>  
SEC: 0.5-1.5<sup>□</sup>

cold white channel 1

warm white channel 2







L

N

CS L — L Push-CCT

DA N — N

DA L — L Push-DIM









+

-

+

-



### 3. Dimension (Unit: mm)

Built in type:

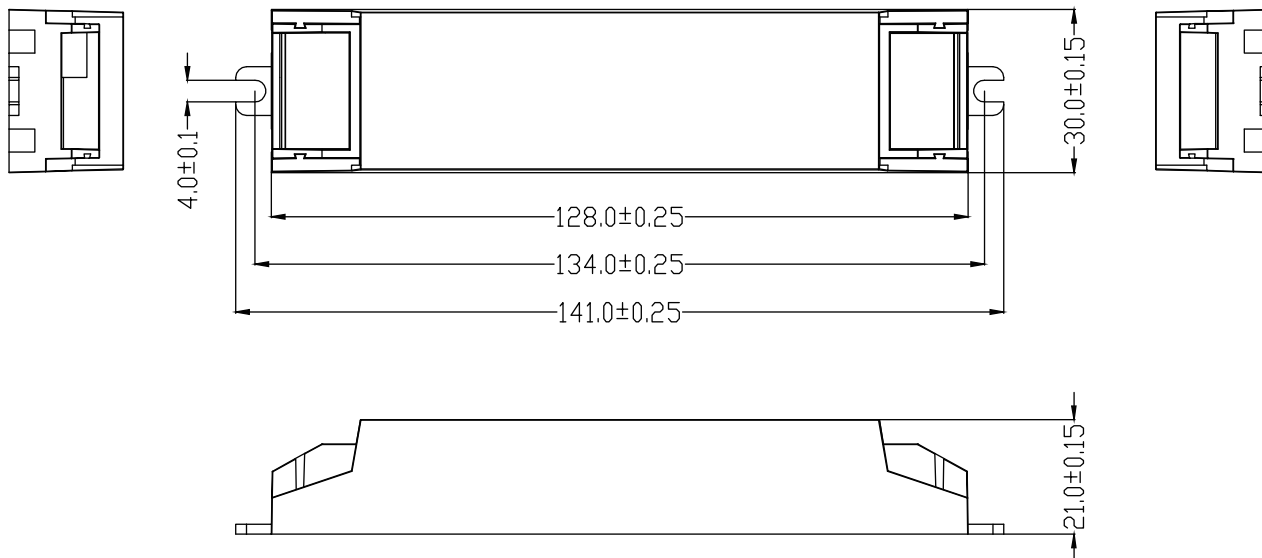

**Compatible Small Strain reliefs:SR\_CC15\_23\_36**

**Compatible Large Strain reliefs:SR\_CC15\_23\_36\_5POL**

Small Strain reliefs

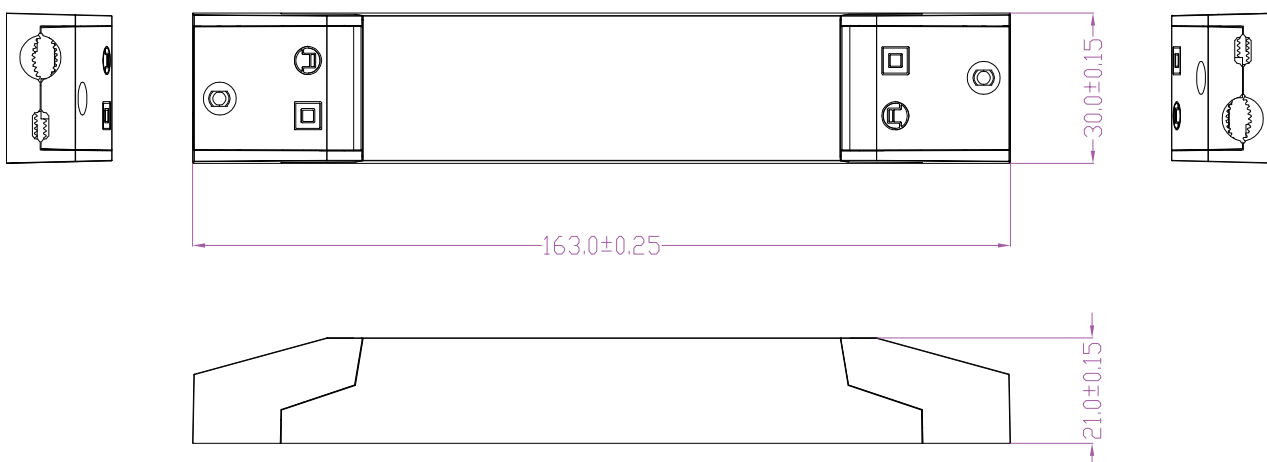

### Large Strain reliefs

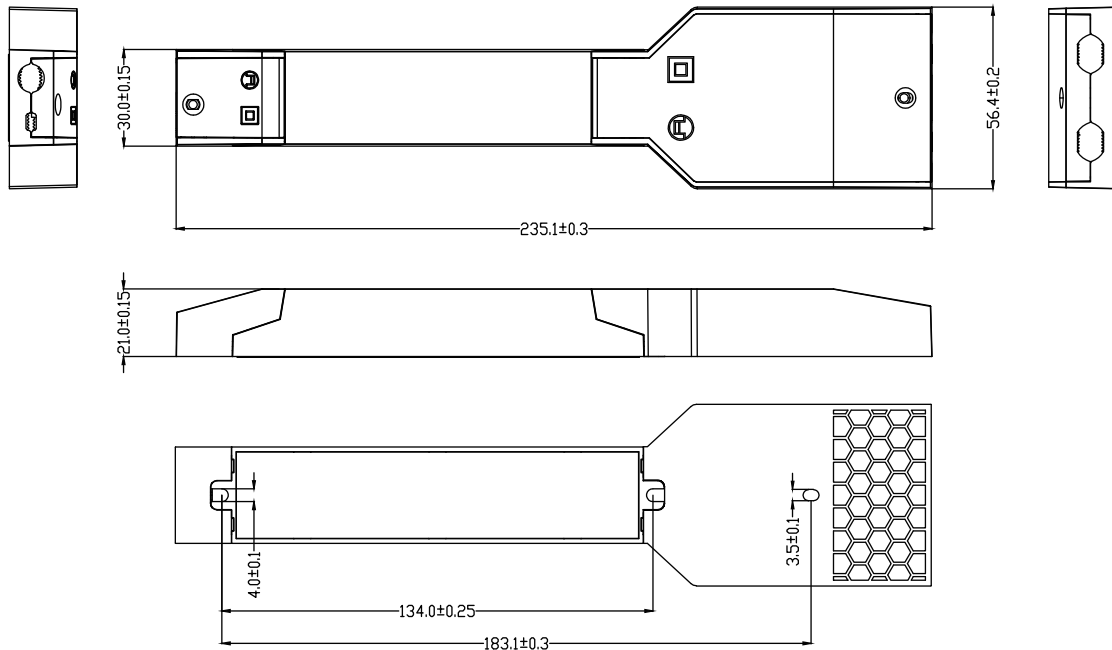

### Large Strain reliefs specifications

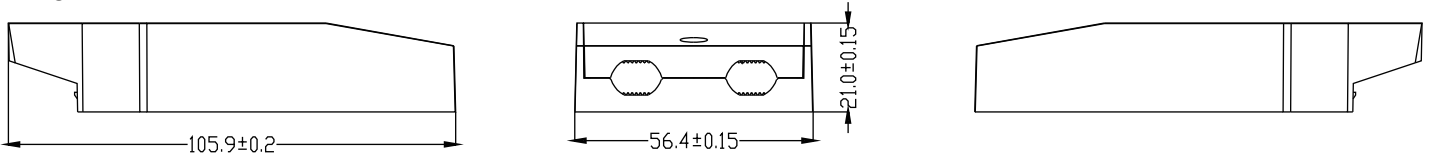

Tolerance for dimensions  $\pm 0.1$  mm

### Mechanical, Operating & Storage Conditions

Driver cross-section dimensions: 55.4-57.4 x 20.0-22.0 mm

Wire size: 0.5 - 2.5 mm<sup>2</sup>

Ambient temperature range: -20...+50 °C

Storage temperature range: -20...+85 °C

Assembly temperature range: +5...+30 °C

Do not store in wet or humid environment!

\* Unless otherwise stated in the driver datasheet (for independent installation).  
Note! Tc max temperature of the driver shall not be exceeded.

### Terminal

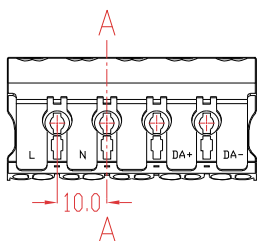

5 - pole connector for DA / CC drivers with LC-SRB-LOOP

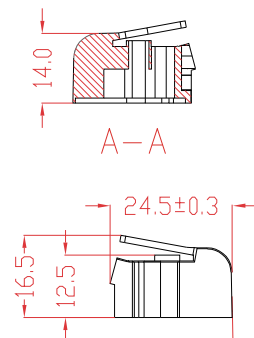
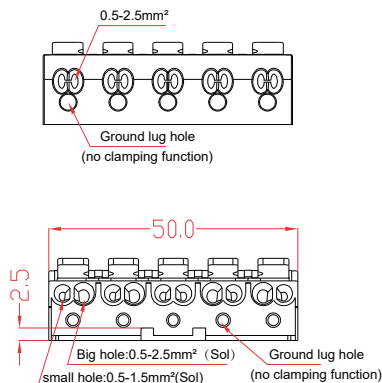

KGP Electronics GmbH  
Hueckstraße 19  
DE-58511 Lüdenscheid

### 4. Wiring Diagram

Figure: Voltage peaks for LED driver without earthing (Above) and with earthing (Below)

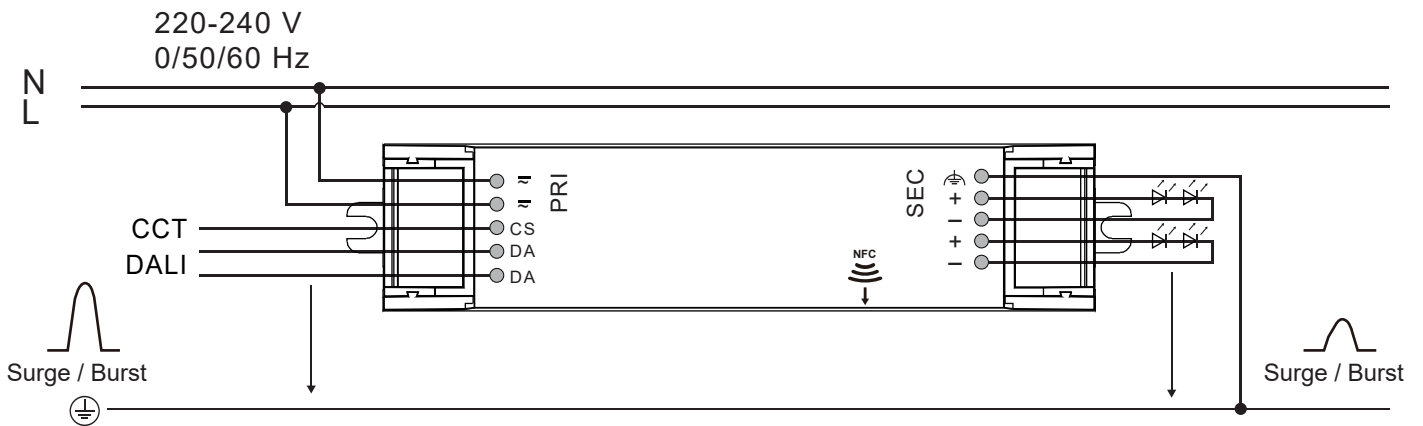
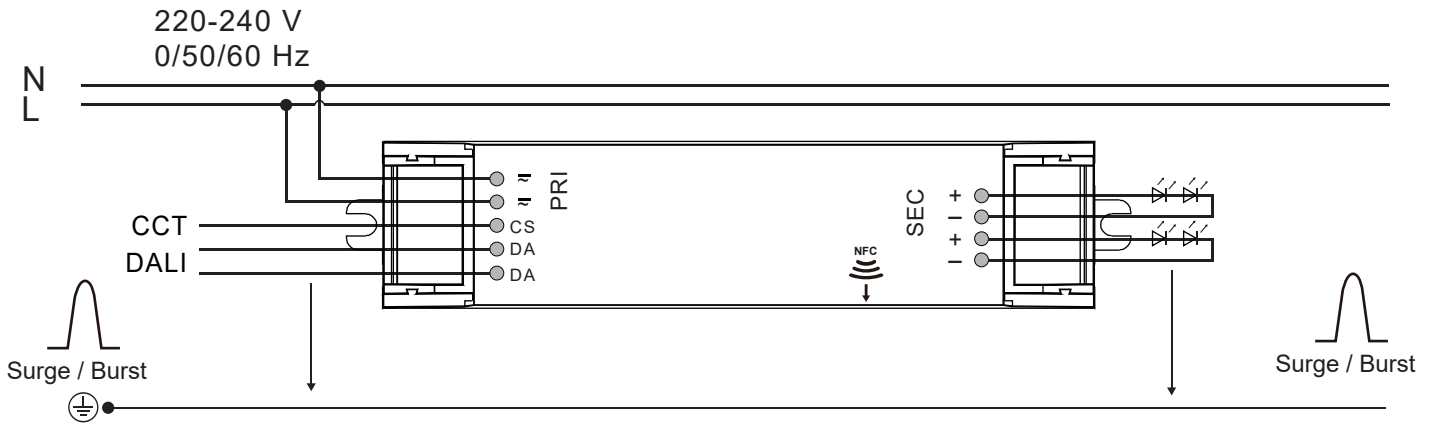

### Push Dimming

Figure: Voltage peaks for LED driver without earthing (Above) and with earthing (Below)

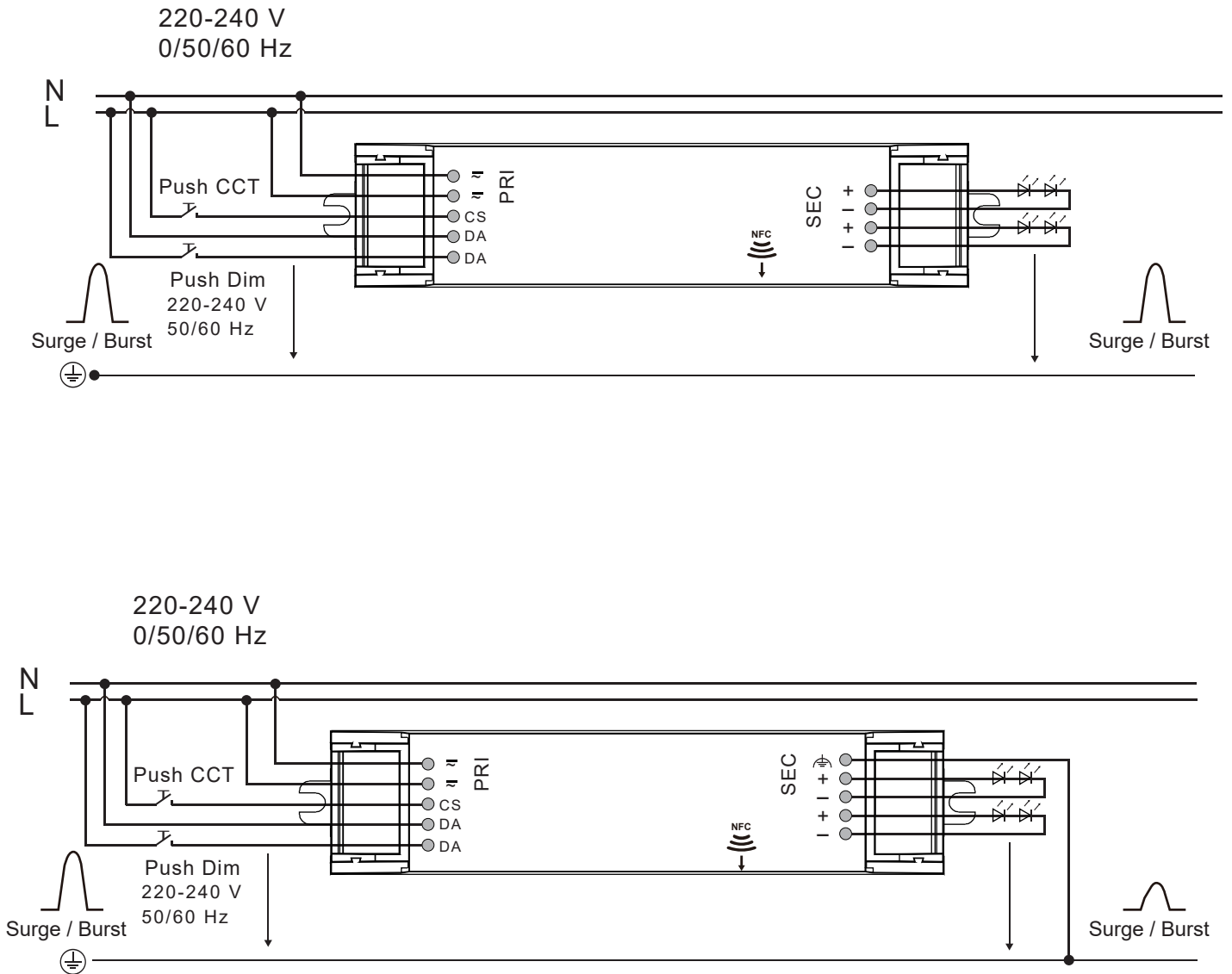

### 5. Electrical values

#### 1. Operating power windows

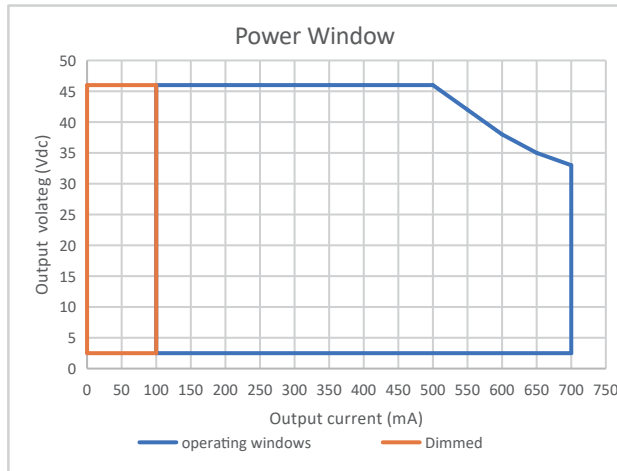

#### 2. Efficiency v.s. Load

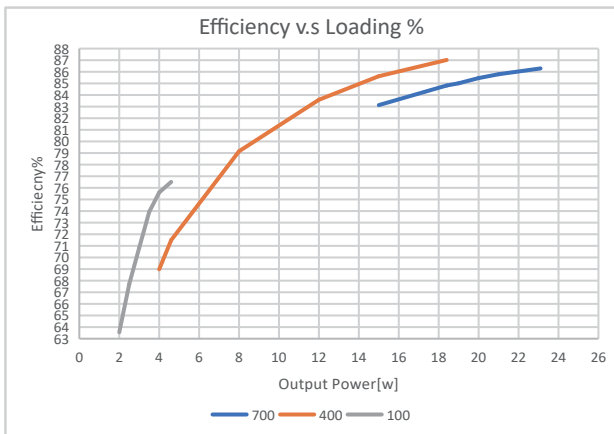

#### 3. PF v.s. Load

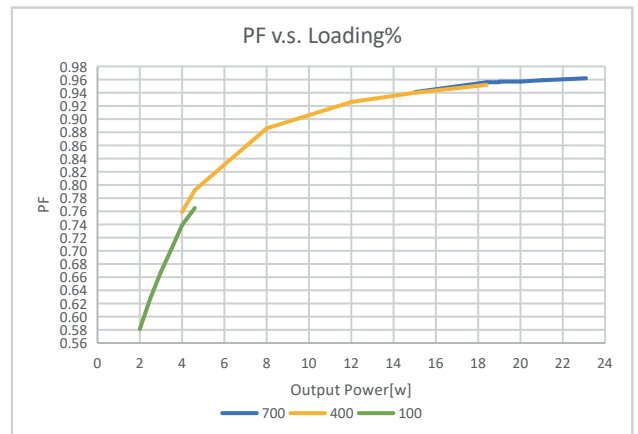

#### 4. THD v.s. Load

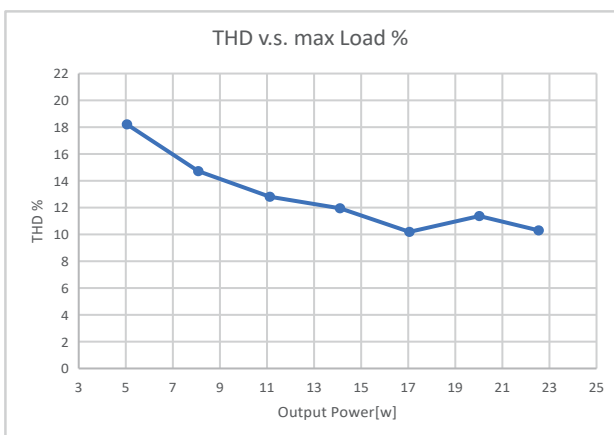

#### 5. Life time

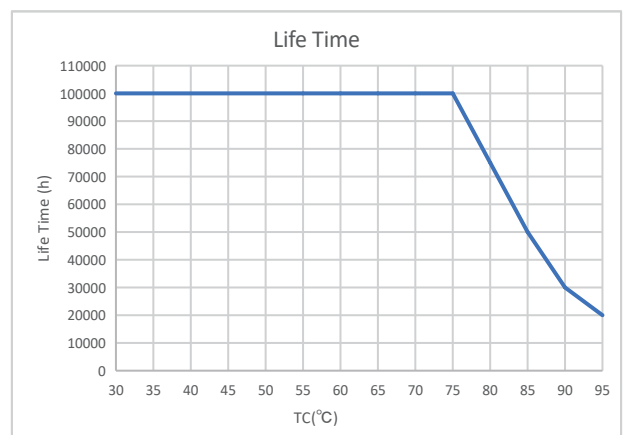

## 6. DALI dimming curve

formula for DALI dimming.

$$X(n) = 10^{\left\{ \left[ \frac{(n-1)}{(253/3)} \right] - 1 \right\}}$$

Here, n means the target dimming stage of the total 254 stages.

X(n) means the percent of the maximum output current

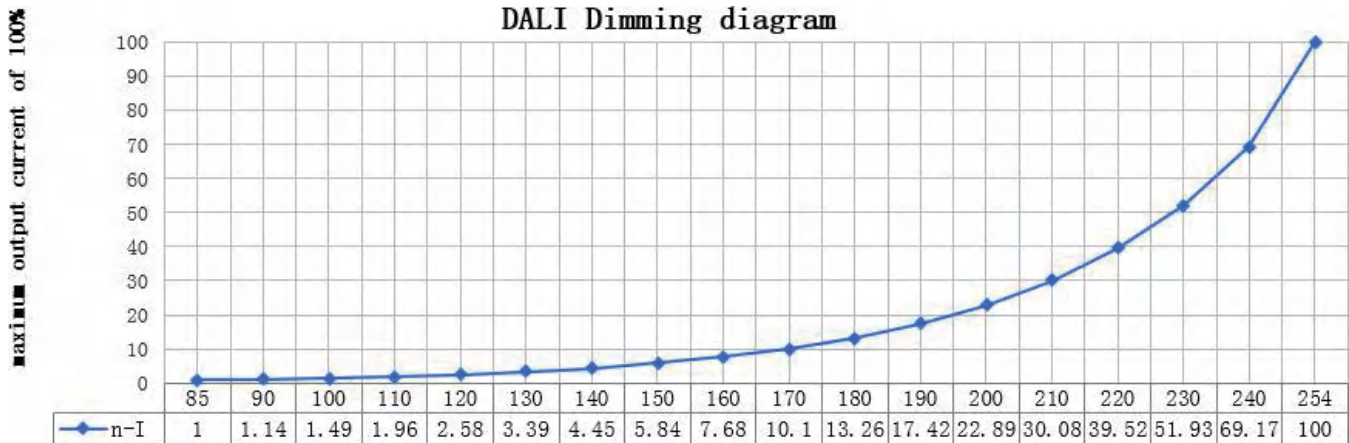

## 7. Colour spectrum at different colour temperatures

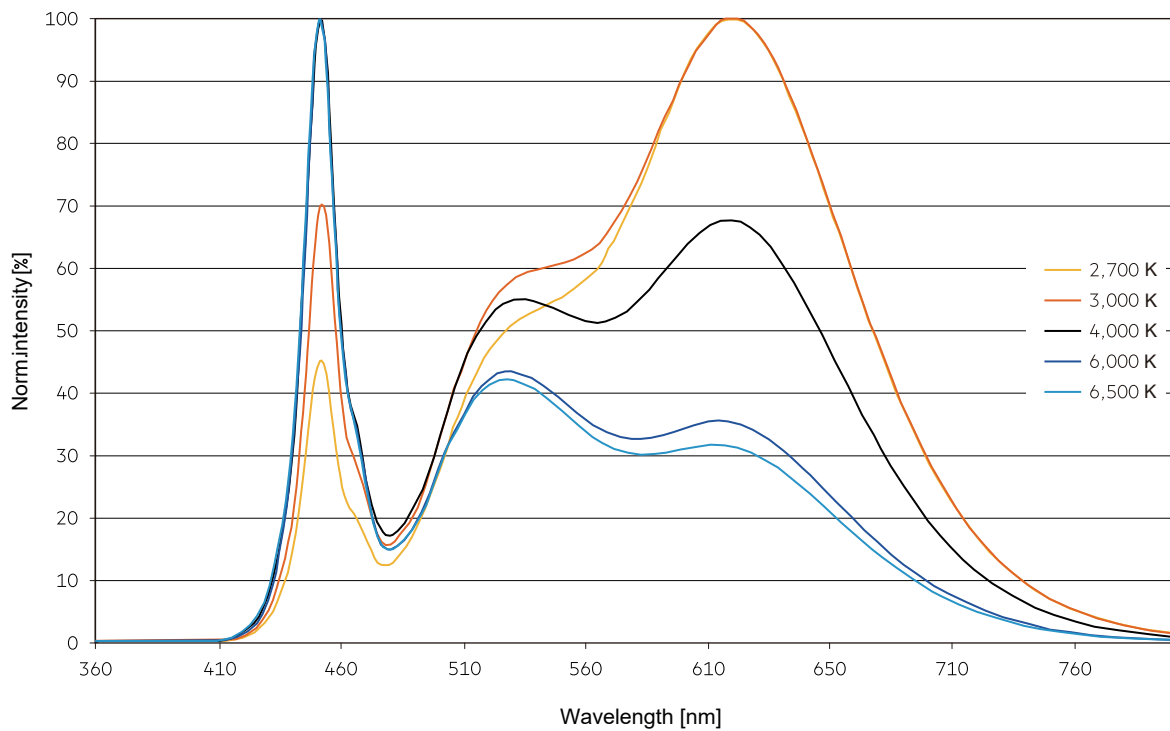

### 8. Function of the earth terminal:



The earth connection is conducted as protection earth (PE). The LED Driver can be earthed via earth terminal or metal housing (if device has metal housing). If the LED Driver will be earthed, protection earth (PE) has to be used. There is no earth connection required for the functionality of the LED Driver. Earth connection is recommended to improve following behaviour.

- Electromagnetic interferences (EMI)
- LED glowing at standby

In general, it is recommended to earth the LED Driver if the LED module is mounted on earthed luminaire parts respectively heat sinks and thereby representing a high capacity against earth.

#### Avoiding residual LED glow on standby

Residual LED glow on standby may occur as a result of capacitive leakage currents from the LED module onto earthed luminaire parts (such as the heat sink). This mainly affects high-efficiency LED systems with large surface areas installed in luminaires with protection class 1.

The topology has been improved so that residual LED glow can be virtually eliminated by earthing the devices.

### 9. Packing information

#### Built in type

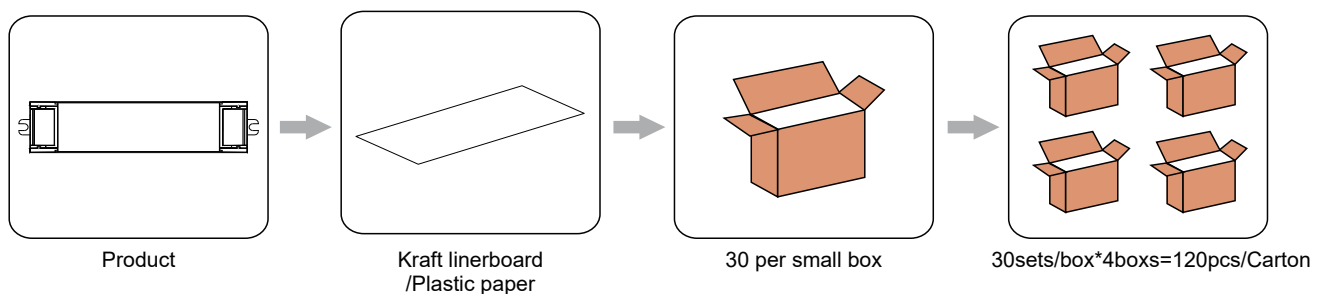

Carton L*W*H(mm)	Pcs/Carton	Net weight/ Pcs(kg)	Net weight/ Carton(kg)	Gross weight / Carton(kg)
310*235*230	120	0.100	12.00	12.56

### Small Strain reliefs

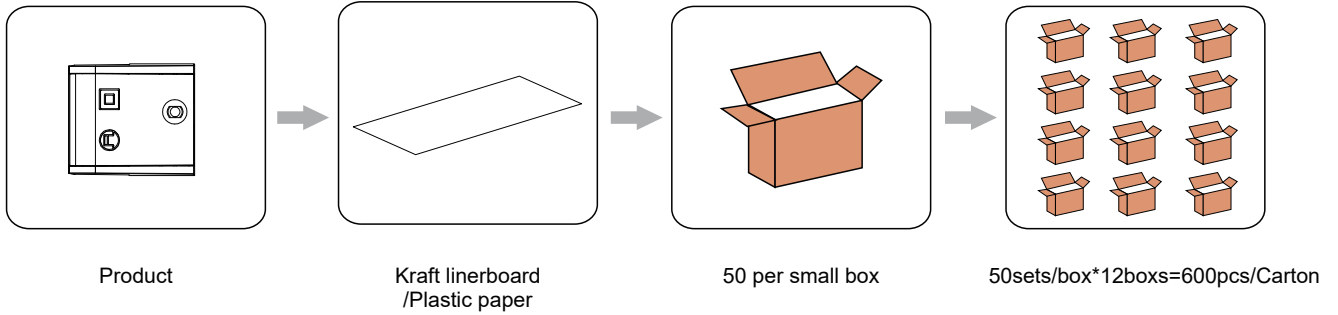

Carton L*W*H(mm)	Pcs/Carton	Net weight/ Pcs(kg)	Net weight/ Carton(kg)	Gross weight / Carton(kg)
500*195*245	600	0.007	4.26	5.56

### Large Strain reliefs

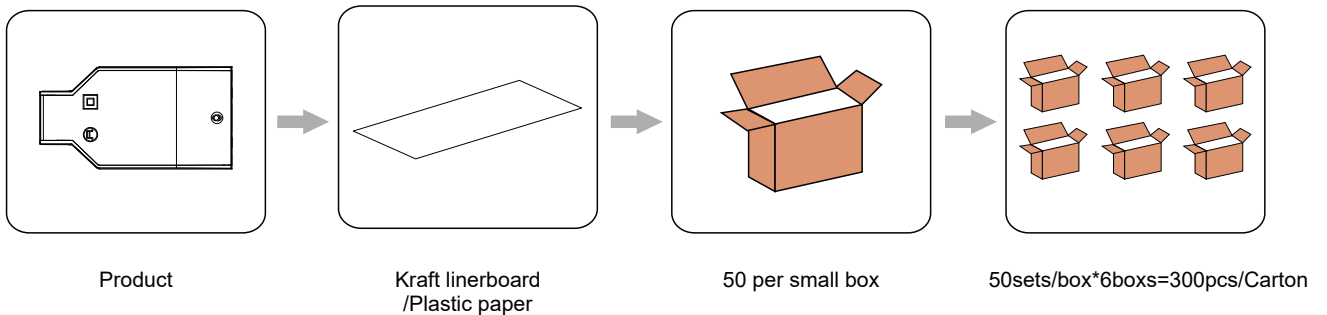

Carton L*W*H(mm)	Pcs/Carton	Net weight/ Pcs(kg)	Net weight/ Carton(kg)	Gross weight / Carton(kg)
375*315*385	300	0.041	12.34	13.9







### 10. NFC current setting:

NFC Reader (optional)

Feature:

Easily on-line read a output current from a driver or write a new current data to a driver throughout KGP NFC reader within few seconds.



Product	Description	Interface	Matching antenna	Zhaga approval	Usage
 ID CPR30+	Desktop programmer	USB	Integrated	Yes	Single Programming on Desktop
 ID ISC.PRH101-USB	Handheld programmer	USB	Integrated	Yes	Single Programming by Handheld
 ID ISC.MR102-USB	Middle range programmer, for connecting external antenna	USB	RF-MANT12786 	Yes	Single Programming on Product line
 ID ISC.LR1002-E	Long range programmer, for connecting external antenna	USB,RS232,TCP/IP	ID ISC.ANT310/310 	Yes	Multi Programming System

### APP NFC

#### Feature:

Quickly check output current of a LED driver simply via iPhone smart phone, as well as, correct or setup a new current data immediately with no extra equipment at any job site.

#### ICON



#### Main



#### Download method

1.Scan the QR code to download



2.On your iPhone, search for KGP NFC in APP Store to download it



iPhone smartphones with NFC can be downloaded and used directly

An iPhone smartphone without NFC requires the following devices to use it

Product	Description	Interface	Matching antenna	Zhaga approval	Usage
 ID ECCO Smart HF-BLE	Handheld wireless programmer	USB,Bluetooth LE V4.2 & V5.0	Integrated	Yes	Handheld programming, installation and maintenance work

## 11. Push Dim :

### 11.1 On / off:

Short push (120ms-600ms) on the switch

Stepless dimming: long push (> 0.6sec) on the switch

### 11.2 Power-on memory function

When the LED driver is powered on, it will restore the memory before the LED driver is powered off. (brightness remembers the brightness after the last dimming is stable, and the brightness during dimming is not memorized)

### 11.3 Light on/off

If the light is on, the light will be off after a short press. If the light is off, the light will be on after a short press. The time range of short press is 120-600mS.

### 11.4 PUSH Dimming

Press and hold the push switch for a long time, the light will enter the dimming state, if the previous time is dimming, it will automatically turn to dimming the next time. After releasing the reset button, the dimming stops and the current illuminance is maintained. The dimming range is 1%-100%. The default is to dim when the power is first long-press. If the brightness of the power-on is the maximum brightness, the first long-press is to dim. (Long press 0.6-3S to start dimming.)

### 11.5 Forced synchronization

Long press for 10 seconds to turn on all the lights and turn on the same brightness (50%), and continue to quickly short press will not change. After a short period of time without short press operation, the module exits the synchronization mode, and the short press restores the switch function.

### 10.6 PUSH Dimming rate

Long press the push switch 10S to switch the dimming rate to 3S, Long press the push switch 20S to switch the dimming rate to 6S, and it can also be changed by MAGIC or production software.

## 12. REVISION HISTORY

Date	Revision	Remark
2024.04.15	V0.01	Label, Packing information, Electrical values, update images