

Constant Current Driver

Model:CC23W100-700CG DALI NFC-1



Model	Output Current	Input Current	Input Power	Output Power Range	PF	Efficiency (*Typical)	Output Voltage	No load Voltage
CC23W100-700CG DALI NFC-1	100mA	0.035A	5.8W	0.90-4.6W	0.74	77%	9-46V	60V
	150mA	0.045A	8.4W	1.35-6.9W	0.83	80%	9-46V	60V
	200mA	0.054A	10.9W	1.80-9.2W	0.89	82%	9-46V	60V
	250mA	0.064A	13.4W	2.25-11.5W	0.92	84%	6-46V	60V
	300mA	0.074A	16.0W	2.70-13.8W	0.94	86%	6-46V	60V
	350mA	0.082A	18.4W	3.15-16.1W	0.96	86%	6-46V	60V
	400mA	0.095A	20.9W	1.00-18.4W	0.97	87%	2.5-46V	60V
	450mA	0.106A	23.5W	1.12-20.7W	0.97	87%	2.5-46V	60V
	500mA	0.116A	26W	1.25-23.0W	0.98	88%	2.5-46V	60V
	550mA	0.093A	20.5W	1.37-22.5W	0.97	86%	2.5-41V	60V
	600mA	0.10A	22.2W	1.50-22.8W	0.97	86%	2.5-38V	60V
	650mA	0.108A	24.1W	1.62-22.7W	0.98	86%	2.5-35V	60V
	700mA	0.114A	25.7W	1.75-22.4W	0.98	86%	2.5-32V	60V

* Test result @230V, 50Hz, Full Load.Current setting @ 1mA-steps (NFC)

1. Parameters

Category	Item	Technical Norm
Features	Output Type	Constant Current
	Dimming Type	DALI-2 / Push DIM
	Output current setting	Near field communication (NFC)
	Output Features	Isolation
	IP Grade	IP20
	Insulation Class	Class II
Input	Rated Input Voltage	220-240VAC
	Range of Input Voltage	198-264VAC
	Range of DC Input Voltage	180-280VDC
	Frequency	0/50/60Hz
	Input Current	≤0.16A max
	Input Power	≤28W max
	Power Factor	≥0.95 (230VAC , full load)

	THD	≤15% (230VAC , full load)
	Standby Power Consumption	≤0.5W (230VAC , DIM to off)
	Inrush Current	≤40A/15us (230VAC , full load)
Output	Output Voltage	9-46VDC@100-200mA ; 6-46VDC@201-400mA ; 2.5-46VDC@401-500mA ; 2.5-41VDC@501-550mA ; 2.5-38VDC@551-600mA ; 2.5-35VDC@601-650mA ; 2.5-32VDC@651-700mA .
	No Load Voltage (Uout)	60VDC Max.
	Output Current	100-700mA (by NFC setting)
	Max. Output Power	23W
	Efficiency	≥88% (230VAC , 46Vdc@500mA)
	Output LF current ripple (< 120 Hz)	±5% (Imax-Imin) / (Imax+Imin)
	Current Accuracy	±5%@ 301-700mA, ±10%@ 100-300mA
	Output PstLM (at full load)	≤ 1
	Output SVM (at full load)	≤0.4
	Starting Time	≤0.7S (230VAC , full load, by DALI system)
	Control Method	PUSH dimming
DALI function		DALI dimming (Max. lead wire length: 300m) logarithm or linear dimming curve selectable 251,252,253,CLO
Dimming range		DALI dimming: 1%-100% ,Dim to off .
Current Interface		Near field communication (NFC)
NFC current setting		1mA-steps (NFC)
Protection	Short Circuit Protection	Auto Recovery
	Overload Protection	Auto Recovery (not be hot swap)
	No-load Protection	Auto Recovery
	Insulation voltage	3000V 5mA 60S between P-S
	Insulation resistance	>100M ohm @ 500VDC
	Leakage current	I/P to O/P <0.7mA
Environment	Ta/Operation Temperature	-25+50°C
	Ts/Storage Temperature	-25+85°C
	Tc/Enclosure Temperature	85°C
	Humidity	10%.... 90%RH
	Atmosphere	86- 108KPa
Construction	Connection Method	Push-in Terminal
	Installation	Built-in & Independent
	PRI Wire preparation	0.75- 1.5 [□] / 8mm
	SEC Wire preparation	0.5- 1.5 [□] / 8mm
	DALI Wire preparation	0.5- 1.5 [□] / 8mm
	Dimension	Independent: 138.7*31*21.5mm (L*W*H) Built-in: 118.3*31*21.5mm (L*W*H)
Standards	Certification	ENEC CE SAA EAC EL
	Safety Standards	EN 61347-1:2015/A1:2021 EN 61347-2-13:2014/A1:2017

		EN IEC 62384:2020 EN 62493:2015/A1:2022 AS61347.2.13:2018 AS/NZS61347.1:2016 Inc A1
	EMC Standards	EN IEC 55015:2019 EN IEC 55015:2019/A11:2020 EN IEC 61000-3-2:2019/A1:2021 EN 61000-3-3:2013/A2:2021 EN IEC 61547:2023
	RED	EN 300 330 V2.1.1:2017 EN 301 489-1 V2.2.3:2019 EN 301 489-3 V2.3.2:2023 EN 62479:2010 EN 50663:2017
	Performance	EN 62384
	DALI performance	IEC 62386- 101 (ed2.0) IEC 62386- 102 (ed2.0) IEC 62386- 207 (ed1.0) IEC 62386- 251 (ed2.0) IEC 62386- 252 (ed2.0) IEC 62386- 253 (ed2.0)
	Surge	L-N:2kV
Others	RoHS	complied to 2011/65/EU
	Life Time	50000h @Ta=50°C
	Warranty	5years , F.R. < 10000ppm
	Audible Noise	<20dB @ 30cm distance, 16dB background

Remark:

- 1.All Parameters, if not specified, are measured at 230VAC/50Hz and 25°C ambient temperature.
- 2.LED Driver is a component of the luminaires, Luminaires and wire layout will affect the EMC, please check the EMC with end products again.
- 3.Do not install upside down.

2. Connected quantities of different current Breaker

TYPE	Connected quantities of different current Breaker						Input Voltage (V)	Inrush Current(A)	Time (µs)
	current (A)	10	13	16	20	25			
	Installation wire diameter	1.5mm ²	2.5mm ²	2.5mm ²	4mm ²	4mm ²			
TYPE B		15	20	24	30	38	@230VAC	40	15
TYPE C		24	31	38	48	60			
TYPE D		38	50	61	77	96			

3. Label

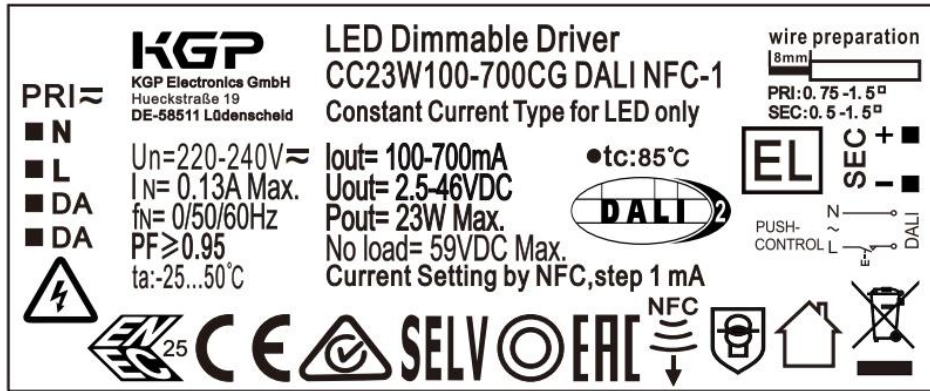

4. Electrical values

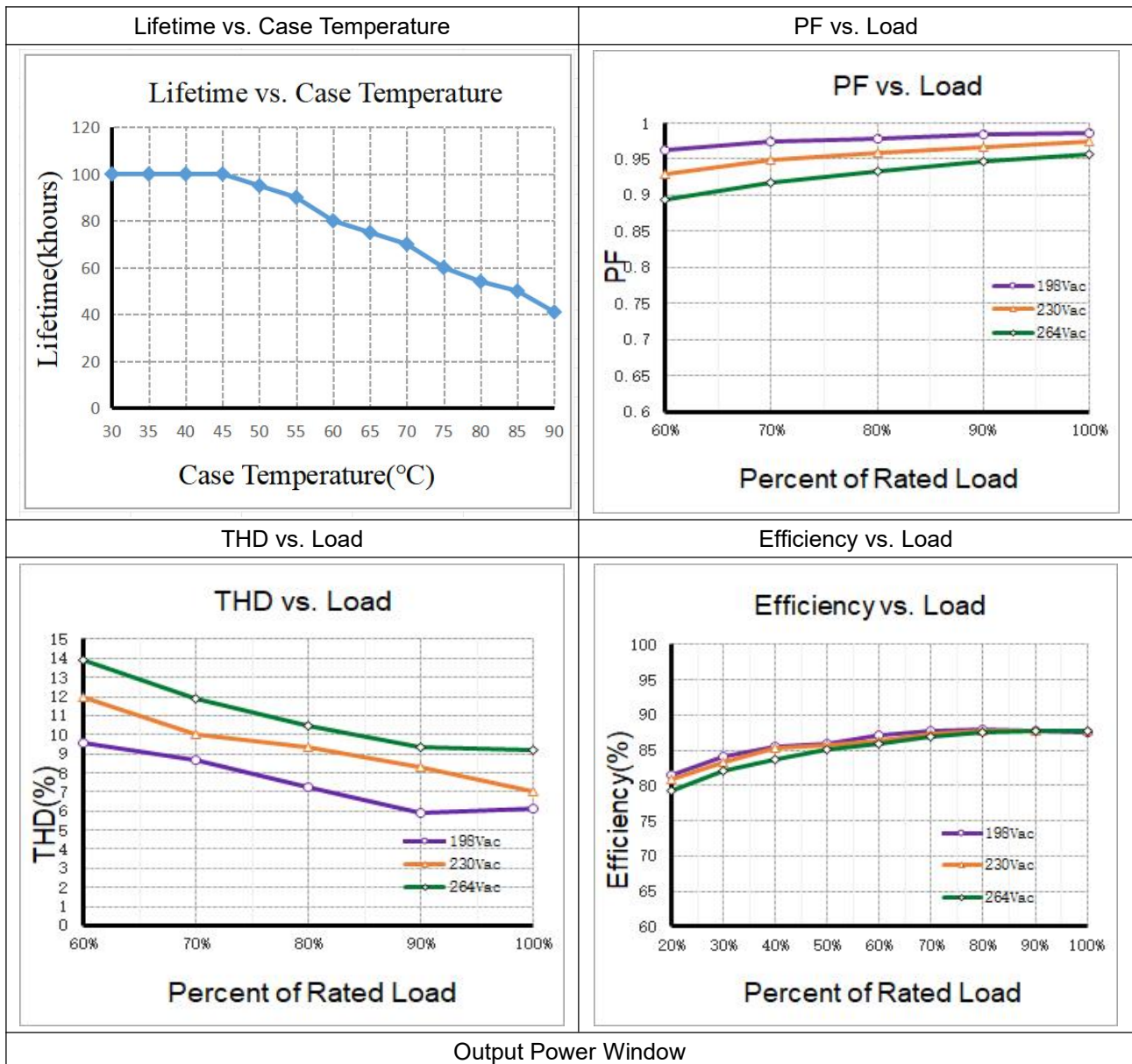

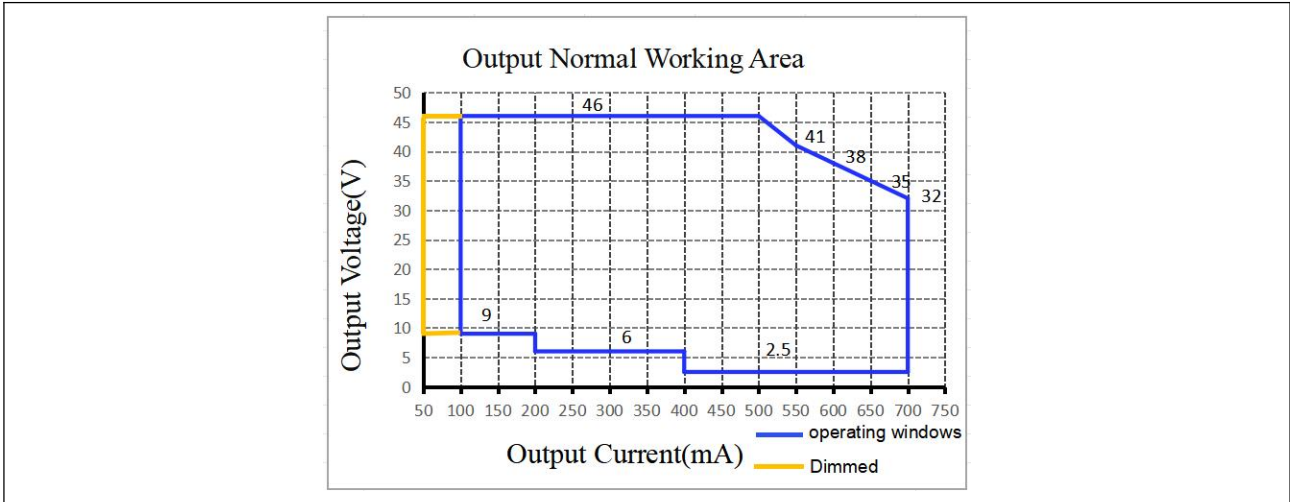

5. DALI dimming curve

formula for DALI dimming.

$$X(n) = 10^{\left\{ \left[\frac{(n-1)}{253/3} \right] - 1 \right\}}$$

Here, n means the target dimming stage of the total 254 stages.

X(n) means the percent of the maximum output current

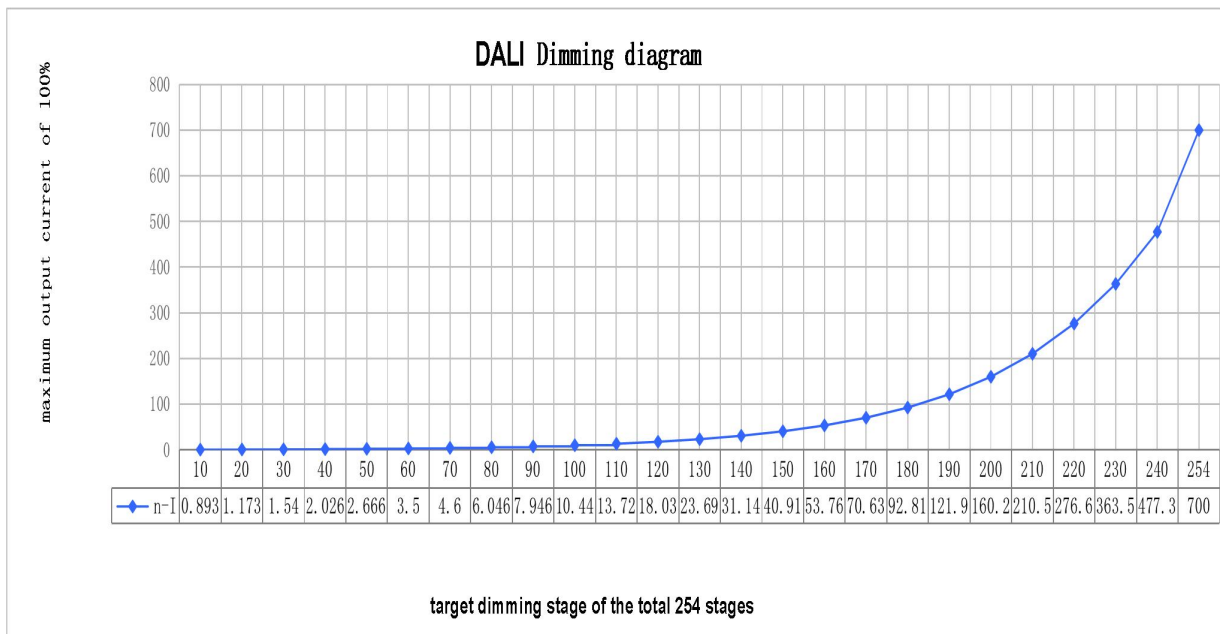

6. Dimension (Unit: mm)

Independent type :

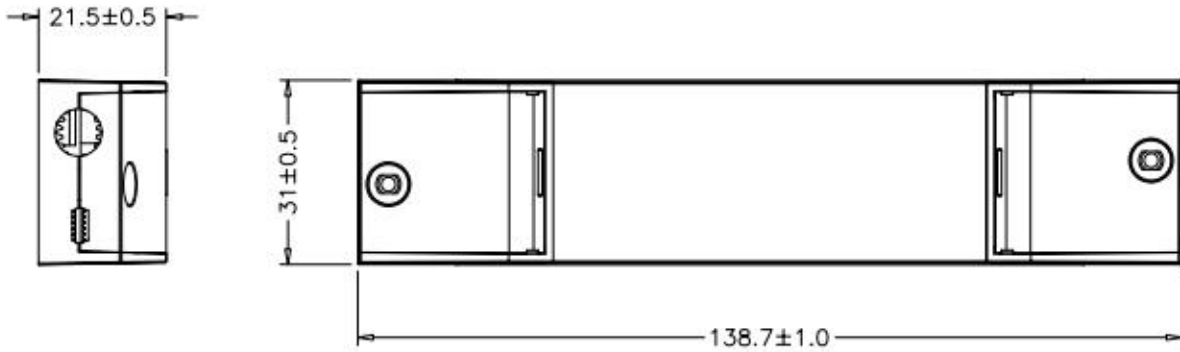

Built in type:

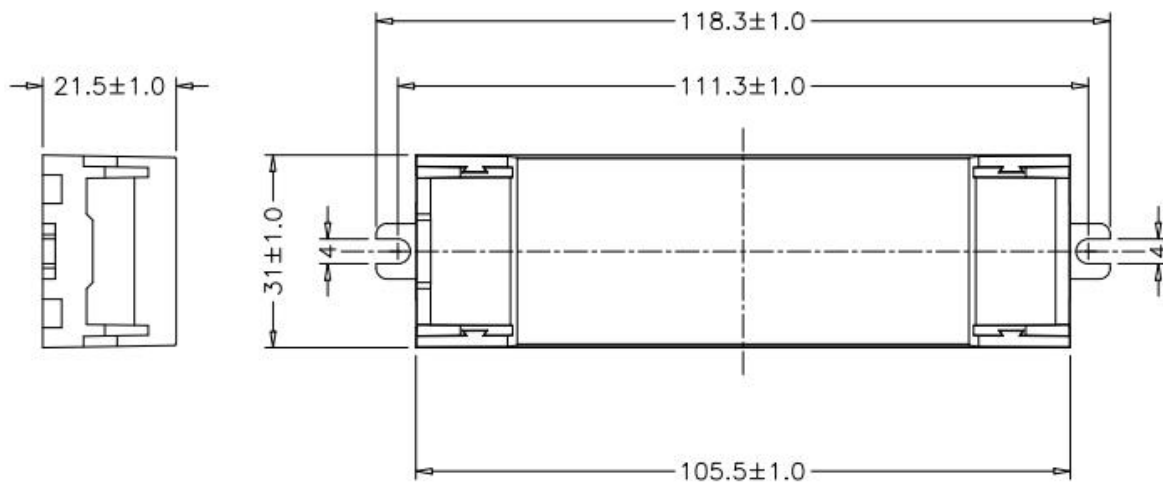

7. Wiring Diagram

Fig. A: Push Dimming



Fig. B: DALI Dimming



8. Packing information

Packing way	Model	Carton L*W*H(mm)	Pcs/ Carton	Net weight/ Pcs(kg)	Net weight/ Carton(kg)	Gross weight/ Carton(kg)
Built in (without white box and manual)	CC23W100-700 DALI NFC-1	275*170*235	80	0.077	6.16	6.96
Independent (without white box and manual)	CC23W100-700CG DALI NFC-1	370*185*245	100	0.089	8.9	9.46

9. Wiring instructions

- All connections must be kept as short as possible to ensure good EMI behaviour
- Mains leads should be kept apart from LED Driver and other leads (ideally 5 - 10 cm distance)
- Advice the maximum length of output wires is 3 m
- Secondary switching is not permitted (Except for constant voltage)
- Incorrect wiring can damage LED modules
- The wiring must be protected against short circuits to earth (sharp edged metals parts, metal cable clips, louver, etc.)
- Hot plug-in is not supported due to residual output voltage of > 0 V up to mains voltage. Danger to life.
- When connecting an LED load, restart the device to activate the LED output.
- This can be done via mains reset or via interface (DALI, DSI, switch DIM).

10. Replace LED module

- Mains off
- Remove LED module
- Wait for 30 seconds
- Connect LED module again

Hot plug-in or secondary switching of LEDs is not permitted and may cause a very high current to the LEDs

11. Functions

11.1 OEM Identification

The OEM (Original Equipment Manufacturer) can set his own identification number.

DALI Part 251: Memory bank 1 extension.

11.2 OEM GTIN

The Original Equipment Manufacturer (OEM) can set his own Global Trade Item Number (GTIN).

DALI Part 251: Memory bank 1 extension.

11.3 Luminaire data

This function provides the asset management with accurate data about the luminaire.

DALI Part 251: Memory bank 1 extension.

DALI Part 253: Luminaire maintenance data.

11.4 LED current

The LED output current must be adapted to the connected LED module.

The value is limited by the current range of the respective device.

The output current of the LED driver can be adjusted in a certain range.

Adjustment is done by KGP Configurator via NFC.

More functions:

Action	Action duration	Function
Short push	<0.6s	Turn on/off
Short push five Times	<3s	Quit Corridor mode
Long push	0.6-3s	Dimming up or down
Long push	10s	Sync all LEDs to be 50% brightness, and the dimming rate is changed to 3S
Long push	20s	Dimming rate is changed to 6S
Long push	>2mins	Enter Corridor mode - LED keep 100% brightness for 2mins.

11.5 Switch DIM

Integrated Switch DIM function allows a direct connection of a push button for dimming and switching.

Brief push (< 0.6 s) switches LED driver ON and OFF. The dim level is saved at power-down and restored at power-up.

When the push button is held, LED modules are dimmed. After repush the LED modules are dimmed in the opposite direction.

In installations with LED drivers with different dimming levels or opposite dimming directions (e.g. after a system extension), all LED drivers can be synchronized to 50 % dimming level by a 10 s push.

Use of push button with indicator lamp is not permitted.

11.6 Corridor FUNCTION

With the Corridor FUNCTION and a commercially available motion detector, it is easy to adapt the lighting in one area to its use.

That is, when the area is entered by a person, the lighting dims instantly to the desired brightness and is available in full strength.

After the area is left by the person, the brightness dims slowly to a smaller value or switches off completely.

The individual parameters of the desired profile, such as brightness values or delay times, can be adjusted flexibly and individually.

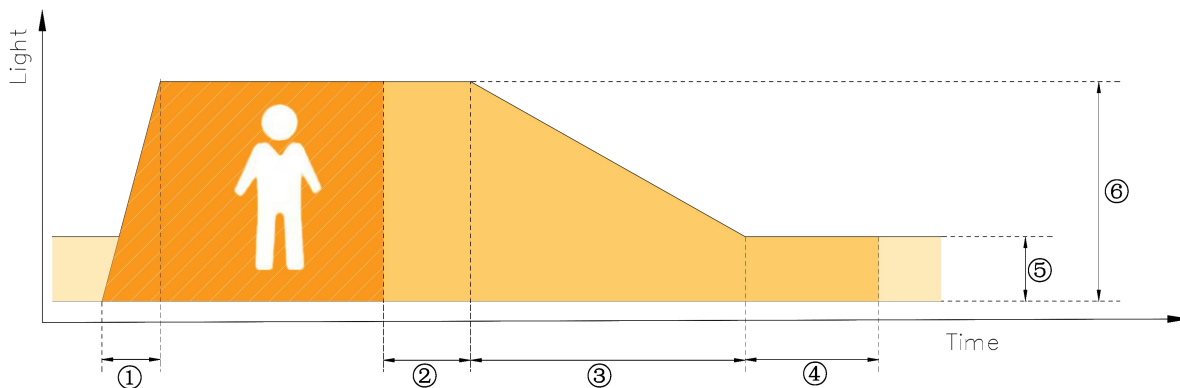

- ① Fade-in time(1s): the time that starts as soon as the presence of a person is detected. During the fade-in time the luminous intensity is faded up to the presence value.
- ② Run-on time(120s): the time that starts as soon as the presence of a person is no longer detected. If the presence of a person is detected again during the run-on time the run-on time is restarted from zero. If no presence is detected during the run-on time the fade time is started as soon as the run-on time expires.
- ③ Fade time(32s): the time during which the luminous intensity is faded from the presence value to the absence value.
- ④ Switch-off delay (Never Off): the time during which the absence value is held before the lighting is switched off. Depending on the profile selected the switch-off delay may have different values or may not be defined.
- ⑤ Absence value(default: 10 %): the luminous intensity when there is no person present.
- ⑥ Presence value (default: 100 %): the luminous intensity when persons are present.

11.7 Constant Light Output (CLO)

With this function the light output of the LED module can be kept equal over the lifetime.

The light output of an LED module reduces over the course of its lifetime.

The Constant Light Output (CLO) function compensates for this natural decline by constantly increasing the output current of the LED driver throughout its lifetime.

CLO shall be achieved by limitation of the LED current at the commissioning of the LED driver and providing a linear interpolation of the current over the time, depending on the data points given by the user.

The user has to insert up to eight pairs of data (time, level).

The output curve is the result of connecting the user data points linear.

Detailed description for CLO see product manual.

The minimal CLO starting point is limited by the smallest output current of the LED driver.

11.8 Dimming curve

DALI: The desired dimming behaviour is selected via two different dimming curves (logarithmic or linear).

The default setting of the dimming behaviour is logarithmic.

12. REVISION HISTORY

DATE	VER	REMARK
2024-05-29	V1.0	Initial release
2025-11-06	V1.1	Update product labels