

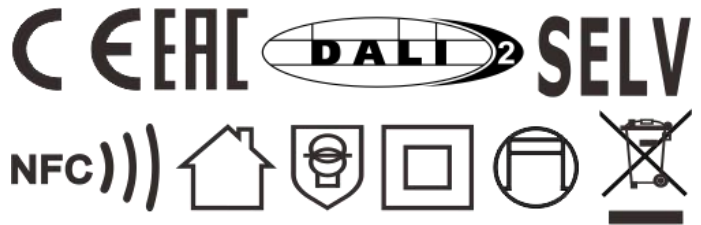

Constant Current Dimmable Driver

Model:CC15W100-700 DALI NFC-1



Model	Output Current (*Typical)	Input Current	Input Power	Output Power Range	PF	Efficiency	Output Voltage	No load Voltage
CC15W100-700 DALI NFC-1	100mA	0.04A	6.5W	0.25-4.50W	0.6	83%	2.5-45V	59V
	200mA	0.07A	11.5W	0.50-9.00W	0.8	85%	2.5-45V	59V
	300mA	0.10A	16.8W	0.75-13.50W	0.85	85%	2.5-45V	59V
	400mA	0.11A	18.8W	1.00-15.20W	0.9	84%	2.5-38V	59V
	500mA	0.11A	18.6W	1.25-15.00W	0.9	84%	2.5-30V	59V
	600mA	0.11A	18.5W	1.50-15.00W	0.9	84%	2.5-25V	59V
	700mA	0.11A	19.0W	1.75-15.4W	0.9	84%	2.5-22V	59V

* Test result @230V, 50Hz, Full Load. Current setting @ 1mA-steps (NFC)

1. Parameters

Category	Item	Technical Norm
Features	Output Type	Constant Current
	Dimming Type	DALI-2
	Output Features	Isolation
	IP Grade	IP20
	Insulation Class	Class II
Input	Rated Input Voltage	220-240VAC
	Range of Input Voltage	198-264VAC or 198-280VDC
	Frequency	50/60Hz
	Input Current	≤0.11A (230VAC, full load)
	Input Power	≤19.0W (230VAC, full load)
	Power Factor	≥0.9 (230VAC, full load)
	THD	≤20% (230VAC, full load)
	Standby power(dim to off)	≤0.5W @230VAC
Output	Output Voltage Range	2.5-45VDC@100-300mA
		2.5-38VDC@400mA
		2.5-30VDC@500mA
		2.5-25VDC@600mA

		2.5-22VDC@700mA
	No Load Voltage	59VDC Max.
	Output Current	100mA -700mA (Max. output)
	Max. Output Power	15W
	Efficiency	≥84% (230VAC, full load)
	Current Ripple(< 120 Hz)	±5% (Imax-Imin)/(Imax+Imin)
	PstLM	≤1
	SVM	≤0.4
	Current Accuracy	±5% (@300-700mA) ±8% (@100-200mA)
	Started Delay Time	≤1S(230VAC, full load)
Control Method	Secondary PUSH dimming	Secondary PUSH dimming (Max. lead wire length : 20m,same port of DALI)
	PUSH-button	Max parallel connections qty for Push-dim 15 PCS
	DALI function DALI	DALI dimming (Max. lead wire length: 300m)logarithm or linear dimming curve selectable 251,252,253,CLO
	Dimming range	DALI dimming: 1%-100% ,Dim to off .
	Suitable for emergency escape lighting systems acc	The emergency function of this product is turned off
	Current Interface	Near field communication (NFC)
	Adjustable output current	1mA-steps (NFC)
Protection	Short Circuit Protection	Auto Recovery
	Overload Protection	Auto Recovery
	No-load Protection	Auto Recovery
	Insulation voltage	3000V 5mA 60S between P-S
	Insulation resistance	>100M ohm @ 500VDC
	Leakage current	< 250µA, I/P to O/P or I/P to PE @230V input
Environment	Ta/Operation Temperature	-25....+50°C
	Ts/Storage Temperature	-35....+85°C
	Tc/Enclosure Temperature	80°C
	Humidity	10%....90%RH
	Atmosphere	86-108KPa
Construction	Connection Method	Direct Lead
	Installation	Built-in
	SEC Wire preparation	0.5-1.5 ^φ
	Dimension	64.5*40*23mm (L*W*H)
Standards	Certification	CE
	Safety Standards	EN 61347-1:2015/A1:2021 EN 61347-2-13:2014/A1:2017 EN IEC 62384:2020 EN 62493:2015 AS61347.2.13:2018 AS/NZS61347.1:2016 Inc A1 BS EN 61347-1:2015/A1:2021 BS EN 61347-2-13:2014/A1:2017 BS EN 62493:2015

		BS EN IEC 62384:2020
	EMC Standards EMC	EN IEC 55015:2019 EN IEC 55015:2019/A11:2020 EN IEC 61000-3-2:2019/A1:2021 EN 61000-3-3:2013/A2:2021 EN 61547:2009
	Performance	EN62384:2020
	Surge	L-N/1KV
Others	RoHS	complied to 2011/65/EU
	Life Time	50000h @Ta/ Tc
	Warranty	5years ,F.R. < 10000ppm
	Noise	≤ 24dB @Background noise ≤18dB , Interval≥15cm

Remark:

- All Parameters, if not specified, are measured at 230VAC/50Hz and 25°C ambient temperature.
- LED Driver is a component of the luminaires, Luminaires and wire layout will affect the EMC, please check the EMC with end products again.
- During the PUSH DIM test, the number of parallel connections must be less than 15PCS

2. Connected quantities of different current Breaker

TYPE	Connected quantities of different current Breaker						Input Voltage	Inrush Current (A)	Time
	current (A)	10	13	16	20	25			
	Installation wire diameter	1.5mm ²	2.5mm ²	2.5mm ²	4mm ²	4mm ²			
TYPE B		9	12	15	18	23	@230VAC	65	200US
TYPE C		15	19	24	30	37			
TYPE D		24	31	38	47	59			

3. Label



4. DALI dimming curve

formula for DALI dimming.

$$X(n) = 10^{\left\{ \frac{(n-1)}{253/3} \right\} - 1}$$

Here, n means the target dimming stage of the total 254 stages.

X(n) means the percent of the maximum output current

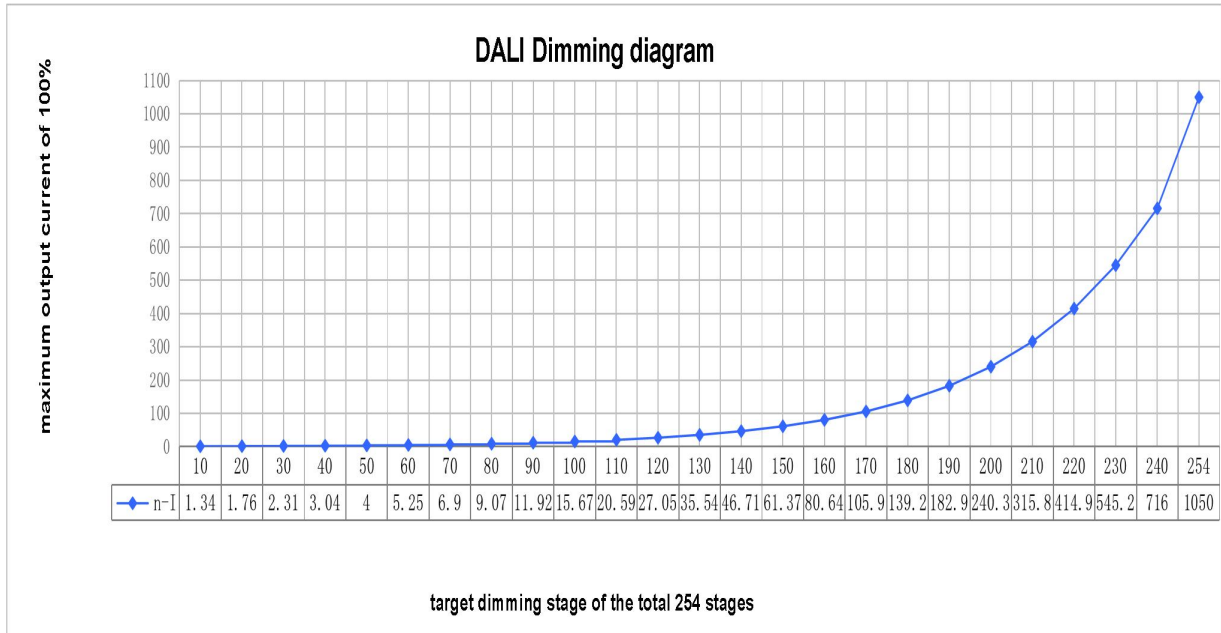

5. Electrical values

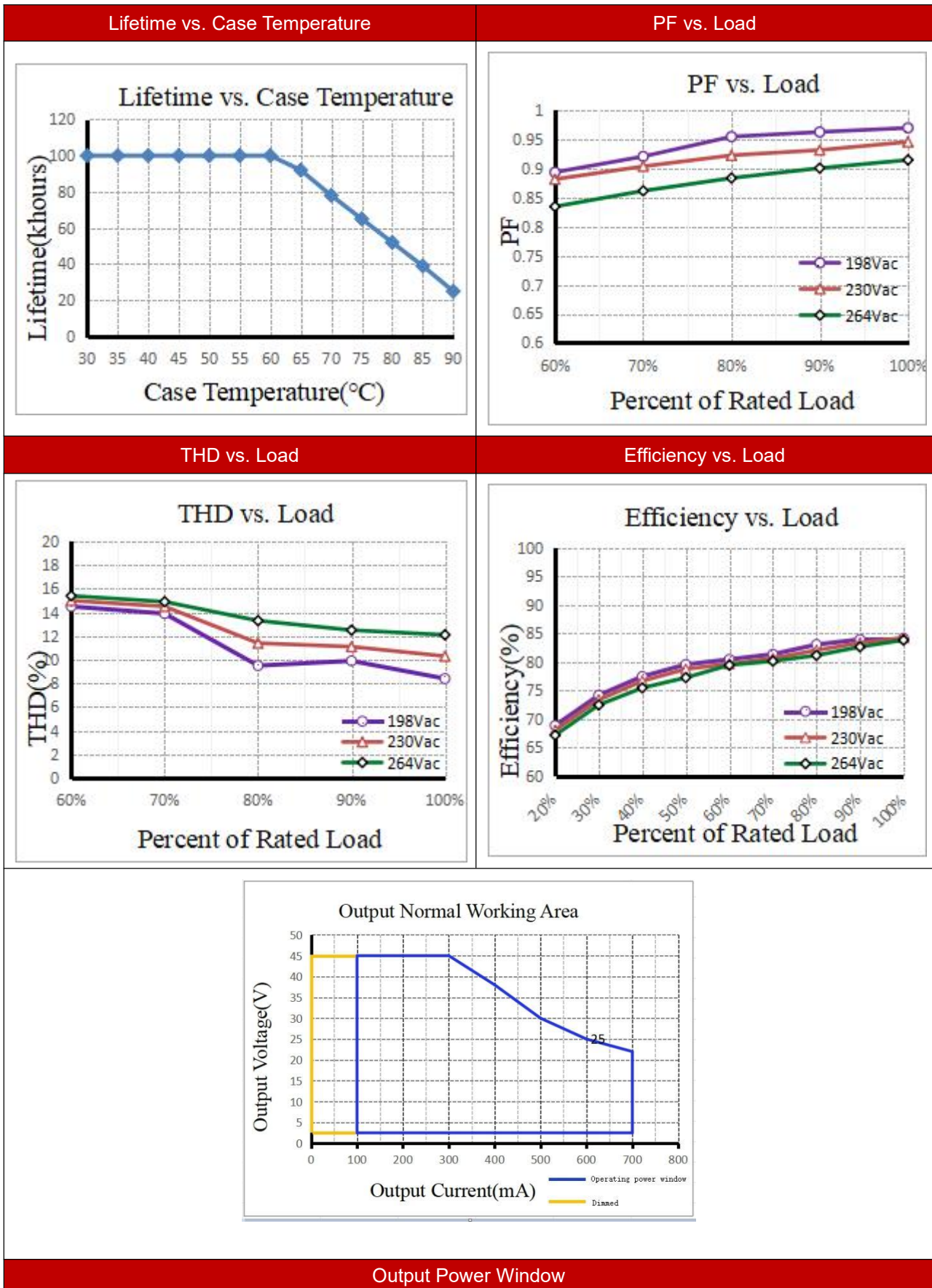

6. Dimension

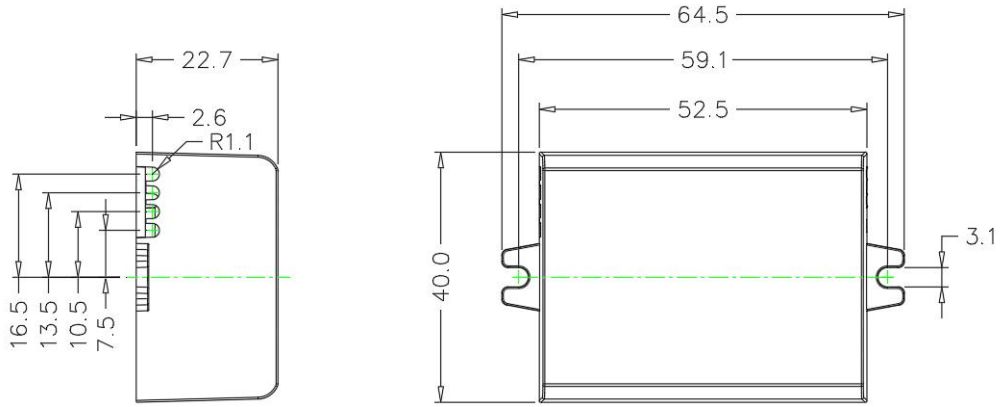

7. Packing information

Packing way	Model	Colour	Carton L*W*H(mm)	Pcs/ Carton	Net weight/ Pcs(kg)	Net weight/ Carton(kg)	Gross weight/ Carton(kg)
industrial	C10C150-500N-C	White	L320*W310*H105	160	0.068	10.88	12.38

8. Wiring Diagram

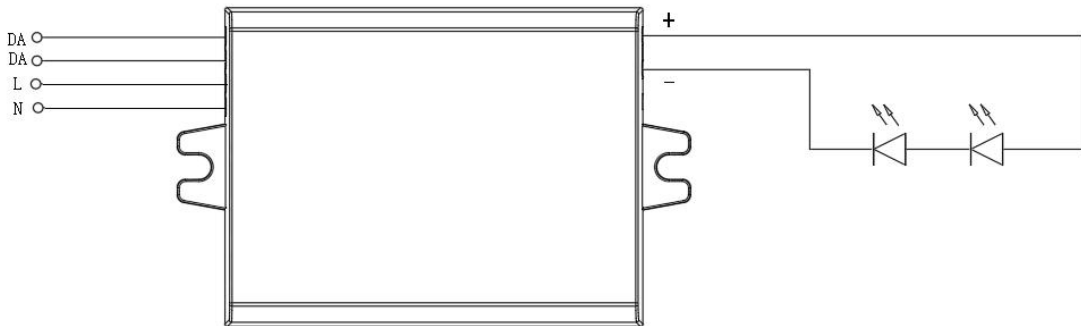

9. Wiring instructions

- All connections must be kept as short as possible to ensure good EMI behaviour
- Mains leads should be kept apart from LED Driver and other leads (ideally 5 – 10 cm distance)
- Advice the maximum length of output wires is 3 m
- Secondary switching is not permitted (Except for constant voltage)
- Incorrect wiring can damage LED modules.
- The wiring must be protected against short circuits to earth (sharp edged metals parts, metal cable clips, louver, etc.)
- Hot plug-in is not supported due to residual output voltage of > 0 V up to mains voltage. Danger to life.
- When connecting an LED load, restart the device to activate the LED output.
- This can be done via mains reset or via interface (DALI, DSI, switch DIM).

10. Replace LED module

- Mains off
- Remove LED module
- Wait for 30 seconds
- Connect LED module again

Hot plug-in or secondary switching of LEDs is not permitted and may cause a very high current to the LEDs

11. NFC instructions

REMARK:

You are advised to set DALI parameters when the power supply is not enabled





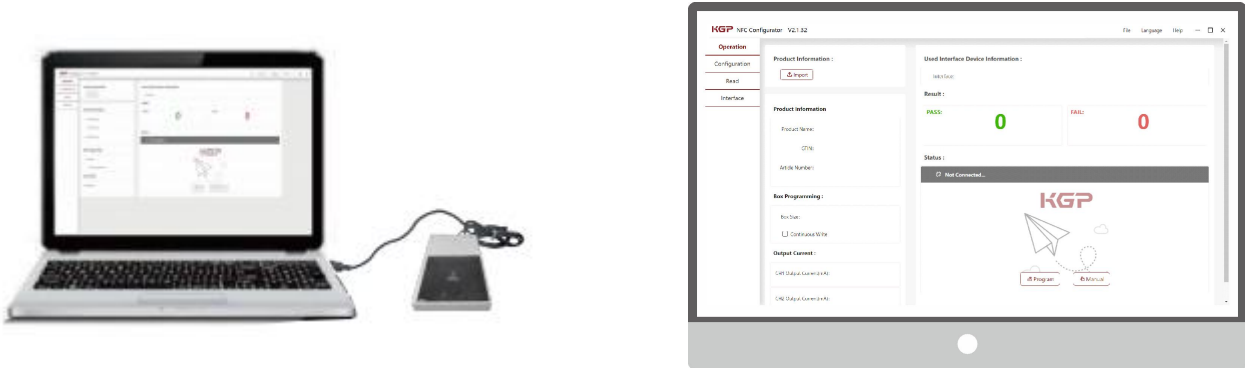

Make sure your phone has NFC capability and has it activated.

NFC Reader (optional)

Feature:

Easily on-line read a output current from a driver or write a new current data to a driver throughout KGP NFC reader within few seconds.



Product	Description	Interface	Matching antenna	Zhaga approval	Usage
 ID CPR30+	Desktop programmer	USB	Integrated	Yes	Single Programming on Desktop
 ID ISC.PRH101-USB	Handheld programmer	USB	Integrated	Yes	Single Programming by Handheld
 ID ISC.MR102-USB	Middle range programmer , for connecting external antenna	USB	RF-MANT12786 	Yes	Single Programming on Product line
 ID ISC.LR1002-E	Long range programmer , for connecting external antenna	USB,RS232,TCP/IP	ID ISC.ANT310/310 	Yes	Multi Programming System

Step 1: Connect FEIG reader

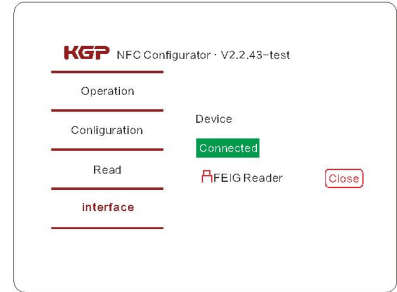
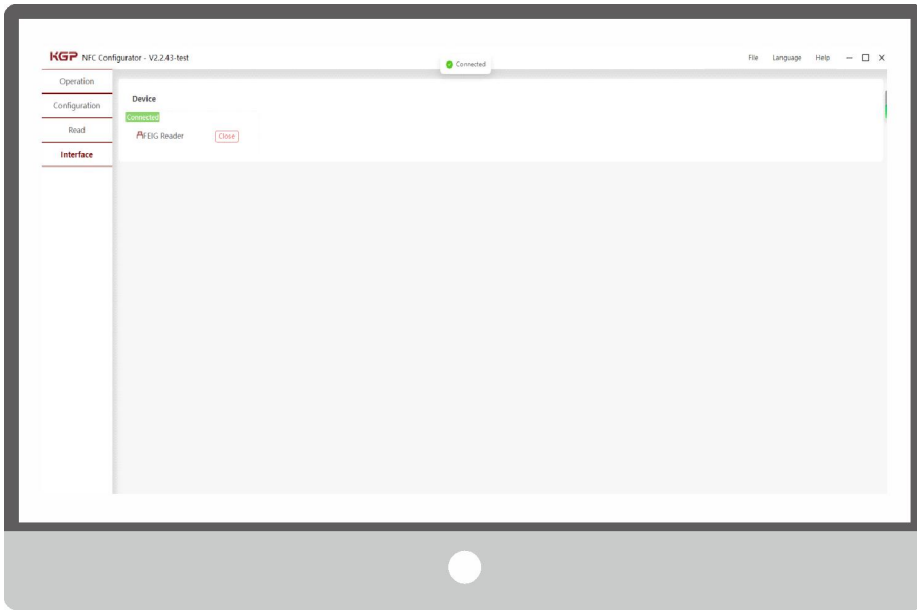

Step 2: Read product information

Click "Read" button to read

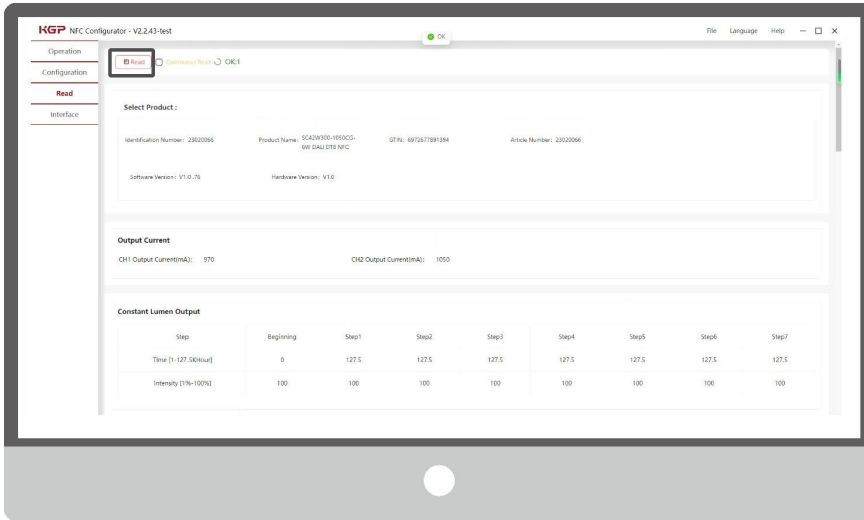

Step 3: Few parameter interface, you can choose the setting based on your requirements.

Select product name

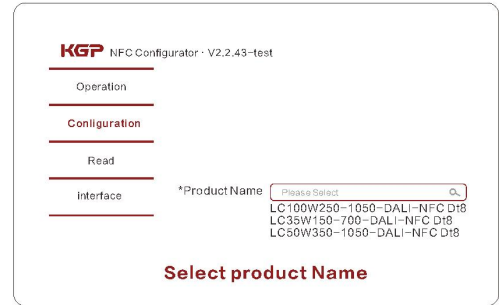
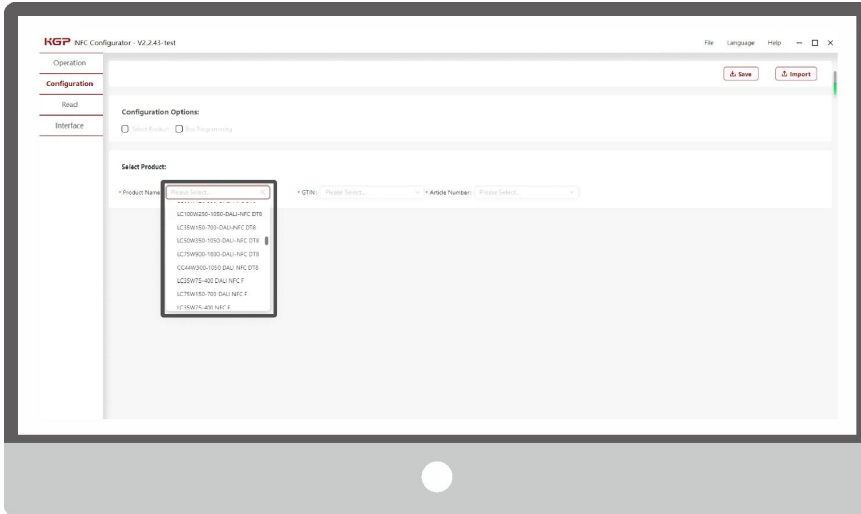

Output current setting:

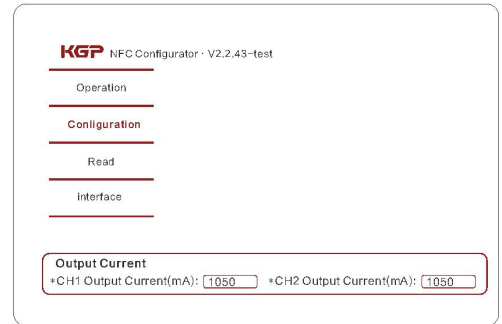
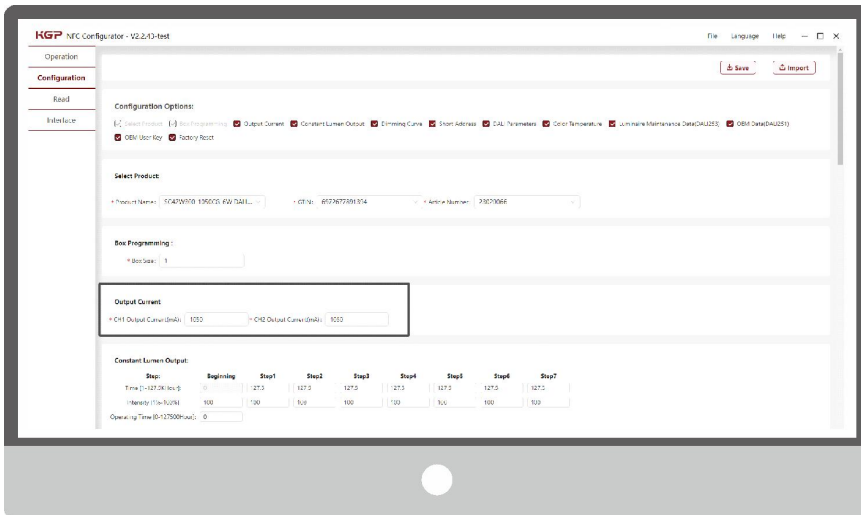

Enter CLO setting:

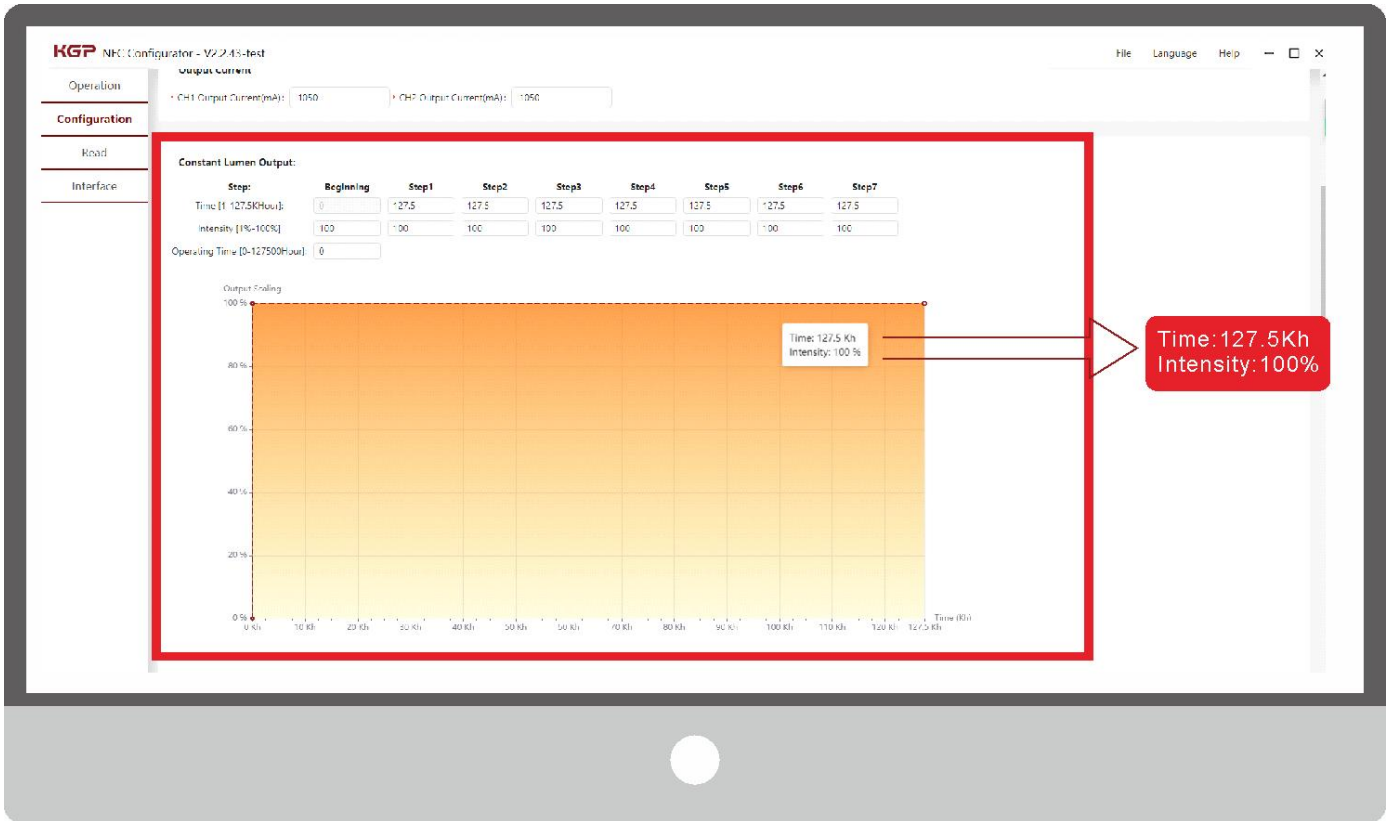

Dimming curve setting:

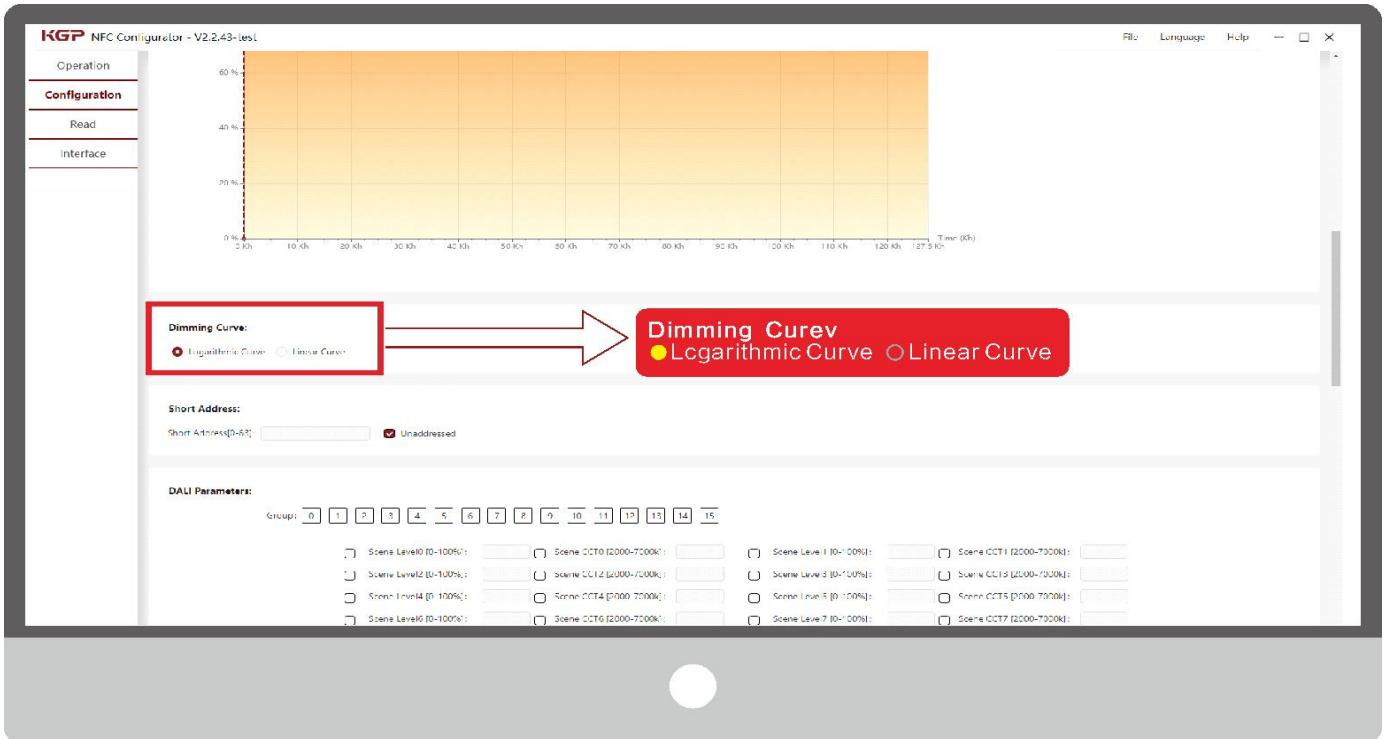

Assign Short Address :

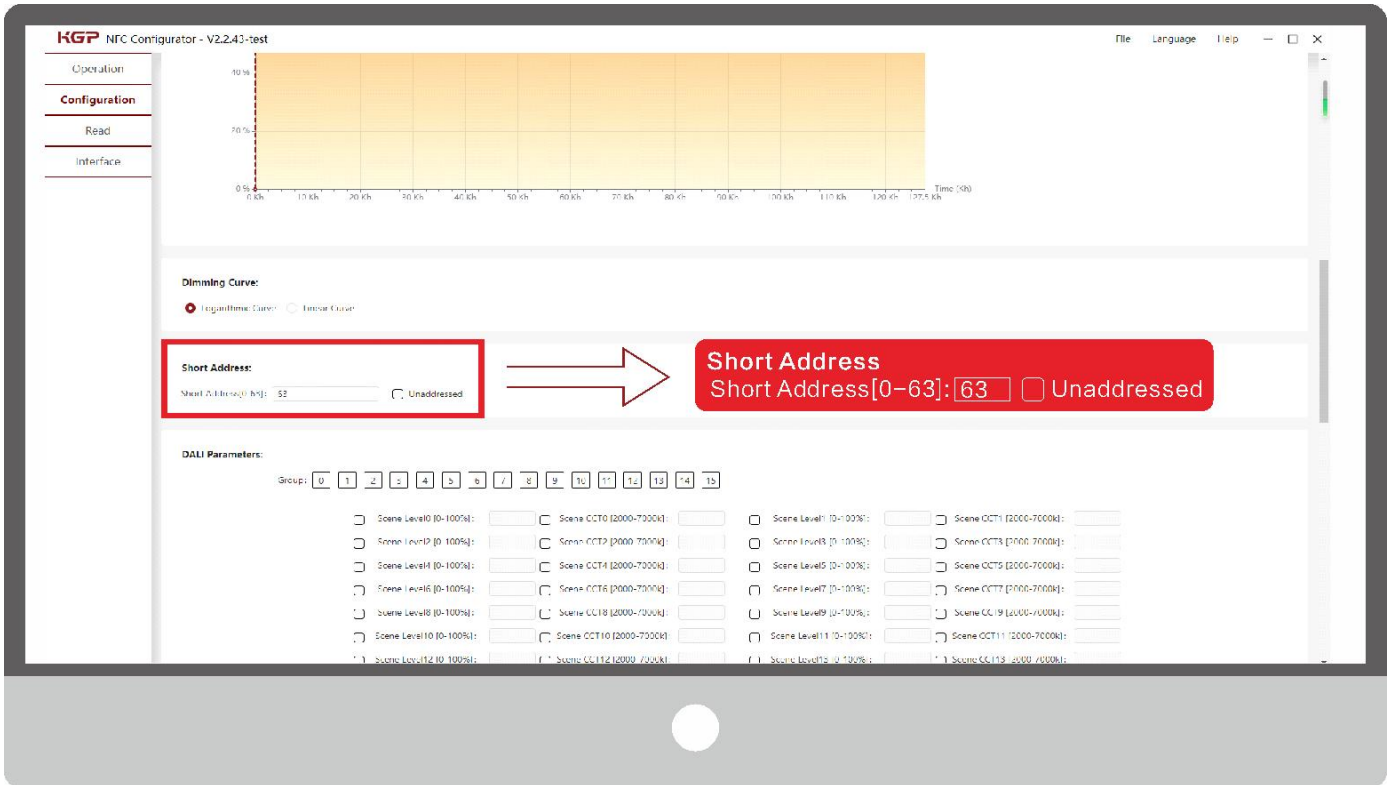

DALI Parameters setting:

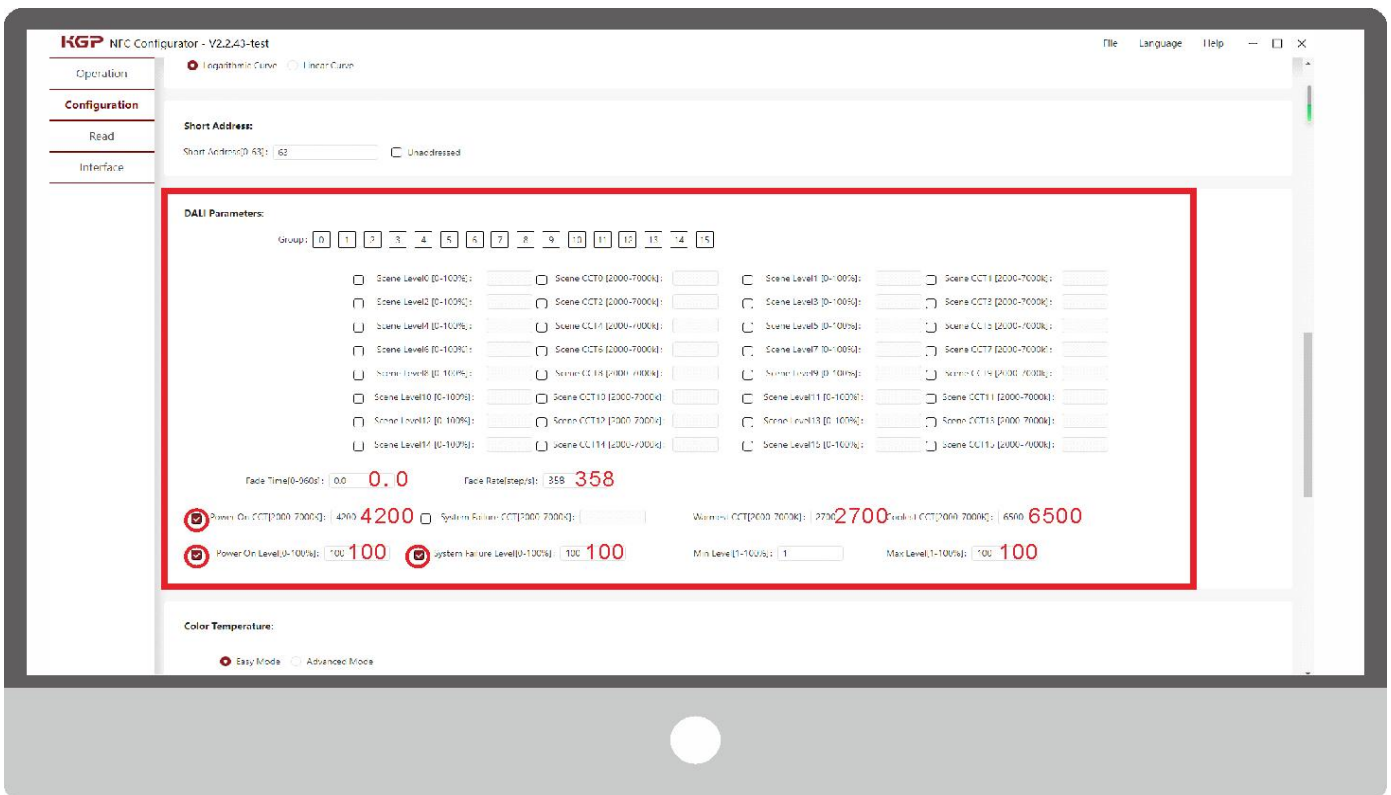

Color Temperature setting:

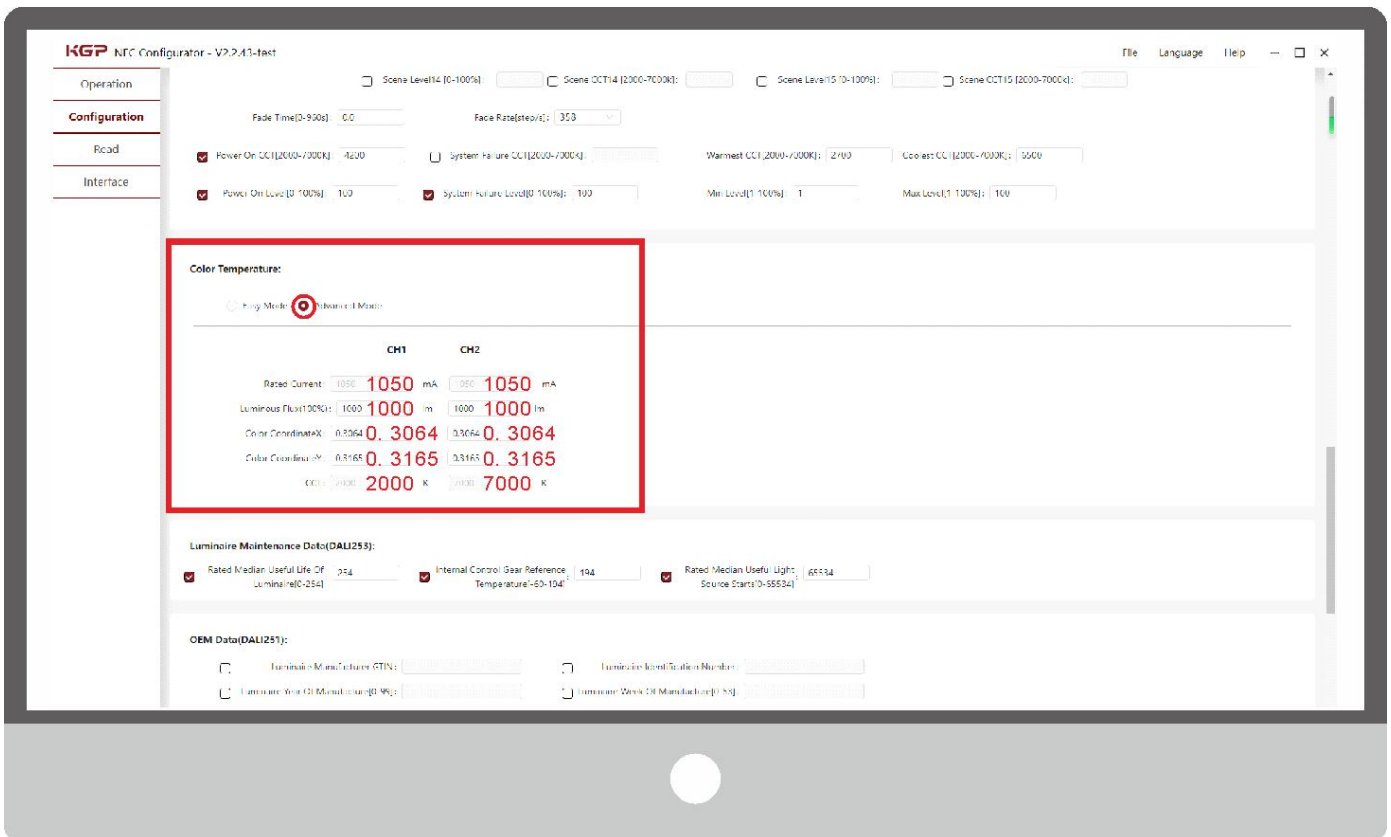
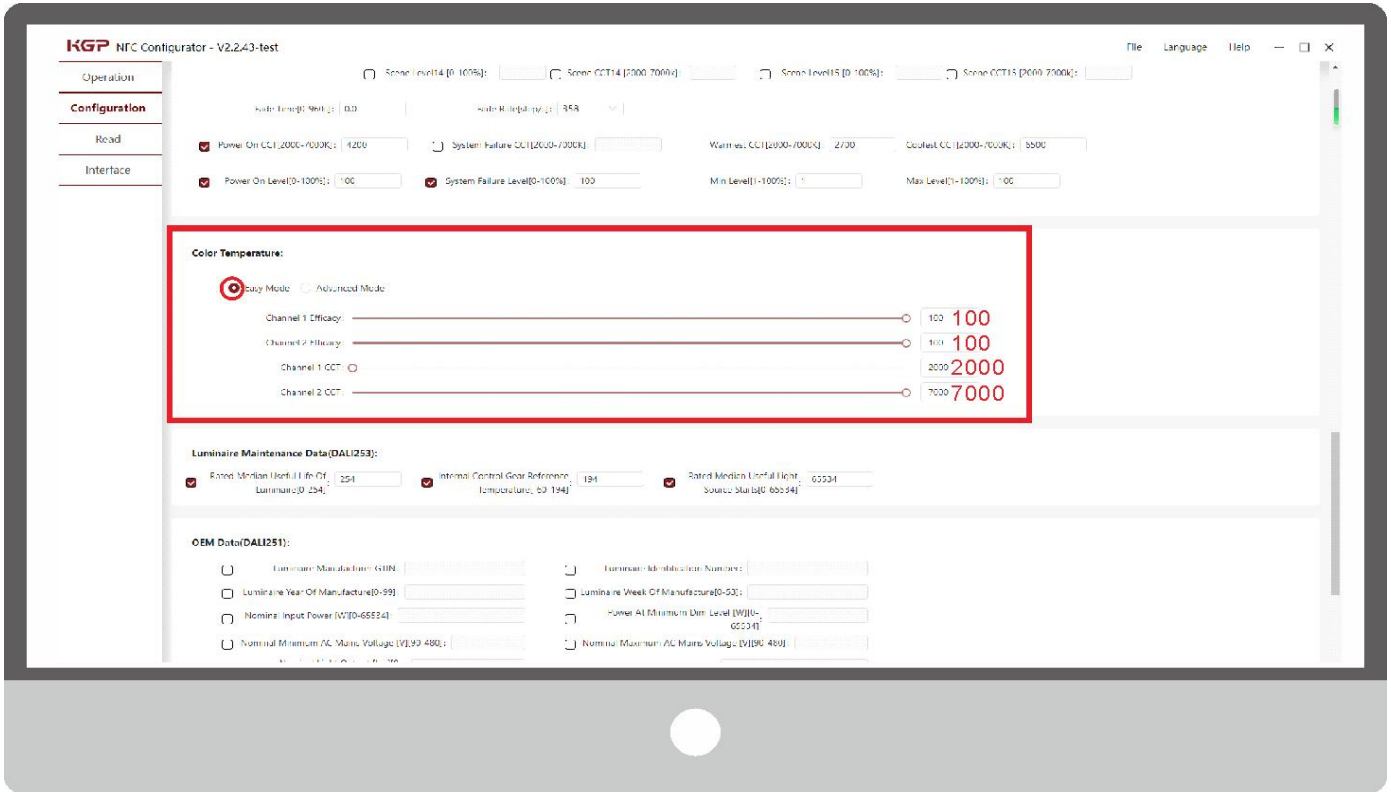

DALI 253 Parameter setting:

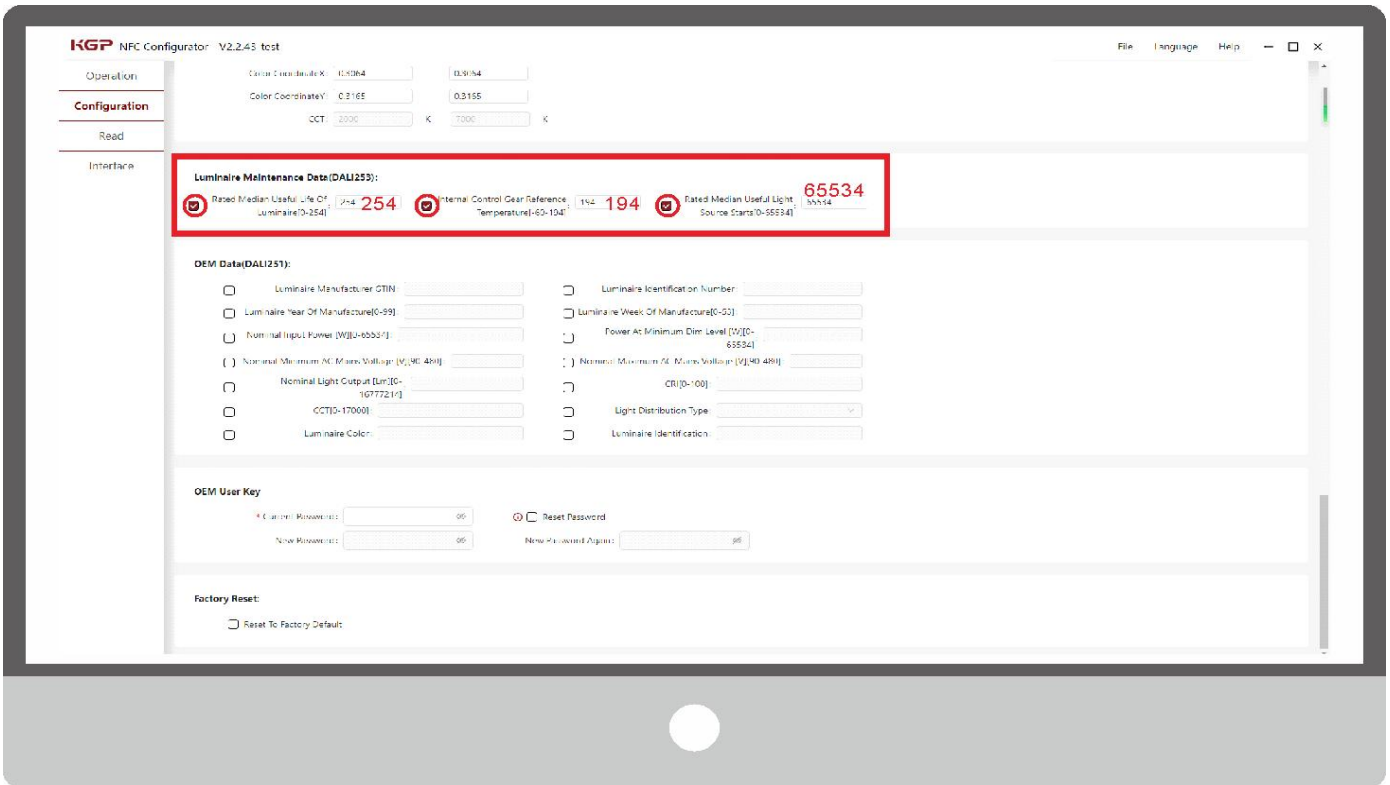

DALI 251 OEM Data setting:

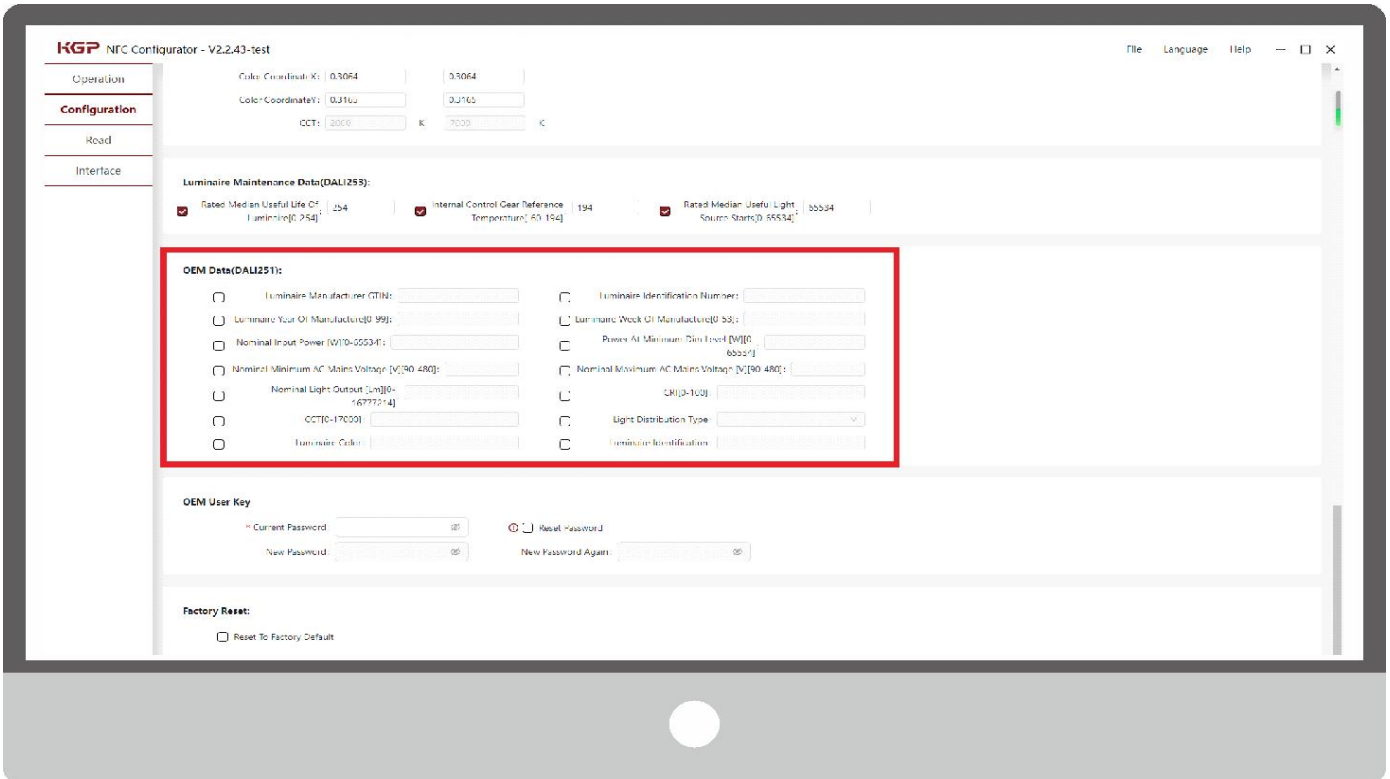

OEM User Key:

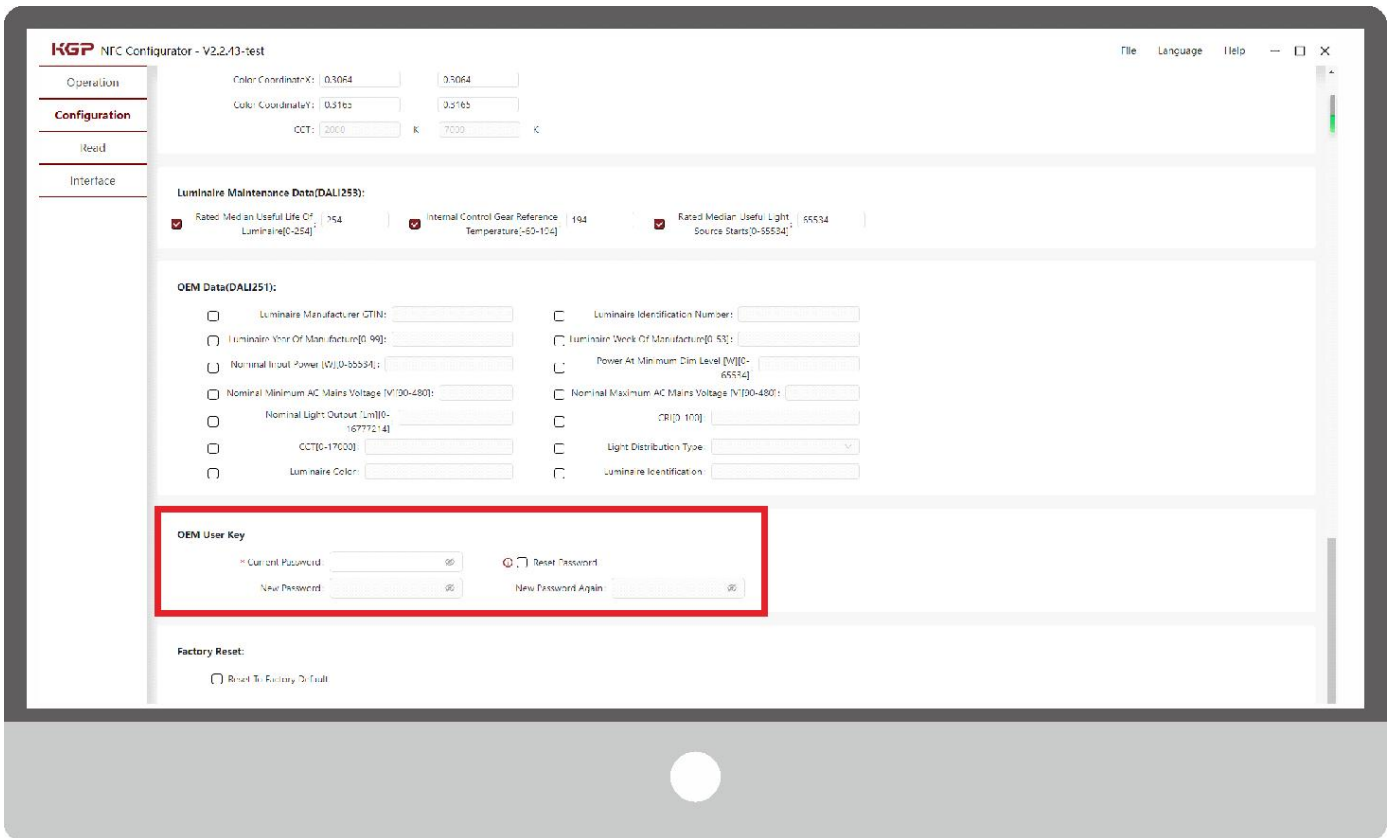

Factory Reset:

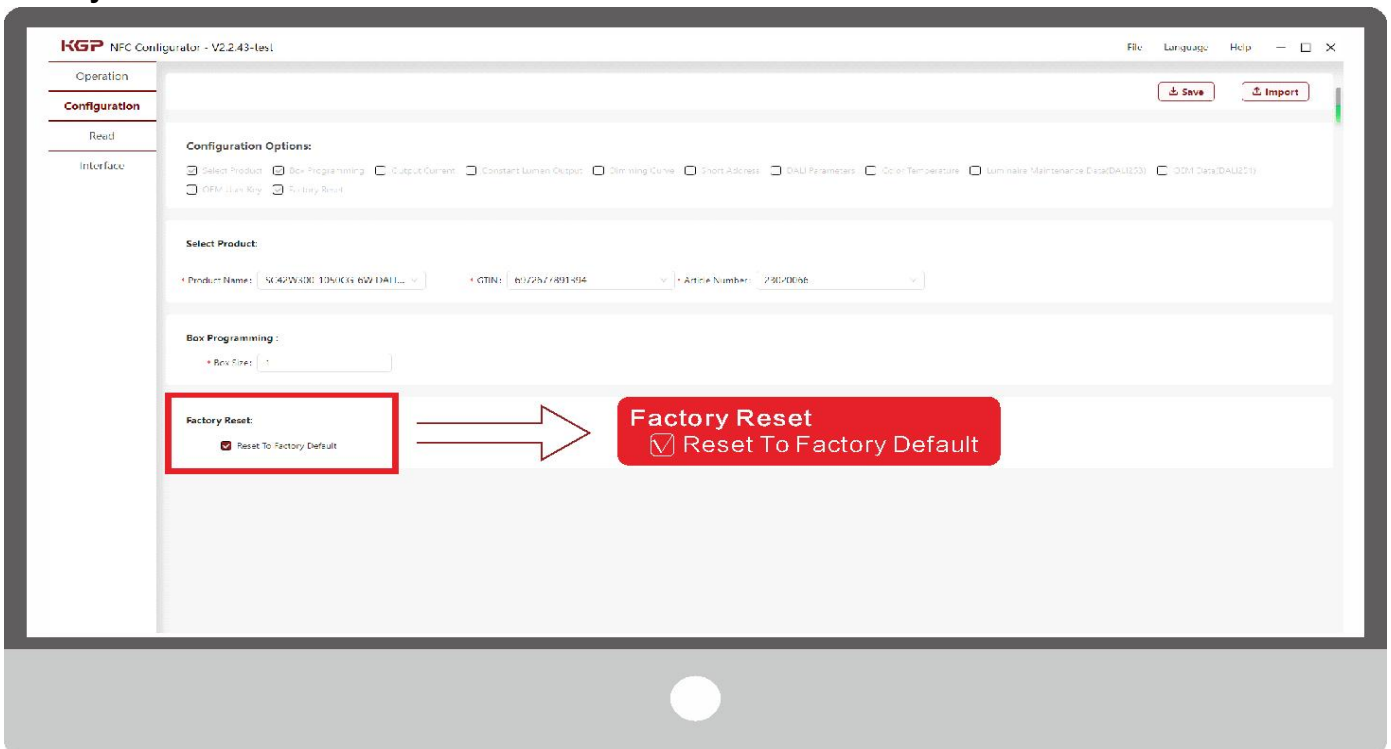

Step 4: Save the configuration file to a local directory

Click "Save" button to save the json file

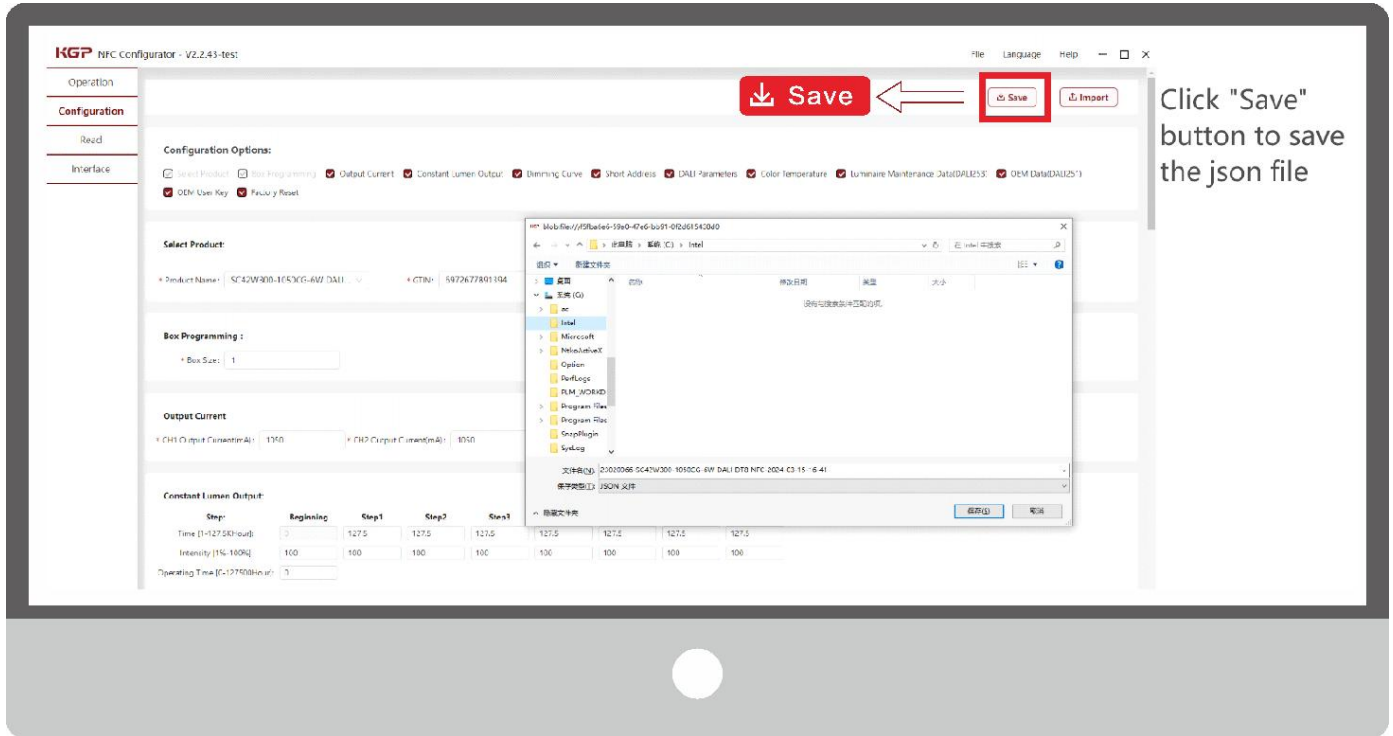

Step 5: Import configuration files for programming

Import the json file, check the product information

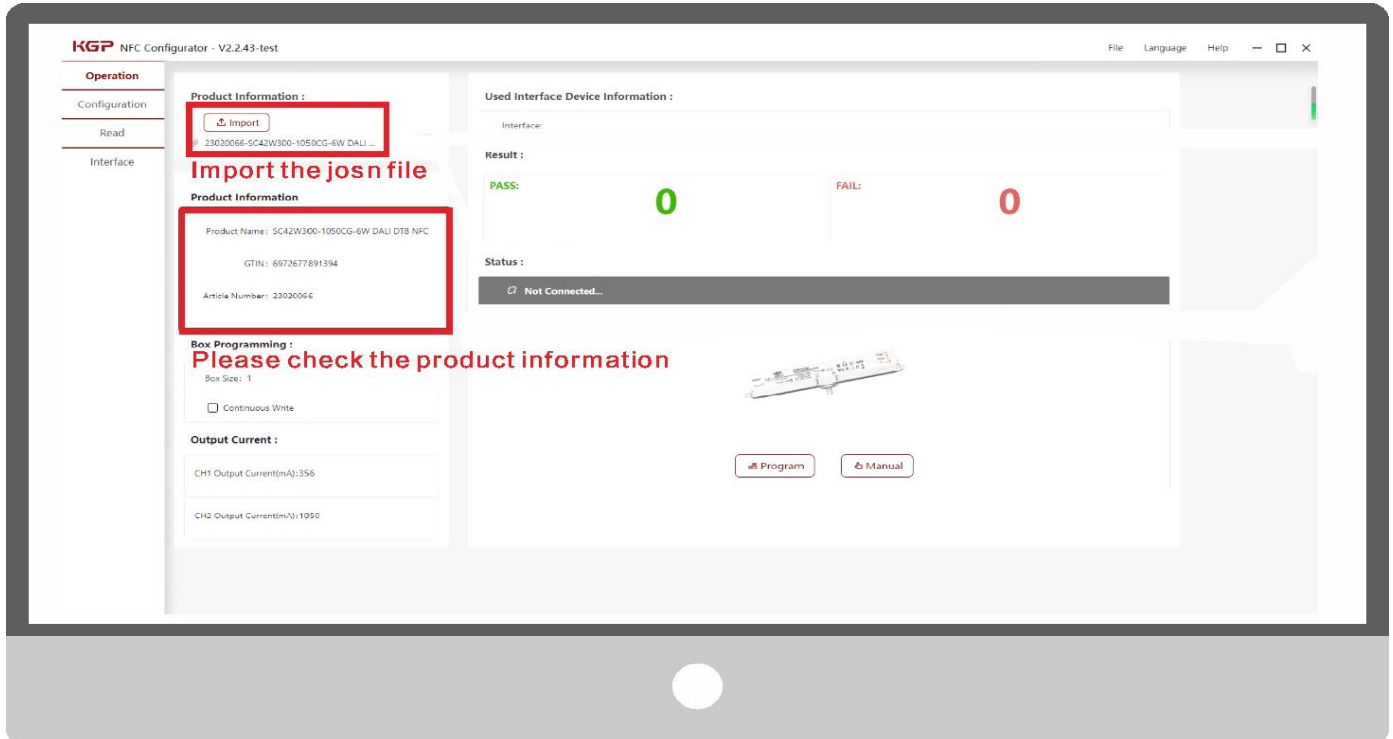

Click the “Program” button to write the program

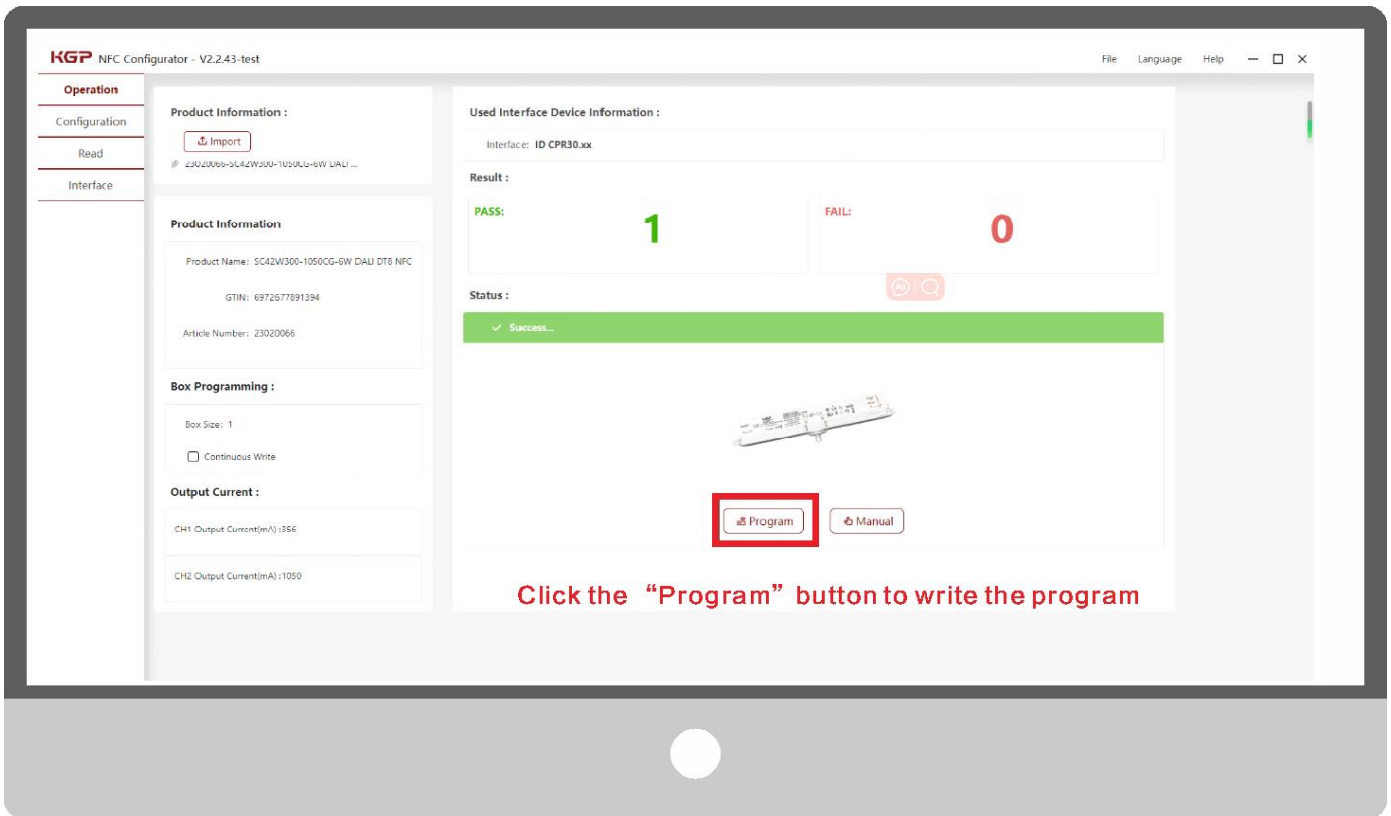

Step 6: Check that the parameters you just wrote are correct

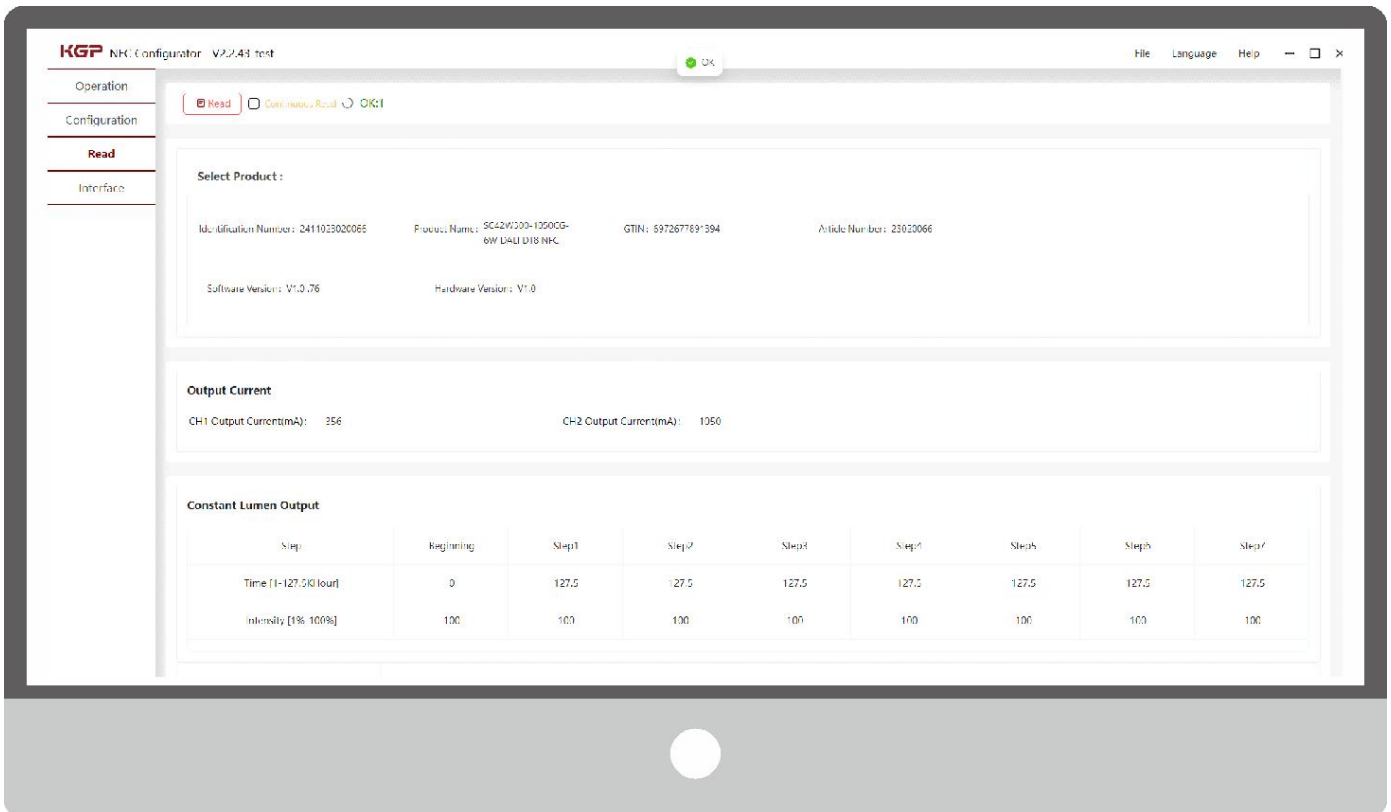

12. Mobile client:

Step 1: Download the APP (searching “KGP NFC” from App Store).

Then open the APP

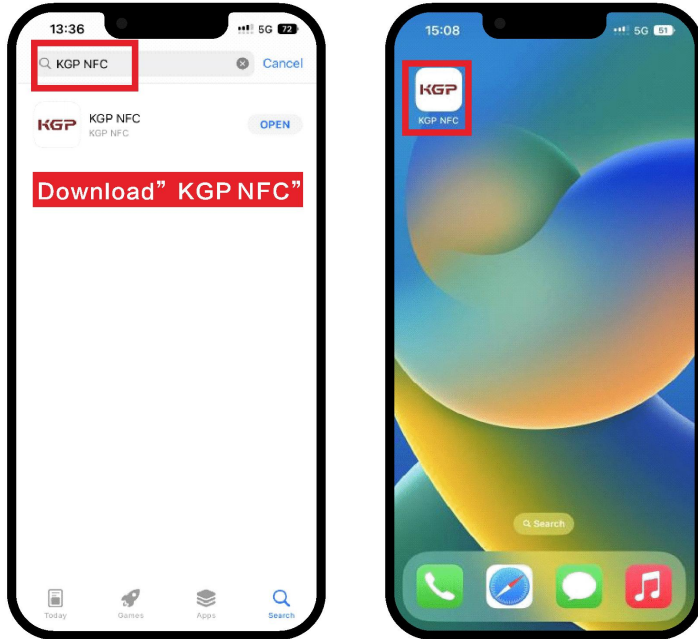

Note:

1. Please Make sure that you have enabled NFC function with your mobile phone/ tablet.
2. Please Make sure that the "NFC position" is matched.
3. Please do not power on the device before setting.

Step2: Enter the software and enter parameters configuring page.

- 1) Click “NFC” button Enter
- 2) Click the “Read” button to read
- 3) Check the product information

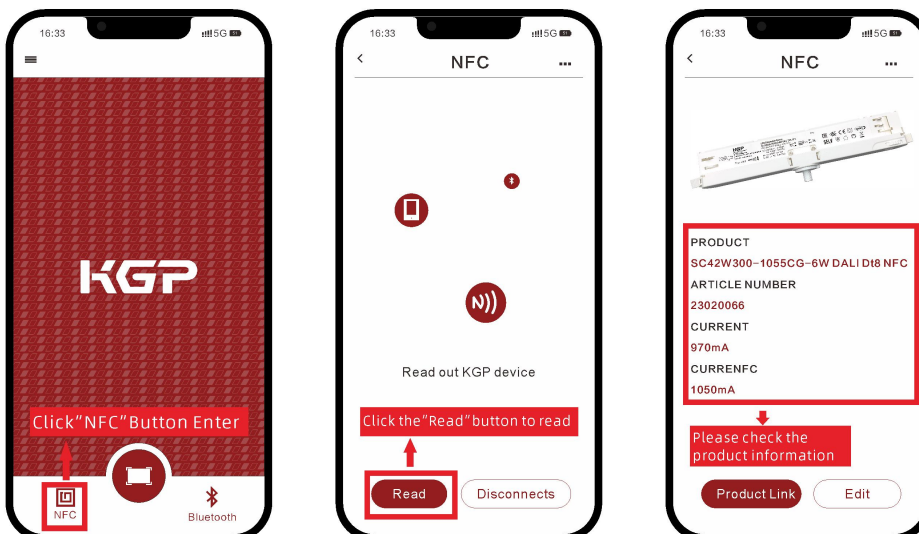

Step 3: Few parameter interface, you can choose the setting based on your requirements.

Click "Edit" button enter the page

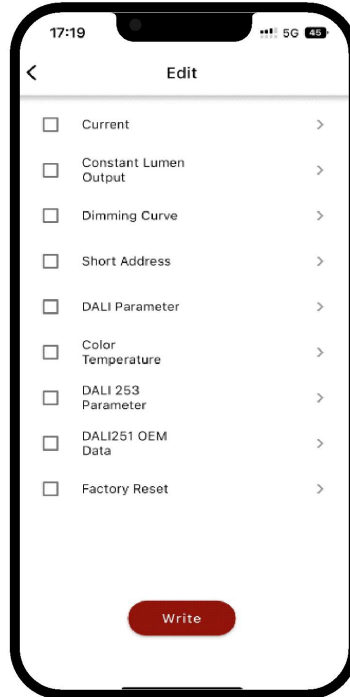
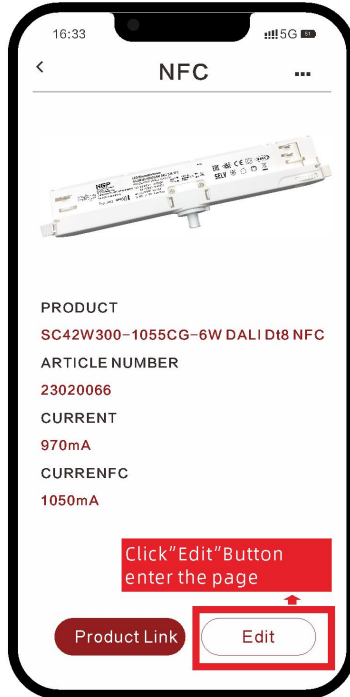

Output current setting:

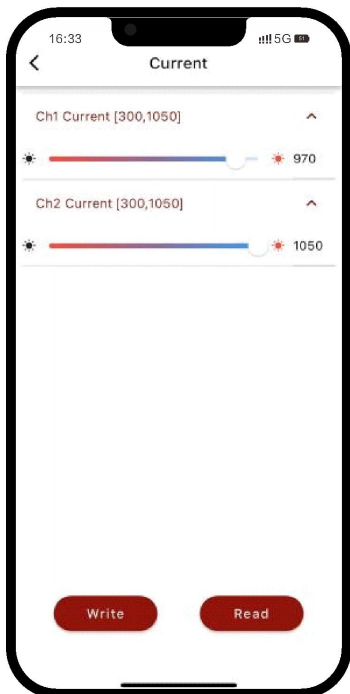
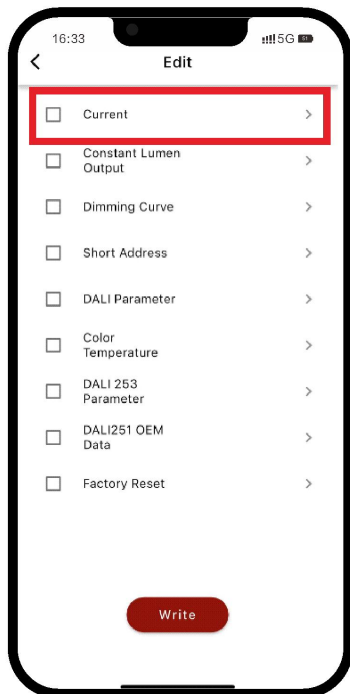

Enter CLO Setting:

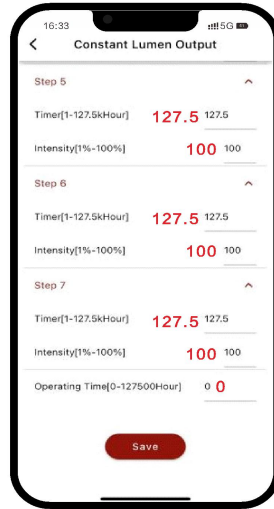
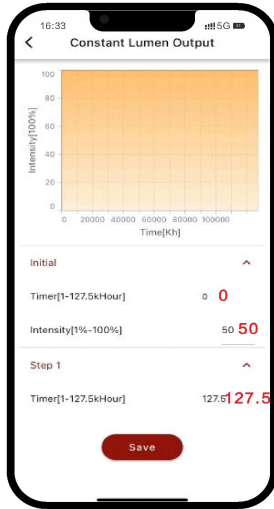
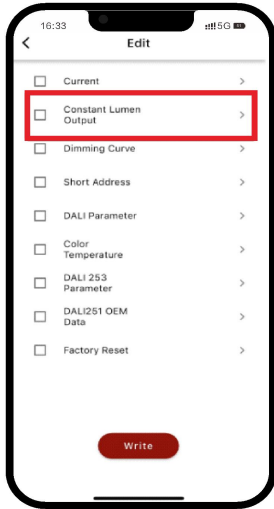

Dimming curve setting:

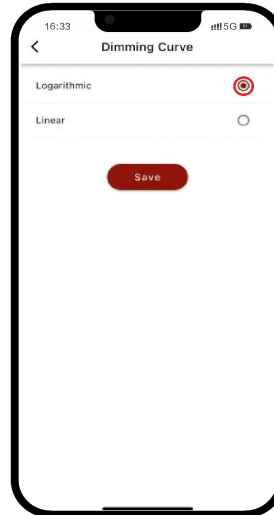
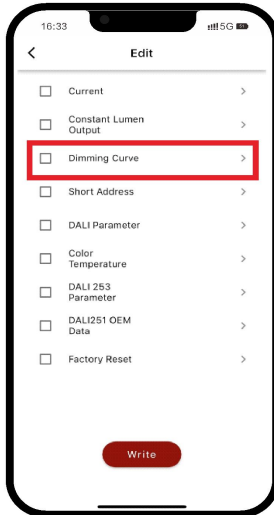

Assign Short Address:

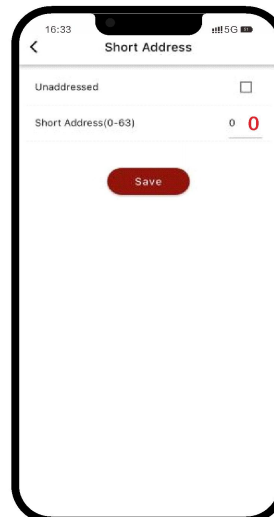
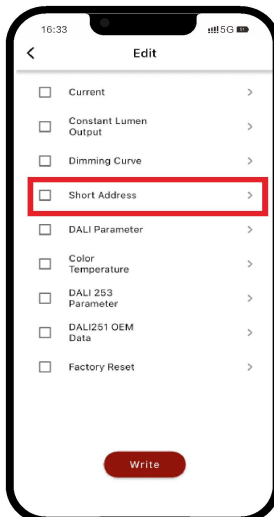

DALI Parameter setting:

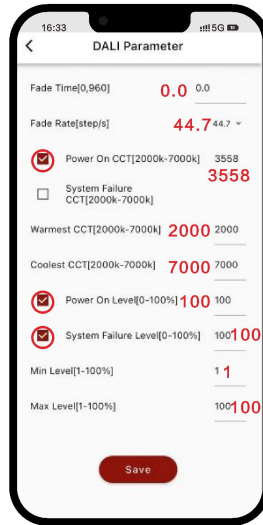
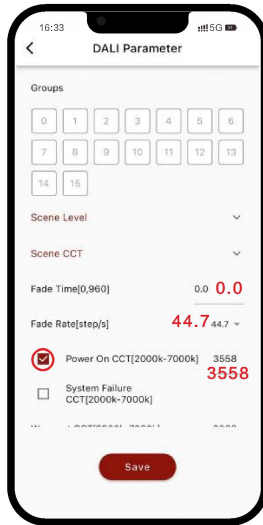
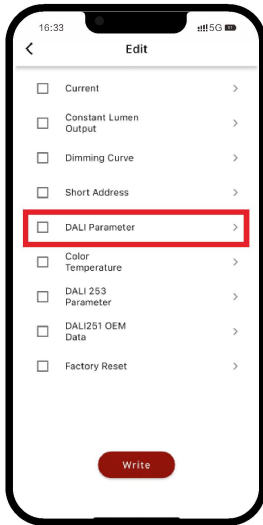

Color Temperature setting:

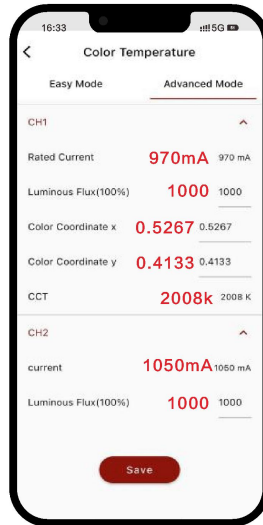
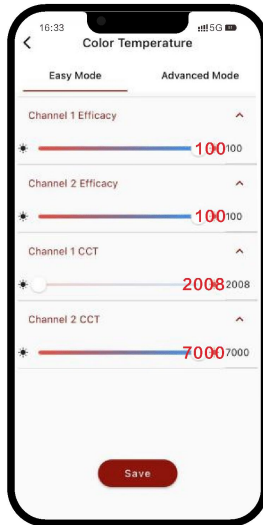
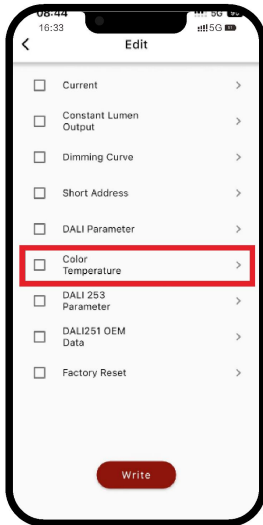

DALI 253 Parameter setting:

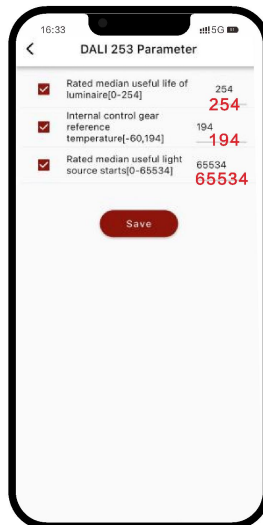
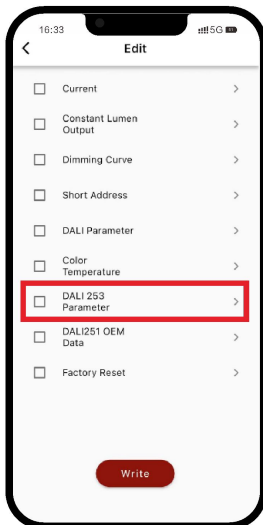

DALI 251 OEM Data setting:

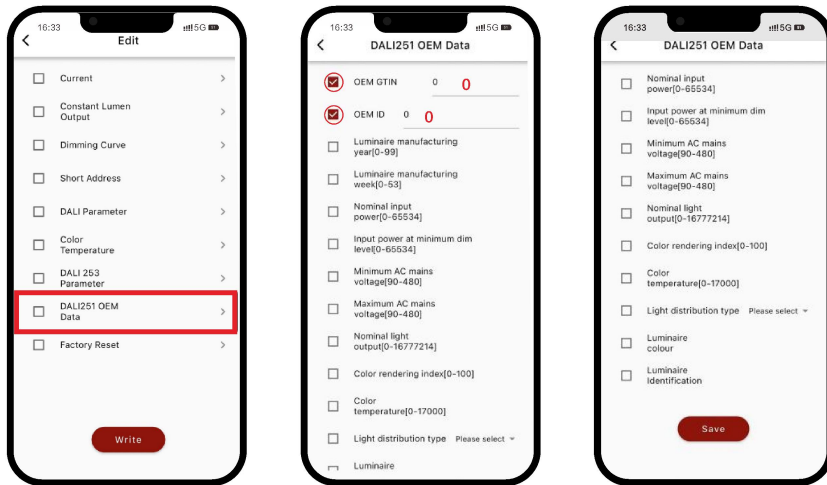

Factory Reset:

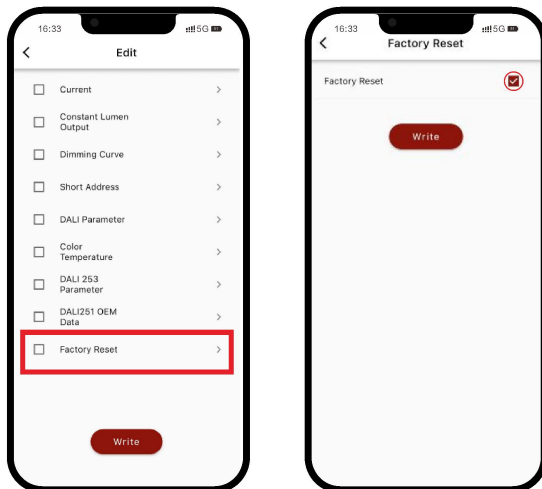

Step4 : After the configuration is complete, save the selected configuration using NFC, write the configuration, and power on the device

Click write Program

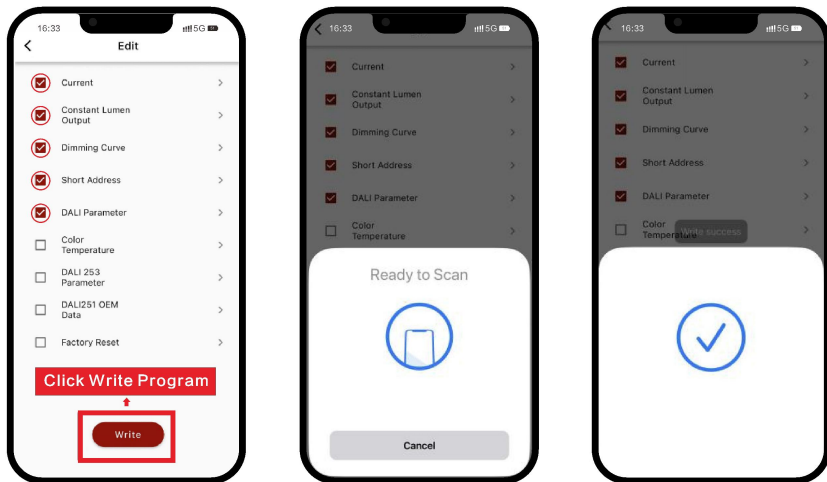

Tips:

- 1.NFC function doesn't require any power driver.
2. Many functions can be configured by NFC.Kindly check your desired functions.

13. Functions

16.1 OEM Identification

The OEM (Original Equipment Manufacturer) can set his own identification number.

DALI Part 251: Memory bank 1 extension.

16.2 OEM GTIN

The Original Equipment Manufacturer (OEM) can set his own Global Trade Item Number (GTIN).

DALI Part 251: Memory bank 1 extension.

16.3 Luminaire data

This function provides the asset management with accurate data about the luminaire.

DALI Part 251: Memory bank 1 extension.

DALI Part 253: Luminaire maintenance data.

16.4 LED current

The LED output current must be adapted to the connected LED module.

The value is limited by the current range of the respective device.

The output current of the LED driver can be adjusted in a certain range.

Adjustment is done by KGP Configurator via NFC.

16.5 Switch DIM

Integrated Switch DIM function allows a direct connection of a push button for dimming and switching.

Brief push (< 0.6 s) switches LED driver ON and OFF. The dim level is saved at power-down and restored at power-up.

When the push button is held, LED modules are dimmed. After repush the LED modules are dimmed in the opposite direction.

In installations with LED drivers with different dimming levels or opposite dimming directions (e.g. after a system extension), all LED drivers can be synchronized to 50 % dimming level by a 10 s push.

Use of push button with indicator lamp is not permitted.

16.6 Corridor FUNCTION

With the Corridor FUNCTION and a commercially available motion detector, it is easy to adapt the lighting in one area to its use.

That is, when the area is entered by a person, the lighting dims instantly to the desired brightness and is available in full strength.

After the area is left by the person, the brightness dims slowly to a smaller value or switches off completely.

The individual parameters of the desired profile, such as brightness values or delay times, can be adjusted flexibly and individually.

16.7 Constant Light Output (CLO)

With this function the light output of the LED module can be kept equal over the lifetime.

The light output of an LED module reduces over the course of its lifetime.

The Constant Light Output (CLO) function compensates for this natural decline by constantly increasing the output current of the LED driver throughout its lifetime.

CLO shall be achieved by limitation of the LED current at the commissioning of the LED driver and providing a linear interpolation of the current over the time, depending on the data points given by the user.

The user has to insert up to eight pairs of data (time, level).

The output curve is the result of connecting the user data points linear.

Detailed description for CLO see product manual.

The minimal CLO starting point is limited by the smallest output current of the LED driver.

16.8 Dimming curve

DALI: The desired dimming behaviour is selected via two different dimming curves (logarithmic or linear). DALI: The desired dimming behaviour is selected via two different dimming curves (logarithmic or linear).

The default setting of the dimming behaviour is logarithmic.

14. REVISION HISTORY

DATE	REV	Modification details
2024-07-24	V1.0	Initial release.