

Constant Current Dimmable Driver

Model: C42C300-1050N-2D



Model	Output Current	Input Current	Input Power	Output Power Range	PF	Efficiency	Output Voltage	No load Voltage
C42C300-1050N-2D	300mA	0.07A	15.4W	3.00-12.60W	0.86	85%	10-42V	59V
	350mA	0.08A	17.9W	3.50-14.70W	0.87	86%	10-42V	59V
	400mA	0.09A	20.5W	4.00-16.80W	0.88	87%	10-42V	59V
	450mA	0.10A	22.8W	4.50-18.90W	0.89	87%	10-42V	59V
	500mA	0.11A	25.3W	5.00-21.00W	0.90	87%	10-42V	59V
	550mA	0.12A	27.8W	5.50-23.10W	0.91	87%	10-42V	59V
	600mA	0.14A	30.4W	6.00-25.20W	0.92	89%	10-42V	59V
	650mA	0.15A	32.5W	6.50-27.30W	0.93	89%	10-42V	59V
	700mA	0.16A	35W	7.00-29.40W	0.94	90%	10-42V	59V
	750mA	0.17A	37.5W	7.50-31.50W	0.94	90%	10-42V	59V
	800mA	0.18A	40W	8.00-33.60W	0.95	90%	10-42V	59V
	850mA	0.18A	40W	8.50-34.00W	0.95	90%	10-40V	59V
	900mA	0.2A	42.4W	9.00-36.00W	0.96	90%	10-40V	59V
	950mA	0.2A	44.7W	9.50-38.00W	0.96	90%	10-40V	59V
	1000mA	0.23A	46.5W	10.00-40.00W	0.97	90%	10-40V	59V
1050mA	0.25A	48.8W	10.50-42.00W	0.97	90%	10-40V	59V	

* Test result @230V, 50Hz, Full Load.

1. Parameters

Category	Item	Technical Norm
Features	Output Type	Constant Current
	Dimming Type	DALI 2 DT8
	Output Features	Isolation
	IP Grade	IP20
	Insulation Class	Class II
Input	Rated Input Voltage	220-240VAC
	Range of Input Voltage	198-264VAC or 180-280VDC
	Frequency	50/60Hz
	Input Current	≤0.25A (230VAC, full load)
	Input Power	≤48.8W (230VAC, full load)



	Power Factor	≥0.97 (230VAC, full load)
	THD	≤10% (230VAC, full load)
	No-load Power Consumption	≤0.5W @230VAC
Output	Output Voltage Range	10-42VDC@300-800mA
		10-40VDC@850-1050mA
	No Load Voltage	59VDC Max.
	Output Current	300mA -1050mA (Max. output)
	Output Current Setting	1mA incremental adjustable output current(NFC)
	Max. Output Power	42W
	Efficiency	≥90% (230VAC, full load)
	Current Ripple(< 120 Hz)	±5% (Imax-Imin)/(Imax+Imin)
	PstLM	≤1
	SVM	≤0.4
	Current Accuracy	±5%
	Started Delay Time	≤1S(230VAC, full load)
Control Method	PUSH dimming terminal	PUSH dimming terminal (Max. lead wire length: 20m,same port of DALI)
	DALI function	DALI dimming (Max. lead wire length: 300m) Logarithmic or linear dimming curves are available DALI-2 certified incl. Parts 251, 252, 253 EL(EMI not evaluated),CLO,Corridor mode.
	Dimming range	DALI dimming: 1%-100% , Dim to off .
Protection	Short Circuit Protection	Auto Recovery
	Overload Protection	Auto Recovery
	No-load Protection	Auto Recovery
	Insulation voltage	3000V 5mA 60S between P-S
	Insulation resistance	>100M ohm @ 500VDC
	Leakage current	< 250μA, I/P to O/P or I/P to PE @230V input
Environment	Ta/Operation Temperature	-25....+45℃
	Ts/Storage Temperature	-35....+85℃
	Tc/Enclosure Temperature	85℃
	Humidity	10%....90%RH
	Atmosphere	86-108KPa
Construction	Connection Method	Push-in Terminal
	Installation	Independent
	PRI Wire preparation	0.5-1.5 [□]
	SEC Wire preparation	0.5-1.5 [□]
	Dimension	122.5*44*23mm (L*W*H)
Standards	Certification	ENEN、SAA、CE
	Safety Standards	EN 61347-1:2015/A1:2021,EN 61347-2-13:2014/A1:2017 EN IEC 62384:2020 ,EN 62493:2015/A1:2022, AS61347.2.13:2018, AS/NZS61347.1:2016 Inc A1
	EMC Standards	EN IEC 55015:2019,EN IEC 55015:2019/A11:2020



		EN IEC 61000-3-2:2019/A1:2021, EN 61000-3-3:2013/A2:2021 EN IEC 61547:2023
	RED Standards	EN 301 489-1 V2.2.3, EN 301 489-17 V3.2.4 EN 300 328 V2.2.2, EN 50663:201, EN 300 330 V2.1.1:2017 EN 301 489-1 V2.2.3:2019, EN 301 489-3 V2.3.2:2023 EN 62479:2010, EN 50663:2017
	Performance	EN62384
	Surge	L-N/2KV
Others	RoHS	complied to 2011/65/EU
	Life Time	50000h @Ta/ Tc
	Warranty	5years , F.R. < 10000ppm
	Audible Noise	<22dB @ 20cm distance, 15dB background

Remark:

- 1.All Parameters, if not specified, are measured at 230VAC/50Hz and 25°C ambient temperature.
- 2.LED Driver is a component of the luminaires, Luminaires and wire layout will affect the EMC, please check the EMC with end products again.

2. Connected quantities of different current Breaker

TYPE	Connected quantities of different current Breaker						Input Voltage	Inrush Current	Time
	current (A)	10	13	16	20	25			
	Installation wire diameter	1.5mm ²	2.5mm ²	2.5mm ²	4mm ²	4mm ²			
TYPE B	9	11	14	17	22	@230VAC	68.8	4.5	
TYPE C	14	18	22	28	35				
TYPE D	22	29	36	45	56				

3. Label



C42C300-1050N-2D
Constant Current LED Dimmable Driver
 PRI:220-240VAC 50/60Hz 0.25A Max.
 SEC:300-1050mA 10-42VDC No Load:59VDC Max.42W
 ta:-20...45°C tc:85°C For LED modules Only

wire preparation 8-9mm
 PRI:0.5-1.5"
 DALI:0.5-1.5"
 SEC:0.5-1.5"

SEC
 CW WW + ●
 - ●
 + ●
 - ●

DIM
 ● L
 ● N
 ● DA
 ● DA





4. Electrical values

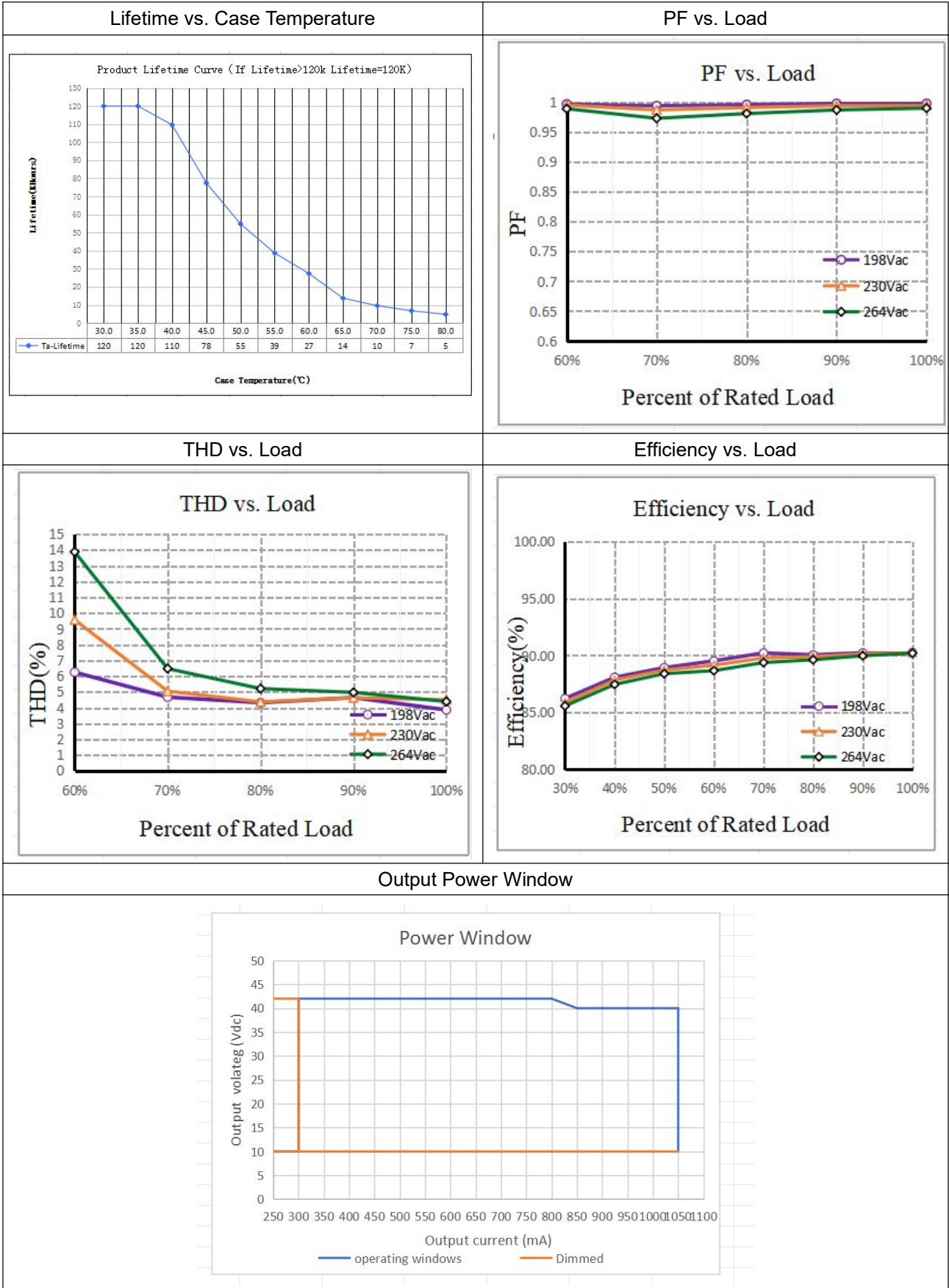

5. DALI dimming curve

formula for DALI dimming.

$$X(n)=10^{\{[(n-1)/(253/3)]-1\}}$$

Here, n means the target dimming stage of the total 254 stages.

X(n) means the percent of the maximum output current

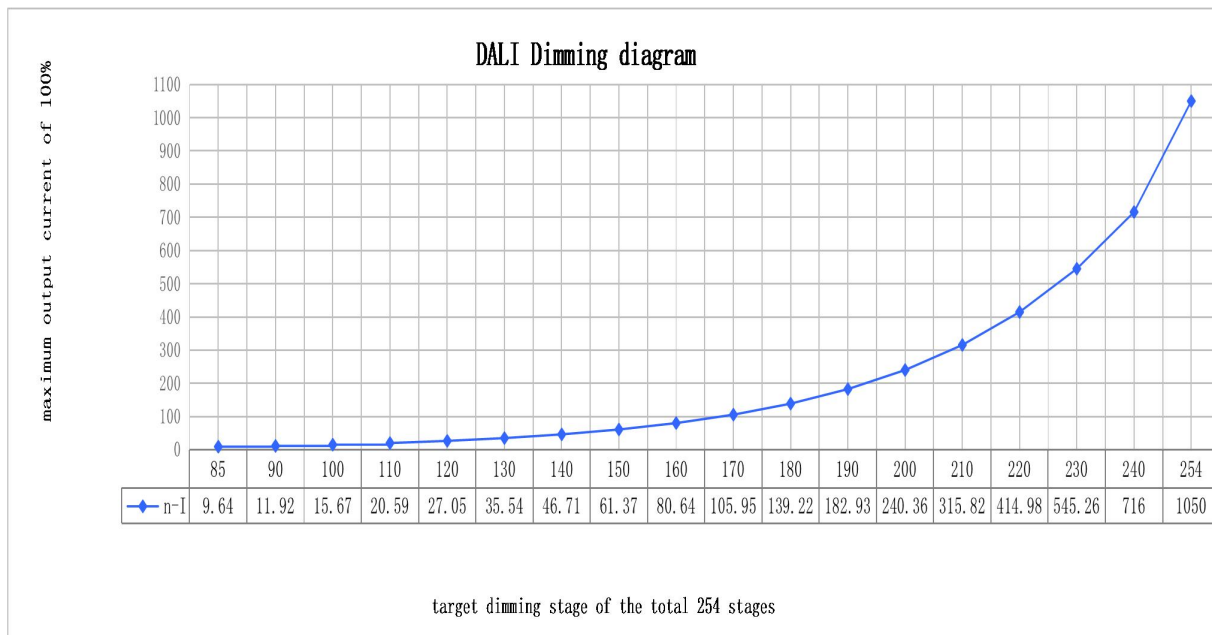

6. Dimension

A

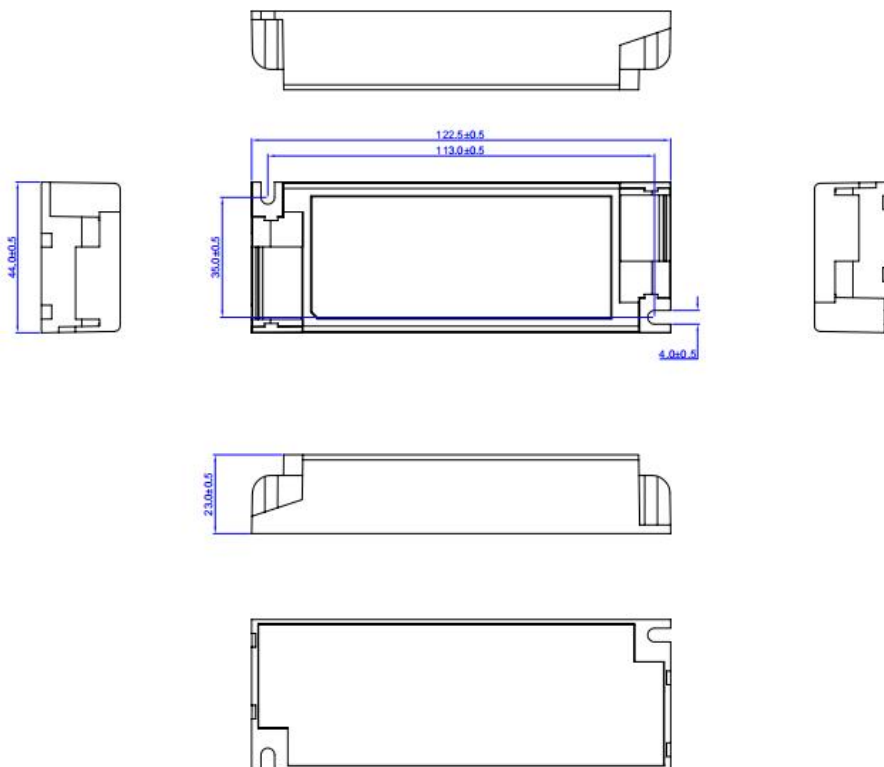

B

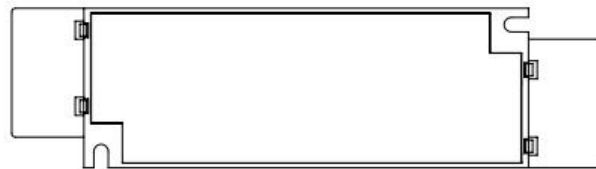
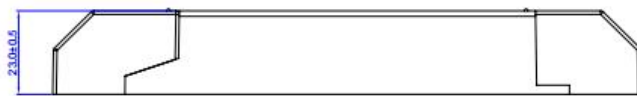
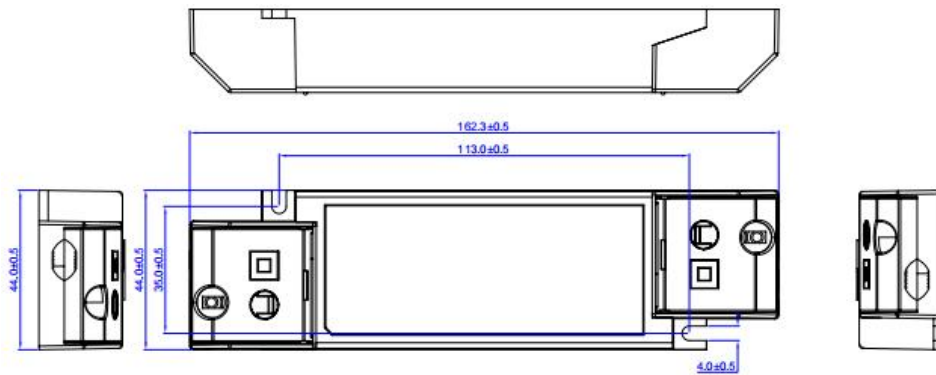

C

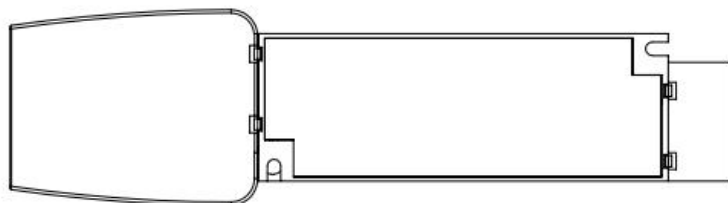
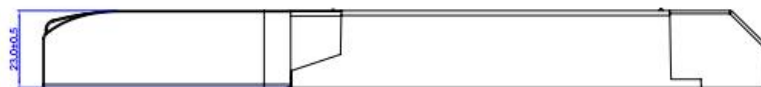
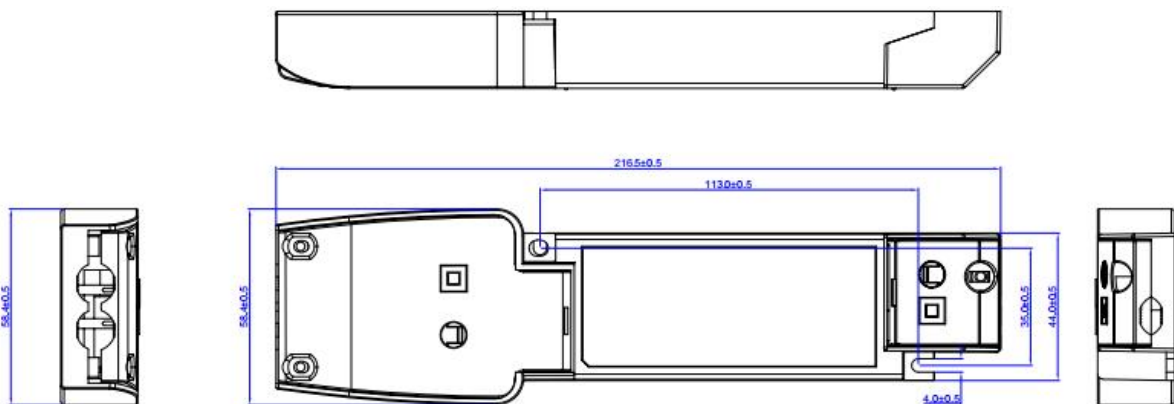

7. Packing information

SC(A)

Packing way	Model	Carton L*W*H(mm)	Pcs/ Carton	Net weight/ Pcs(kg)	Net weight/ Carton(kg)	Gross weight/ Carton(kg)
industrial	C42C300-1050N-2D	245*260*220	60	0.170	10.2	11.65

8. Wiring Diagram

Fig. A: Push Dimming

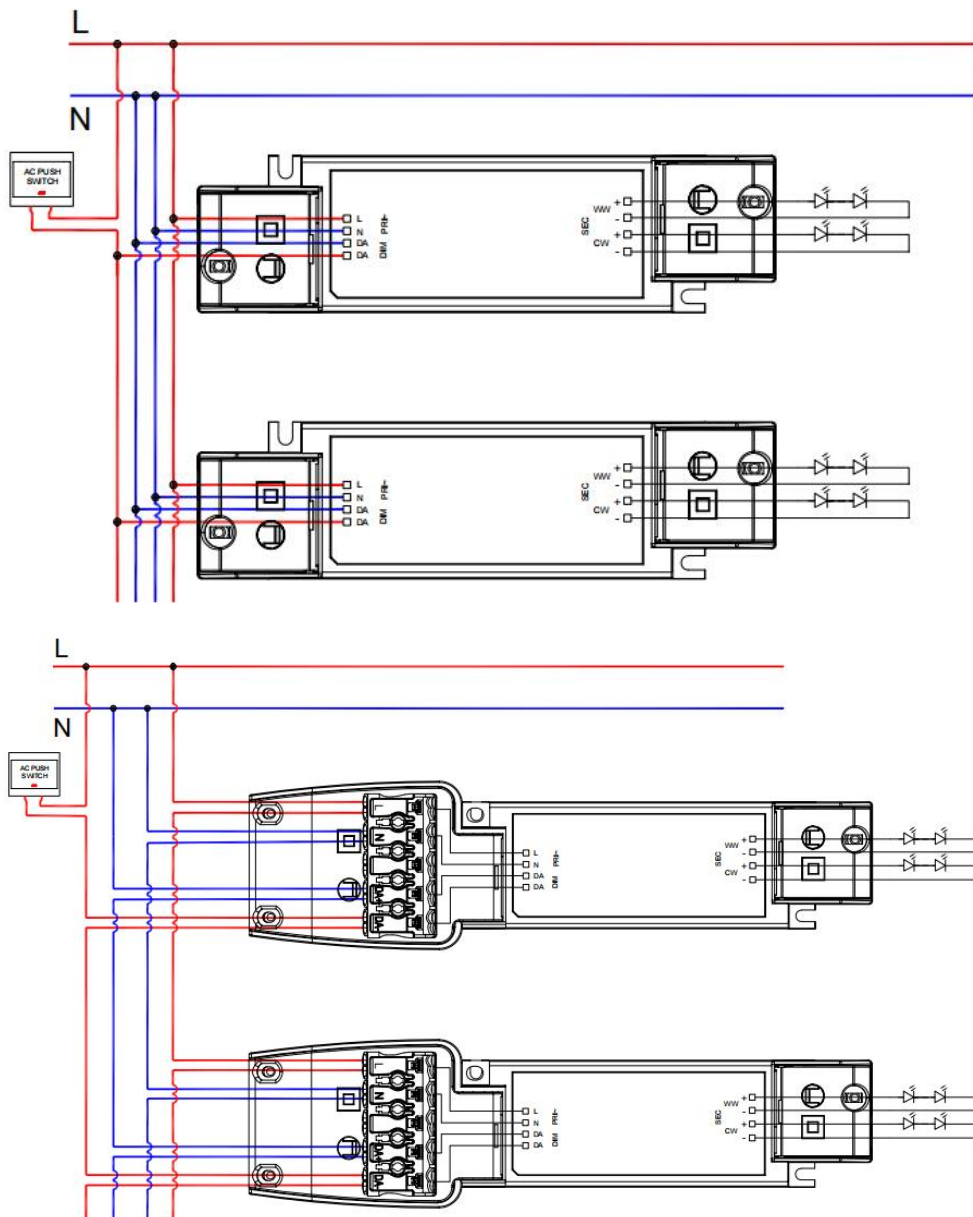
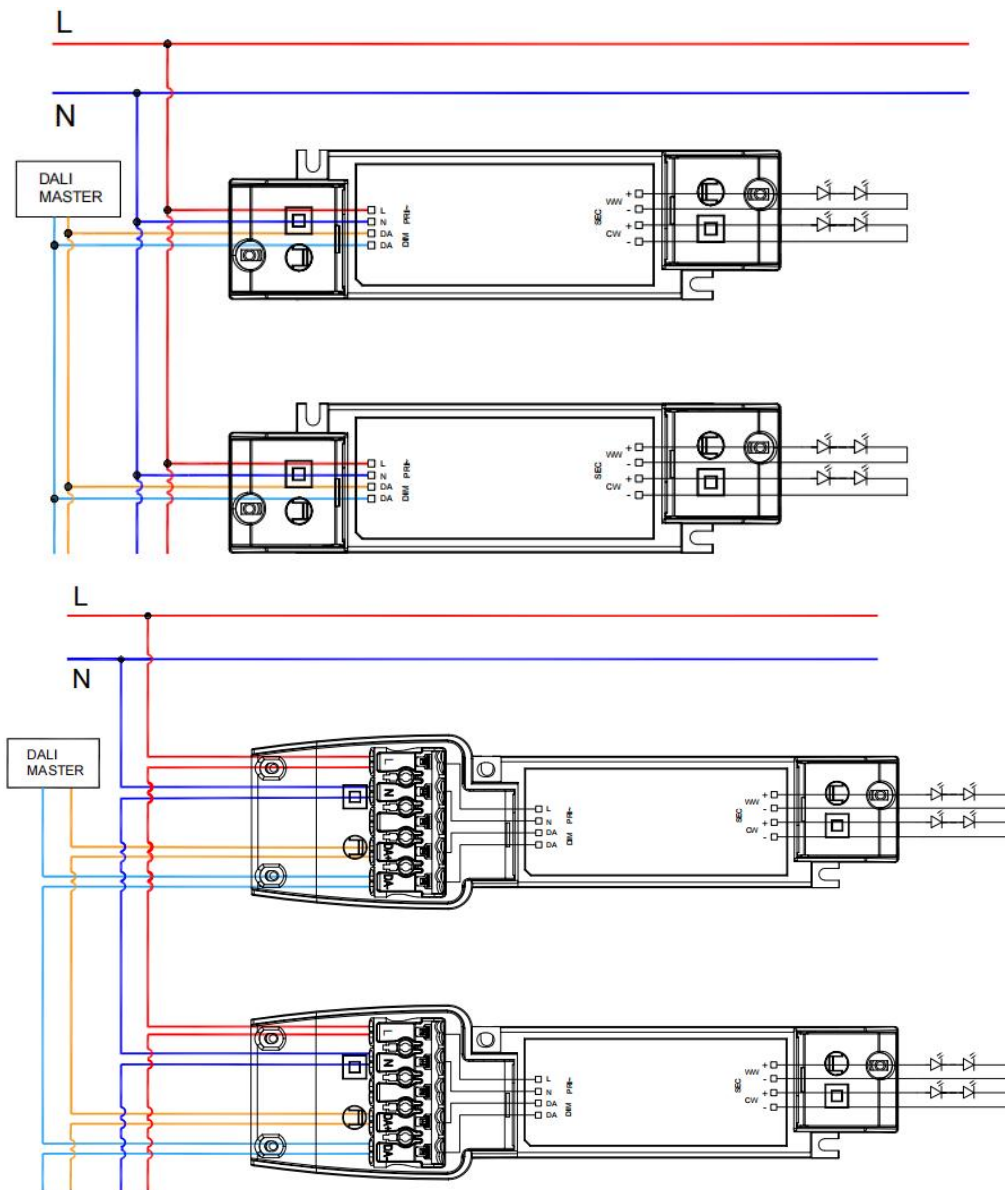

Fig. B: DALI Dimming



9. Wiring instructions

- All connections must be kept as short as possible to ensure good EMI behaviour
- Mains leads should be kept apart from LED Driver and other leads (ideally 5 – 10 cm distance)
- Advice the maximum length of output wires is 3 m
- Secondary switching is not permitted (Except for constant voltage)
- Incorrect wiring can damage LED modules.
- The wiring must be protected against short circuits to earth (sharp edged metals parts, metal cable clips, louver, etc.)



10. Replace LED module

- Mains off
- Remove LED module
- Wait for 30 seconds
- Connect LED module again

Hot plug-in or secondary switching of LEDs is not permitted and may cause a very high current to the LEDs

11. NFC instructions

REMARK:

You are advised to set DALI parameters when the power supply is not enabled





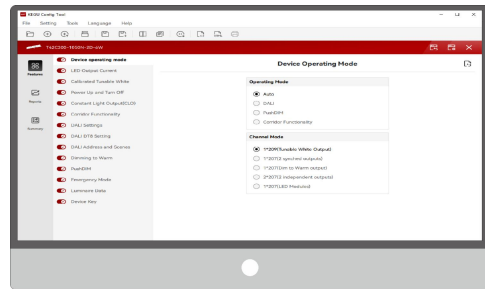

Make sure your computer has NFC capability and has it activated.

NFC Reader (optional)

Feature:

Easily on-line read a output current from a driver or write a new current data to a driver throughout KGP NFC reader within few seconds.



Product	Description	Interface	Matching antenna	Zhaga approval	Usage
 ID CPR30+	Desktop programmer	USB	Integrated	Yes	Single Programming on Desktop
 ID ISC.PRH101-USB	Handheld programmer	USB	Integrated	Yes	Single Programming by Handheld
 ID ISC.MR102-USB	Middle range programmer , for connecting external antenna	USB	RF-MANT12786 	Yes	Single Programming on Product line
 ID ISC.LR1002-E	Long range programmer , for connecting external antenna	USB,RS232,TCP/IP	ID ISC.ANT310/310 	Yes	Multi Programming System



Step 1: Connect FEIG reader

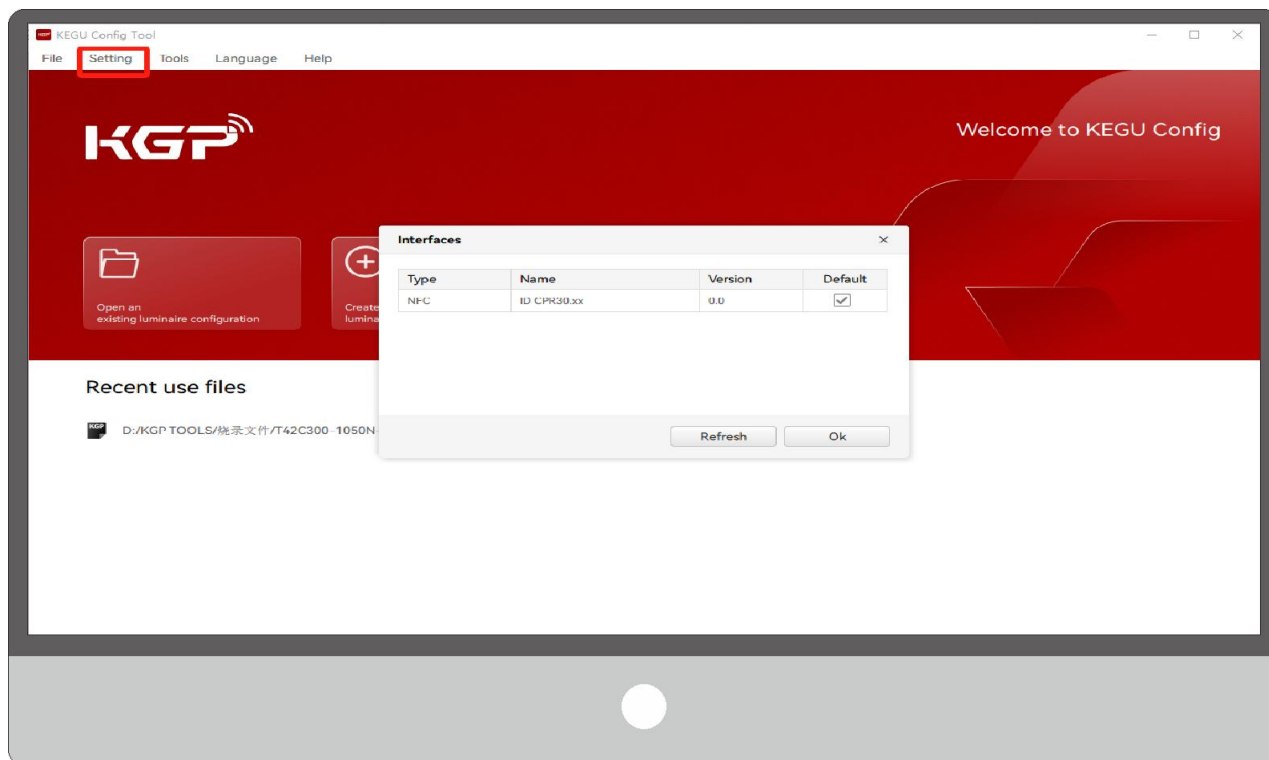

Step 2: Read product information

Click this button to read

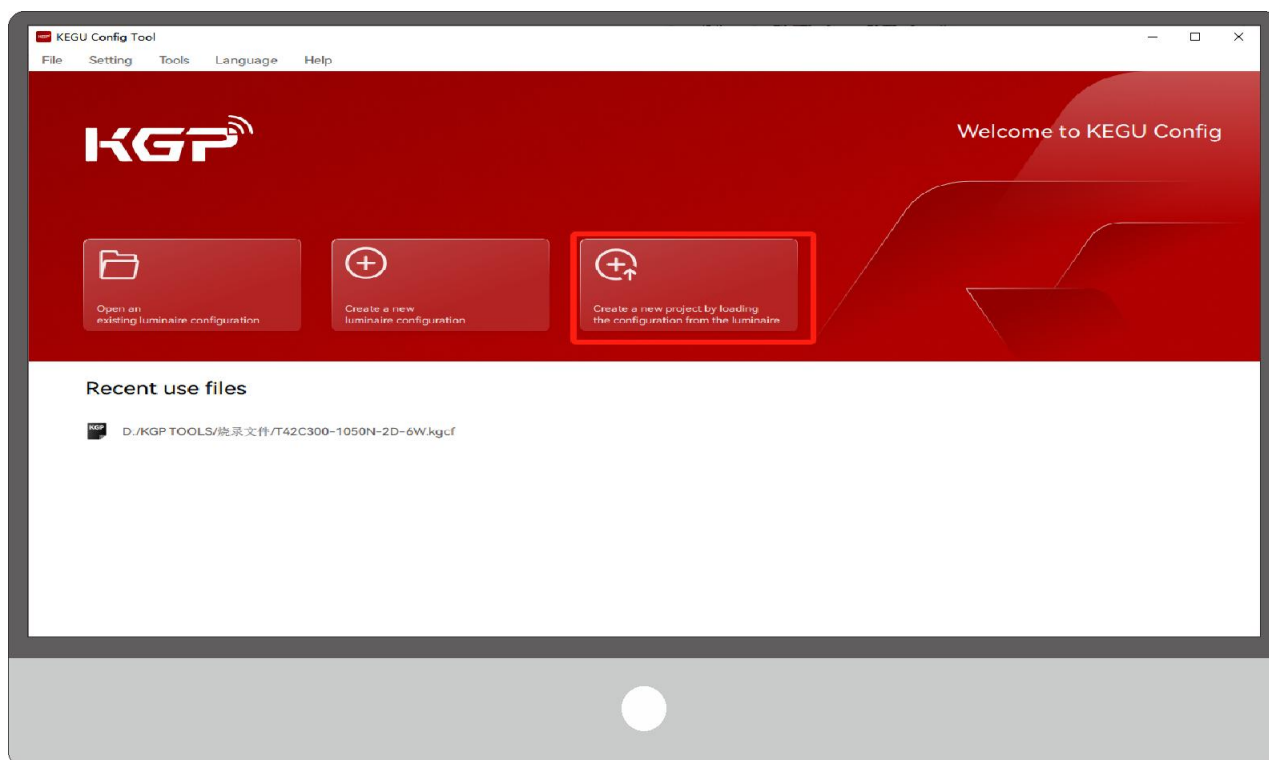

Step 3: Few parameter interface, you can choose the setting based on your requirements.

Device operating mode

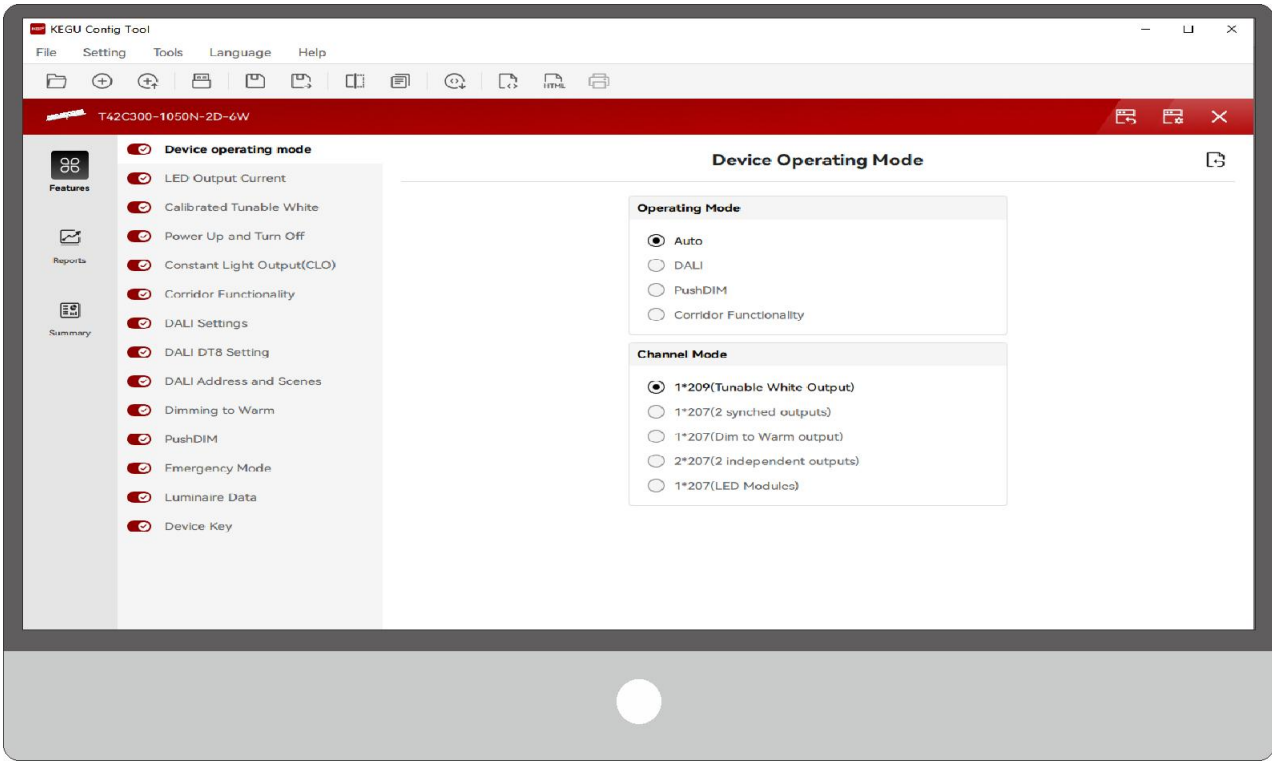

LED Output Current

Enter the output current value you want to change in the inputbox

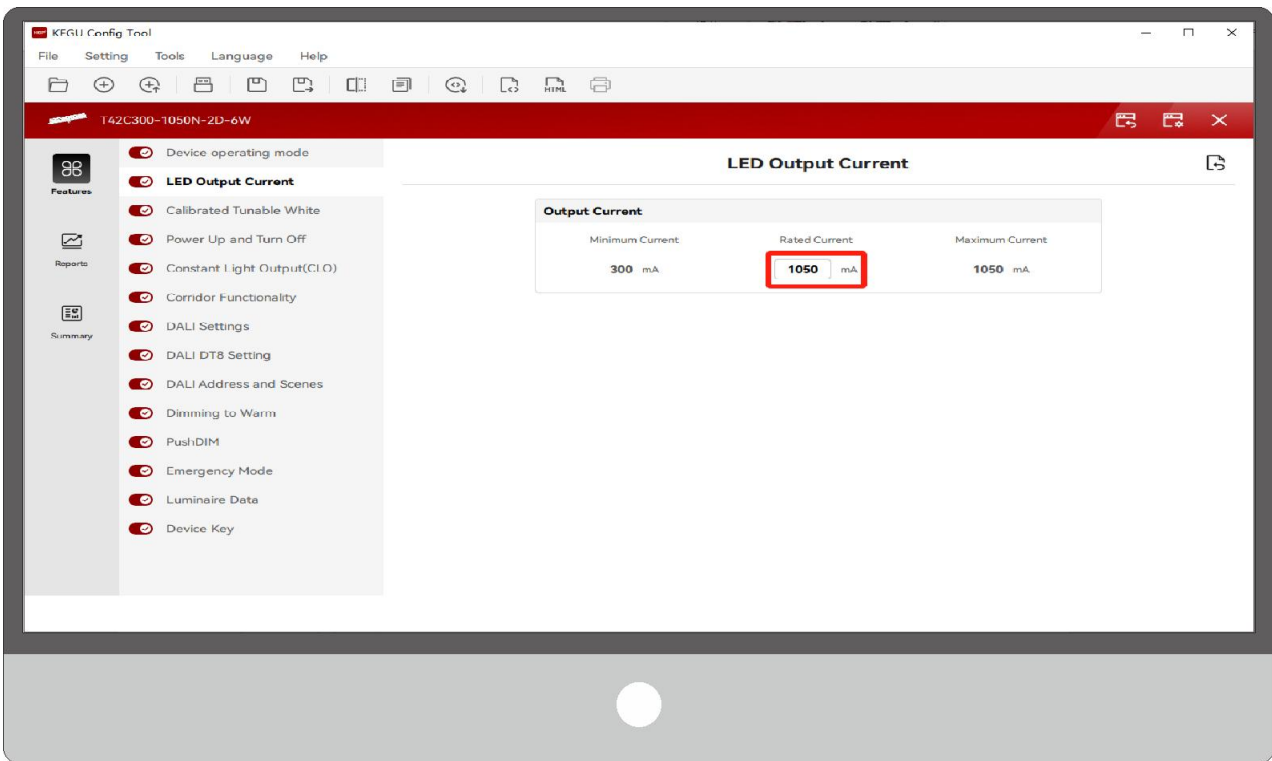

Calibrated Tunable White

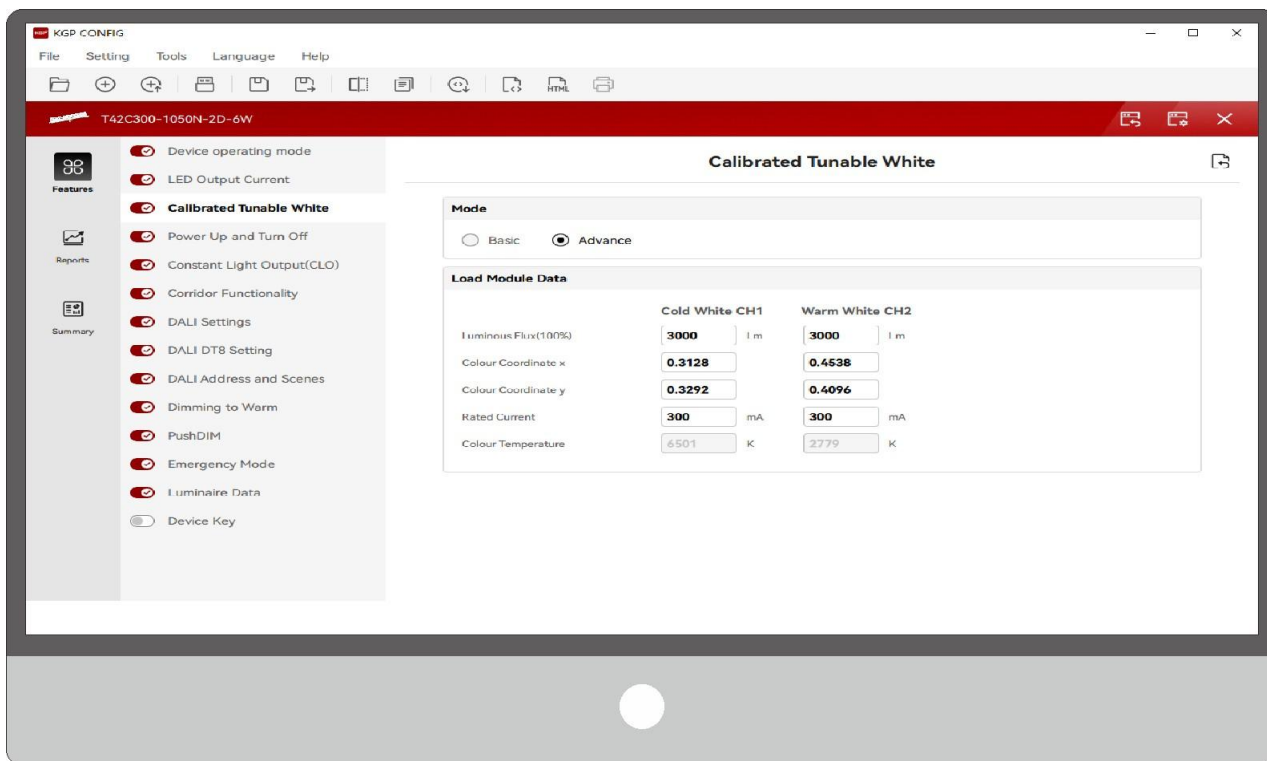

Power Up and Turn Off

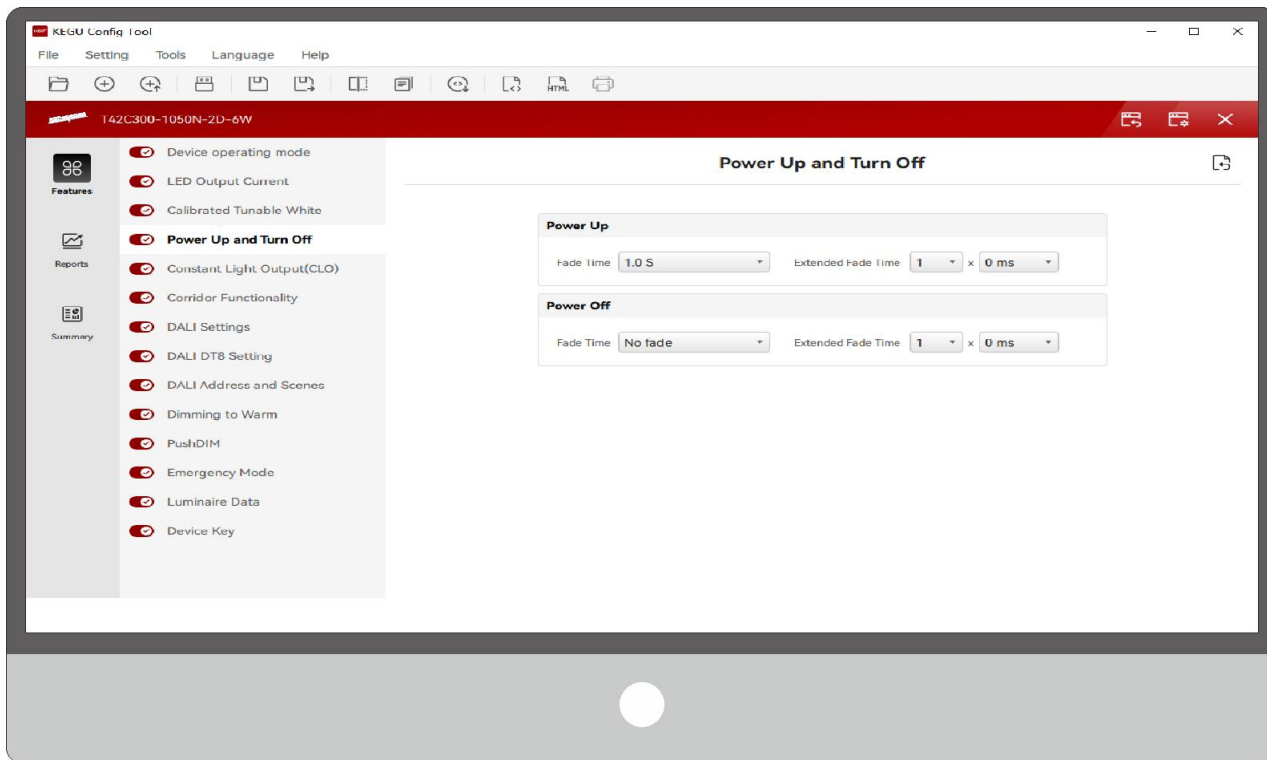

Constant Light Output(CLO)

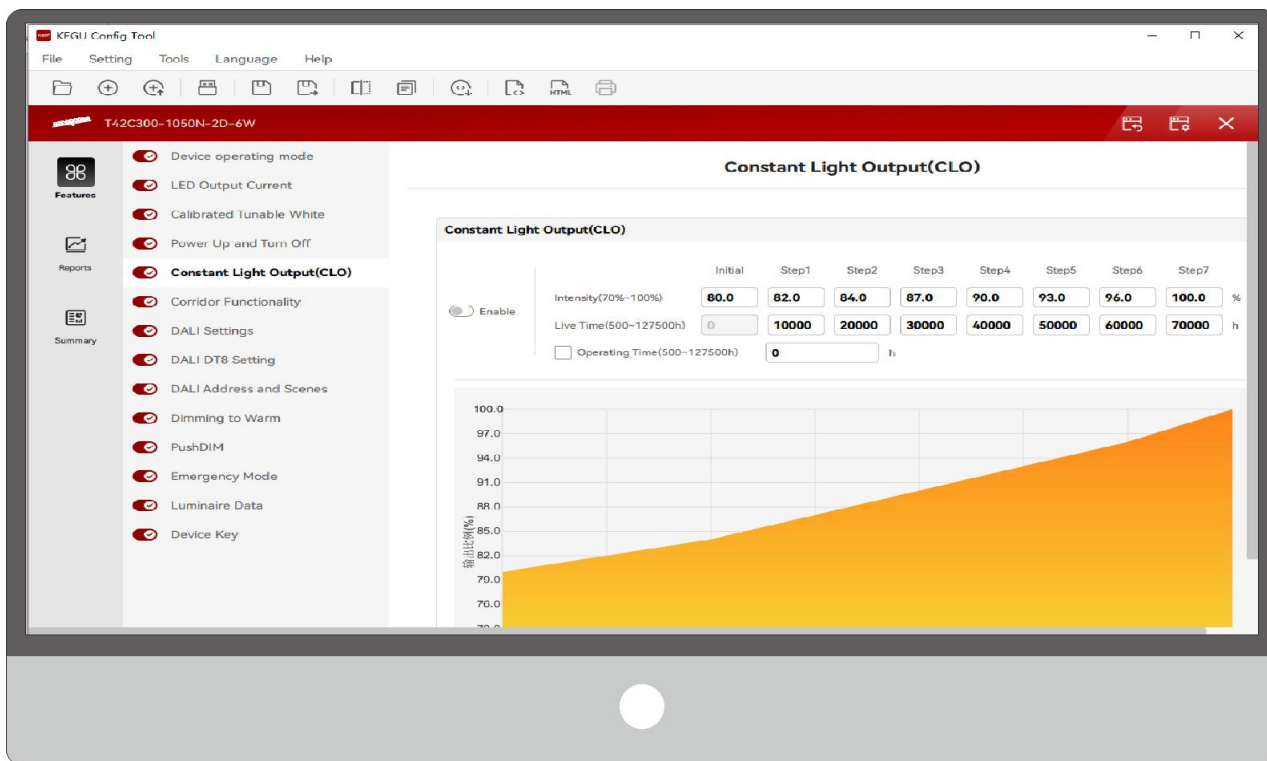

Corridor Functionality

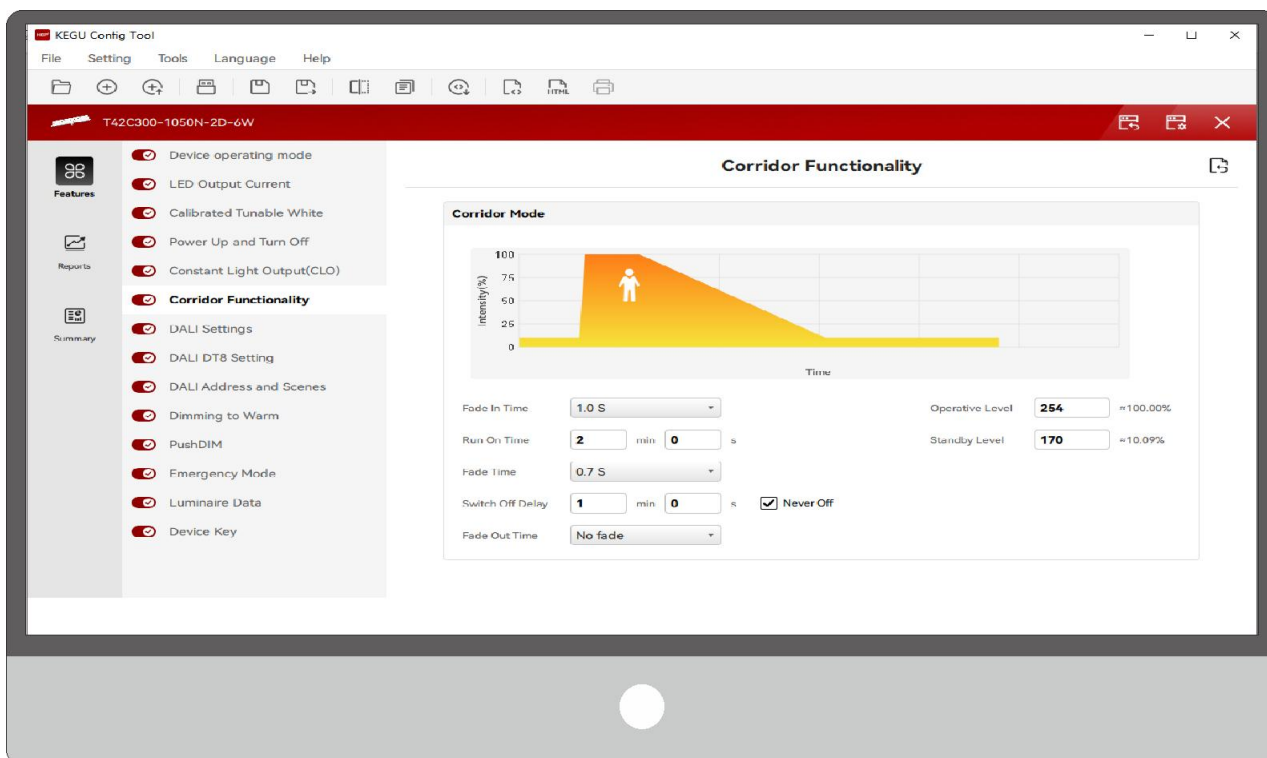

DALI Settings

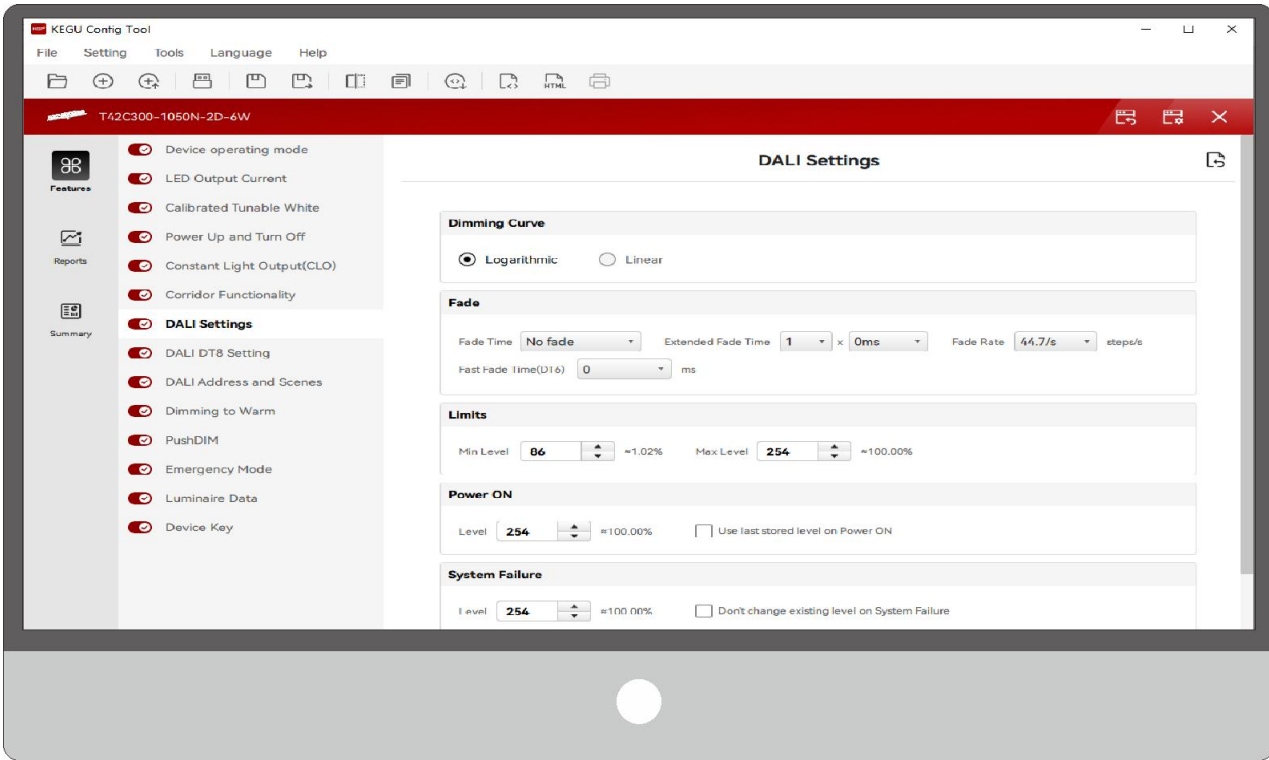

DALI DT8 Setting

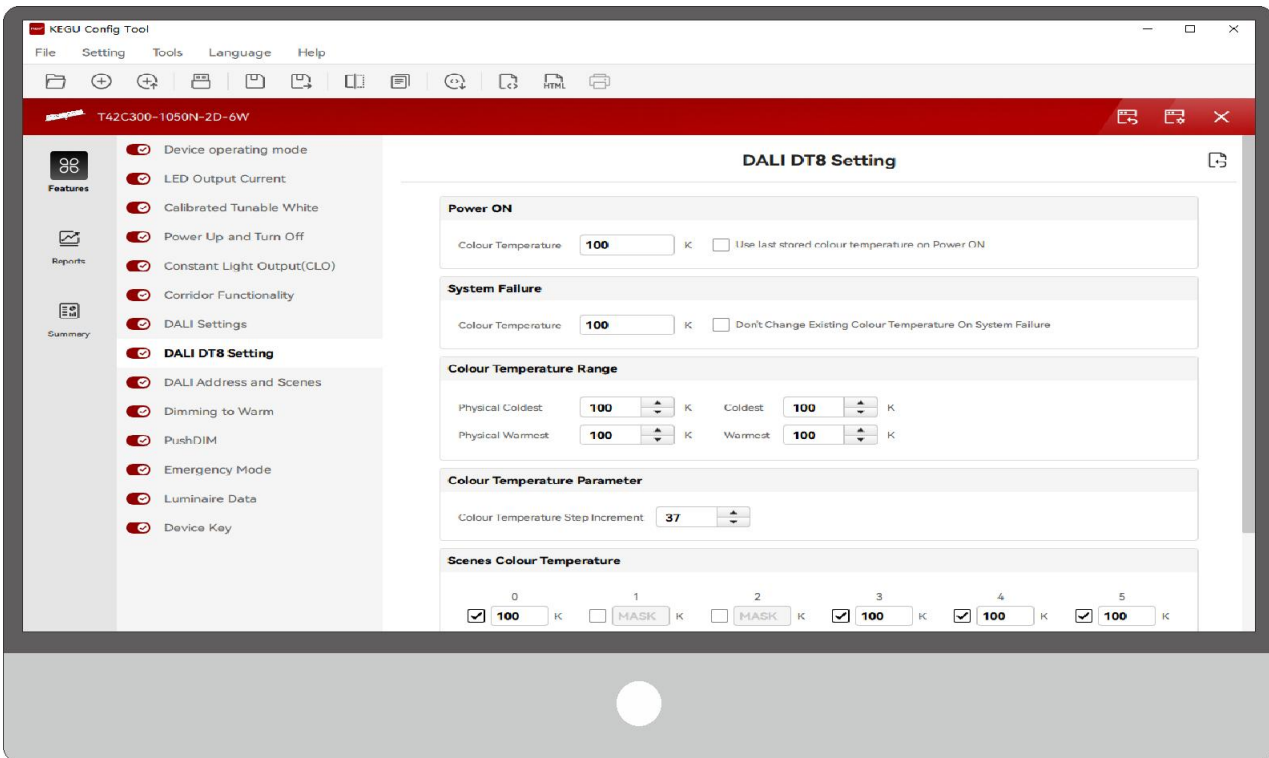

DALI Address and Scenes

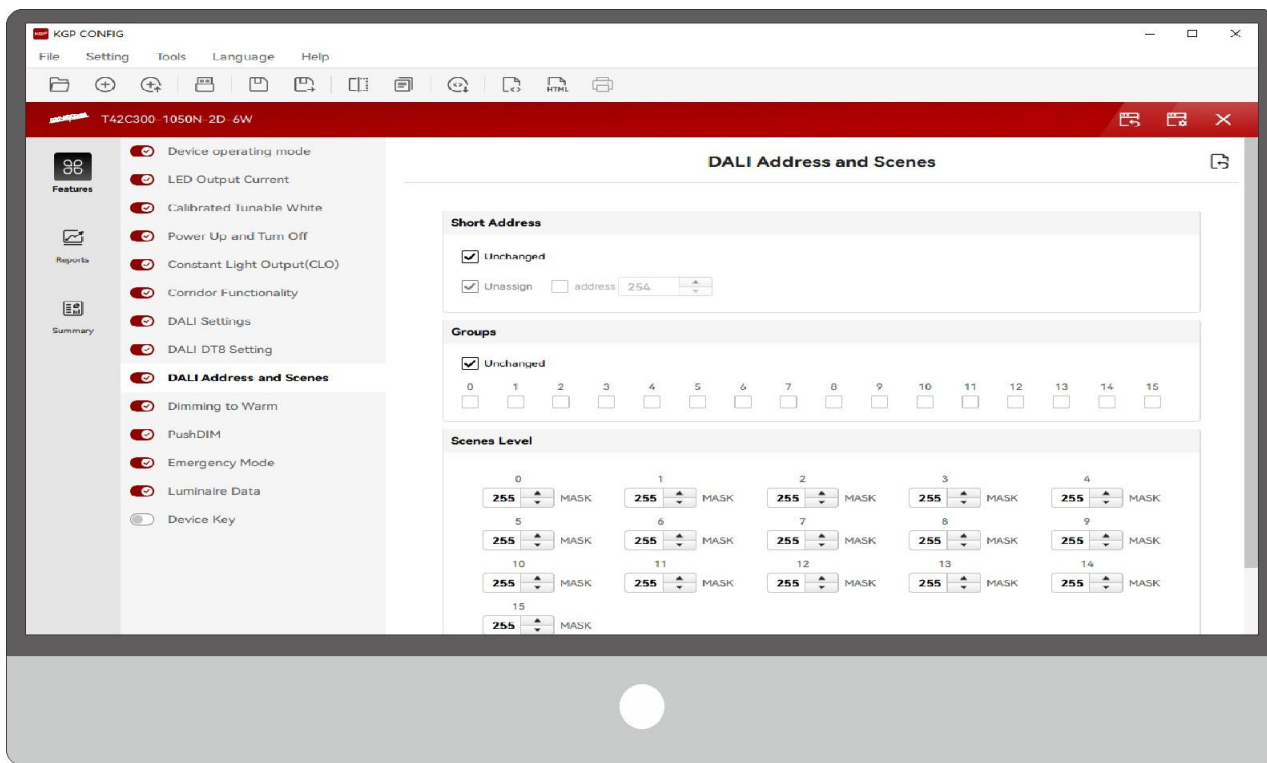

Dimming to Warm

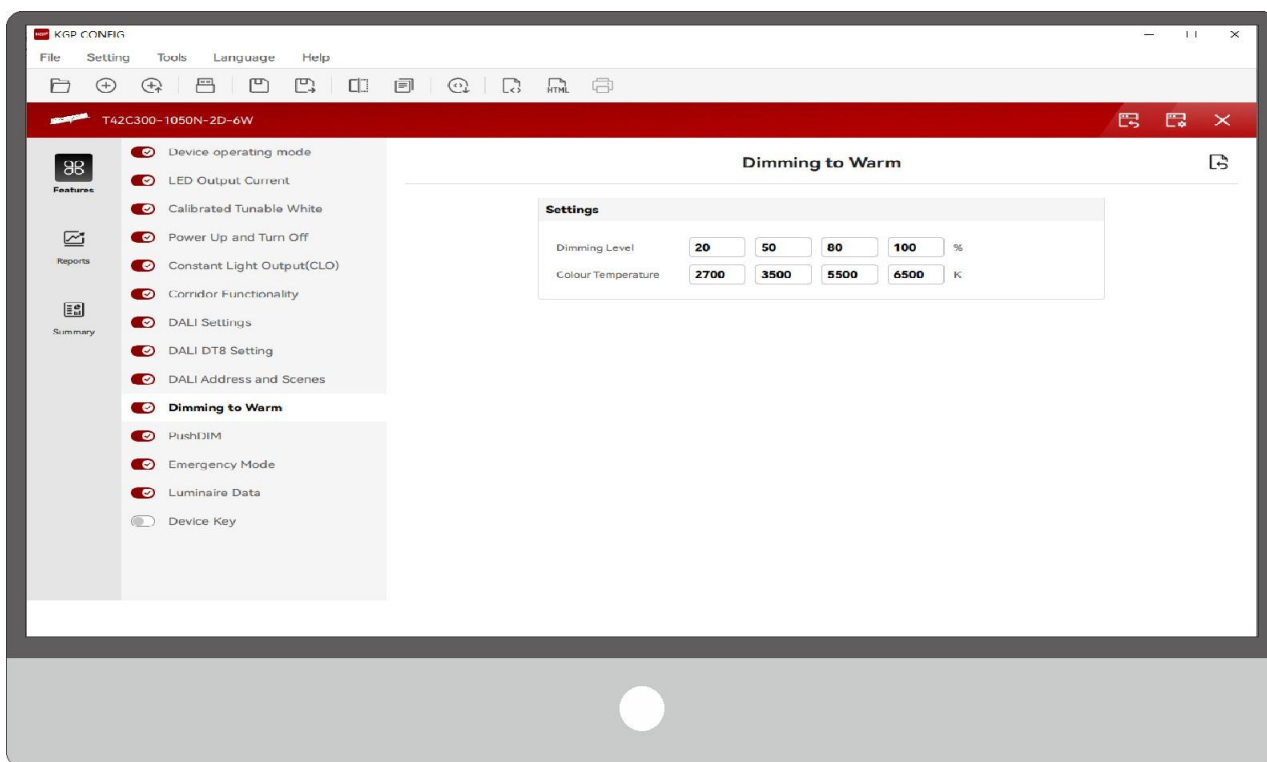

Push DIM setting

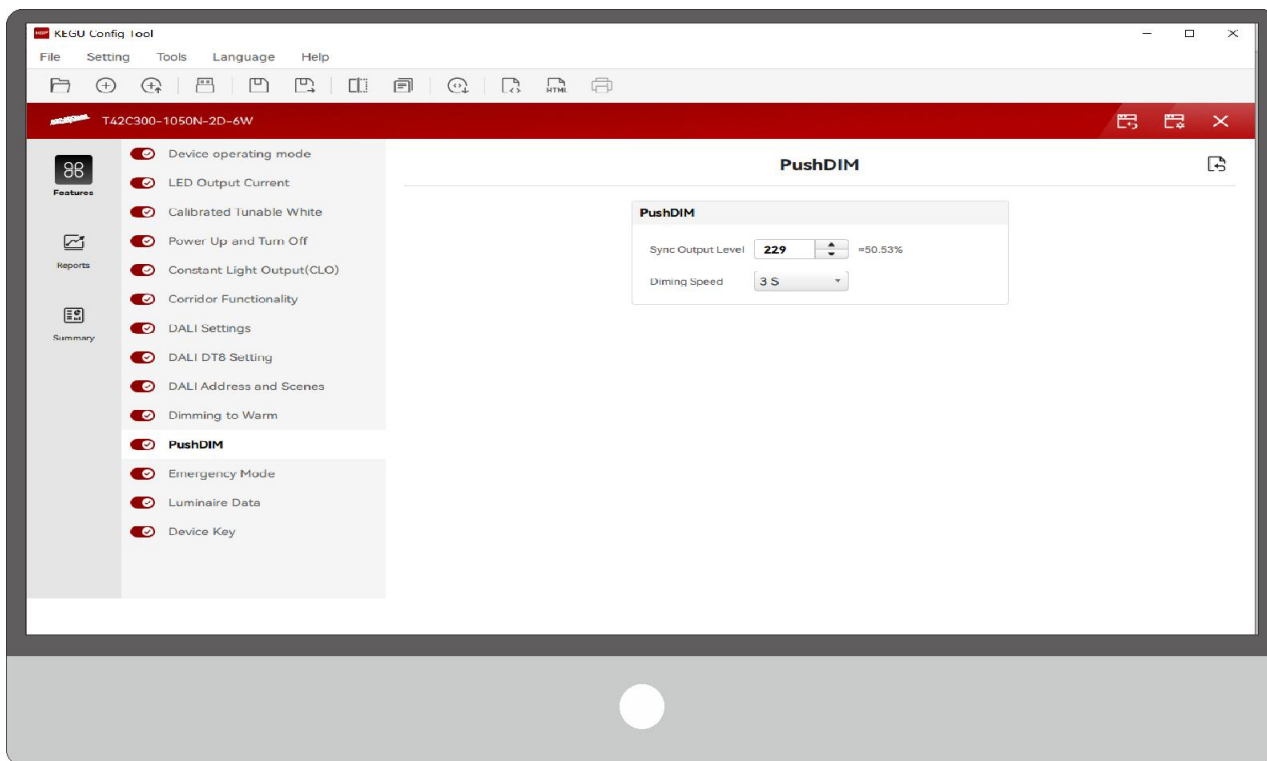

Emergency Mode setting

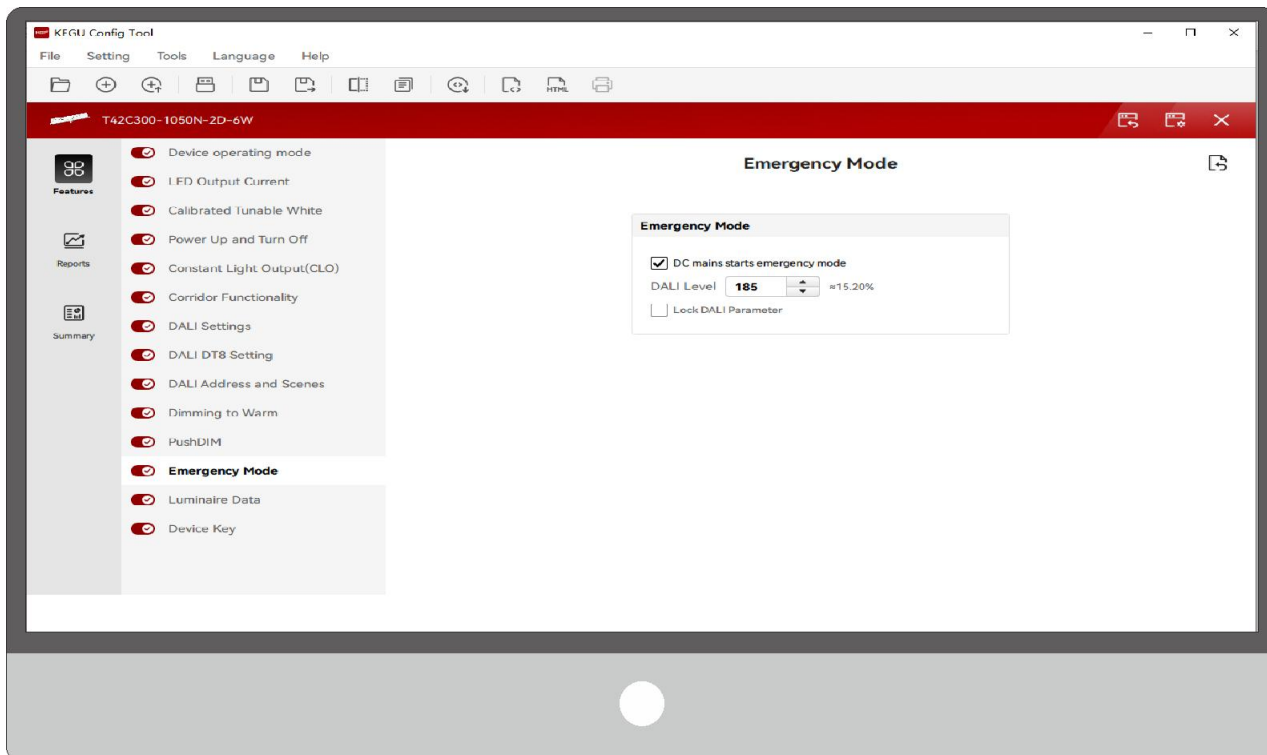

Luminaire Data

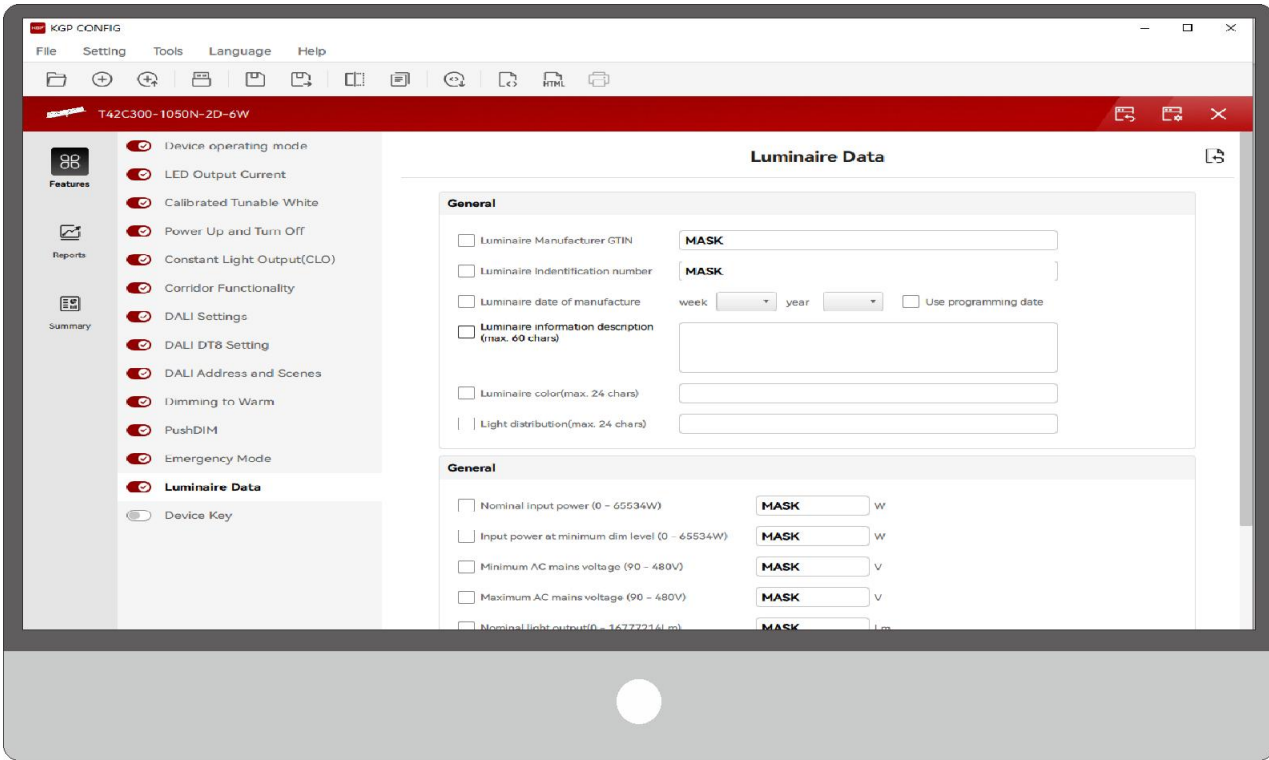

Device Key

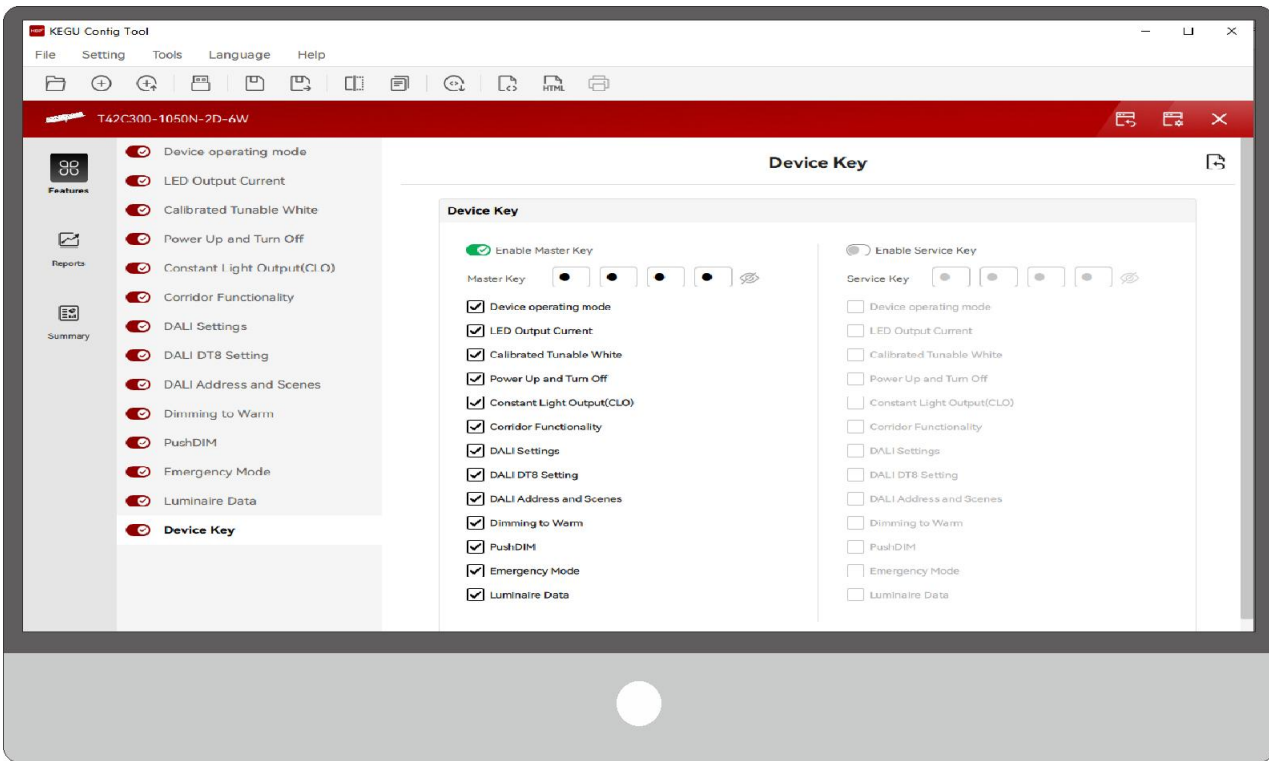

Step 4: the modification is complete, the download configuration page is displayed

Click this button to enter the “Download Configuration” window,select the “User” optionbox, and click the “Start Programming” button for the next step.

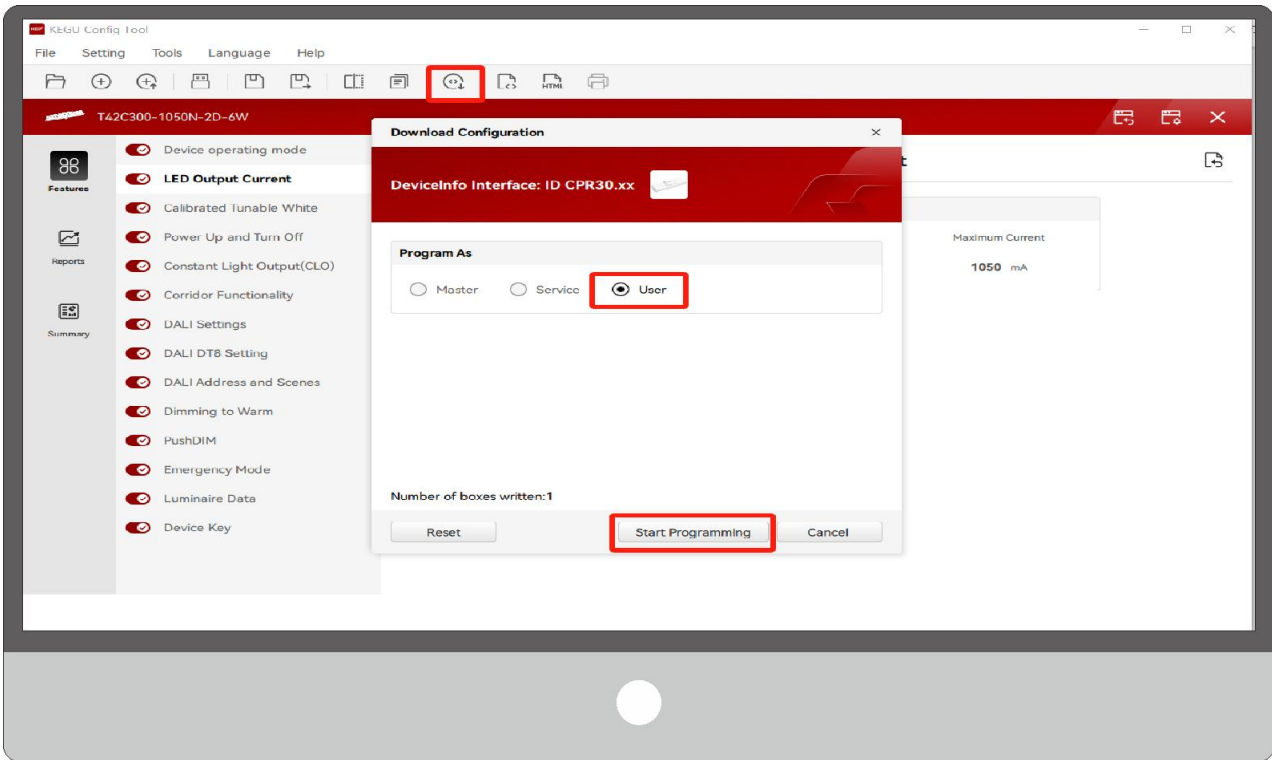

Click the “Start”button to program

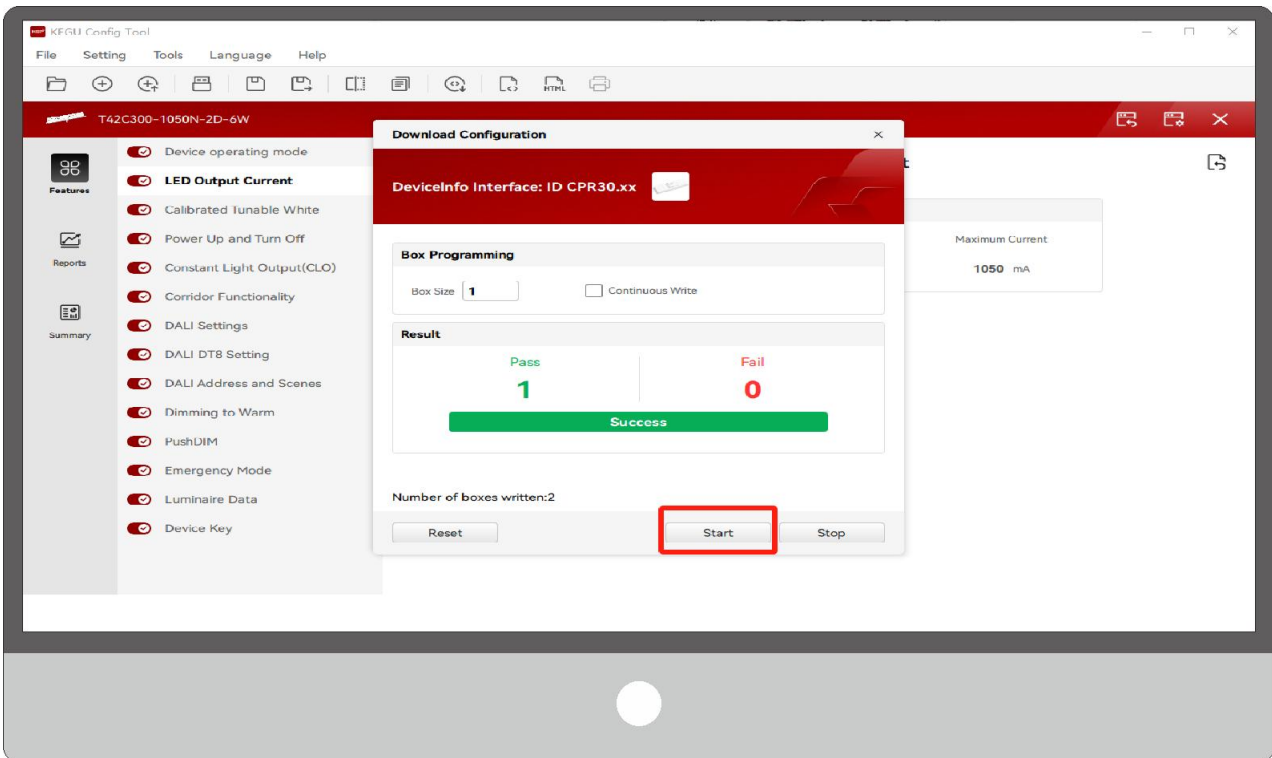

12 mobile client:

Note:

1. Please Make sure that you have enabled NFC function with your mobile phone/ tablet.
2. Please Make sure that the "NFC position" is matched.
3. Please do not power on the device before setting.

Step 1: Download the APP ,Then open the APP

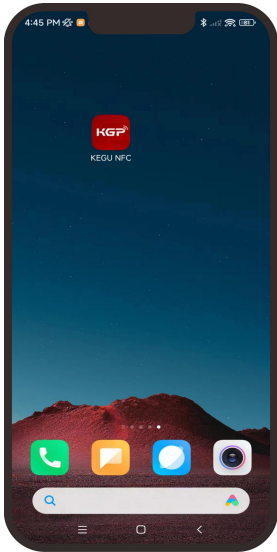

Step 2: Read product information

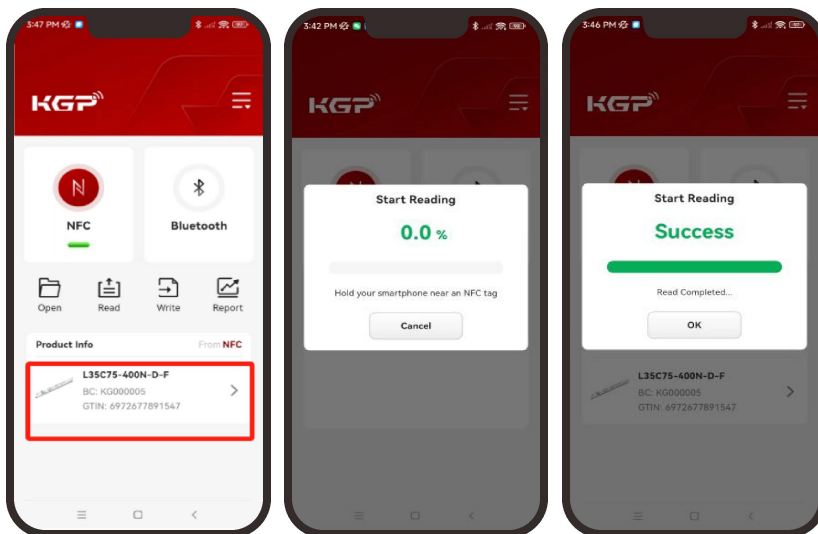

Step 3: You can choose to set the output current according to your needs, then write the configuration, and power on the device

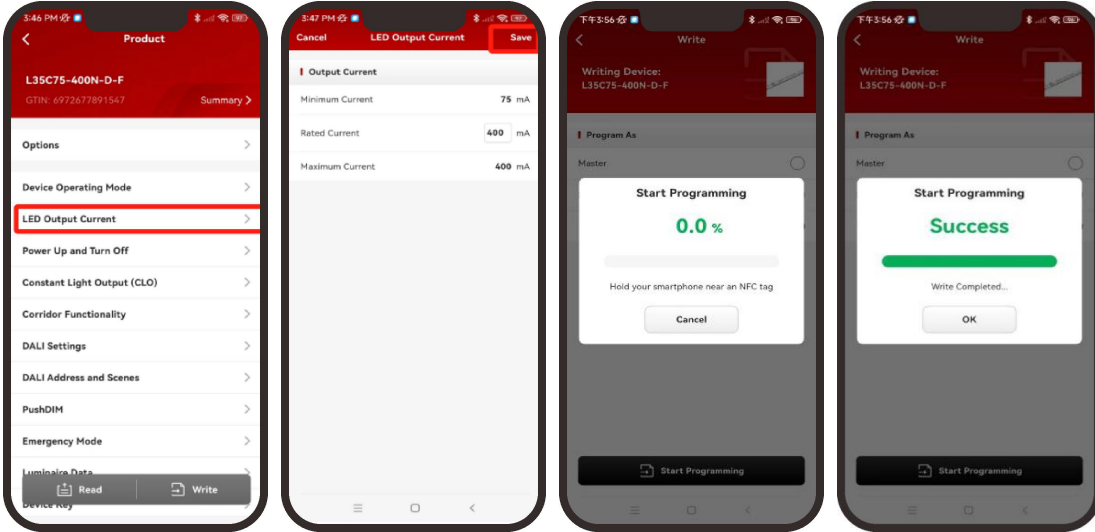

Device operating Mode:

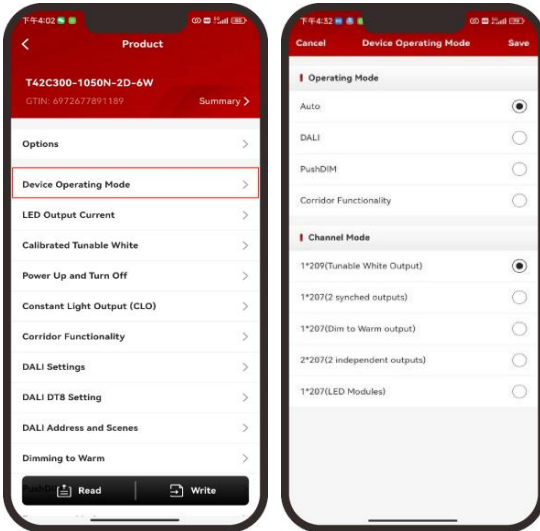

Output current:

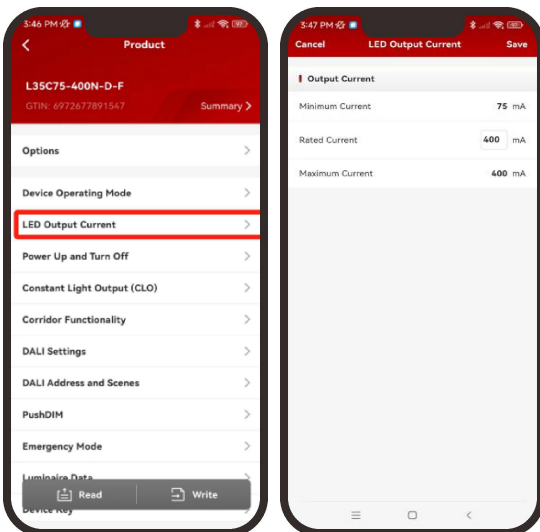

Calibrated Tunable White:

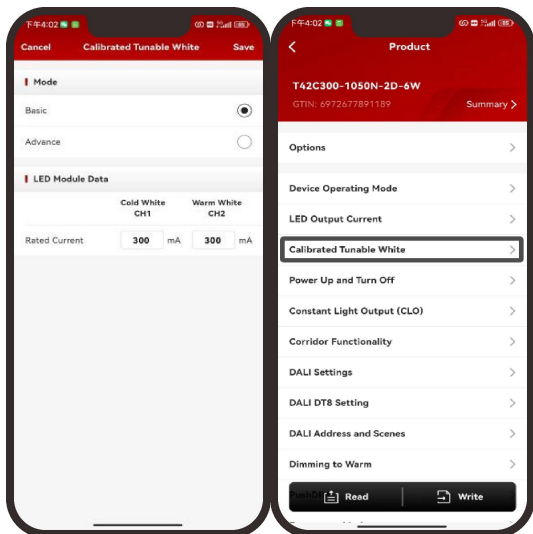

Power Up and Turn Off:

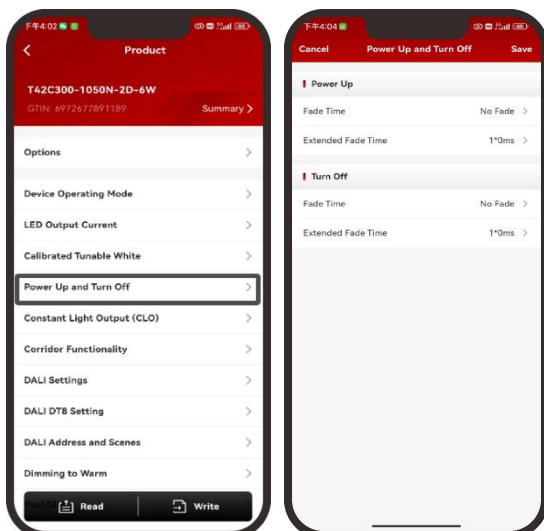

Constant Light Output (CLO):

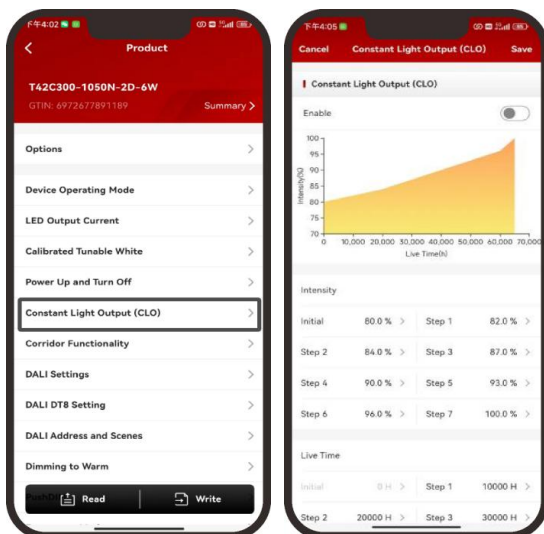

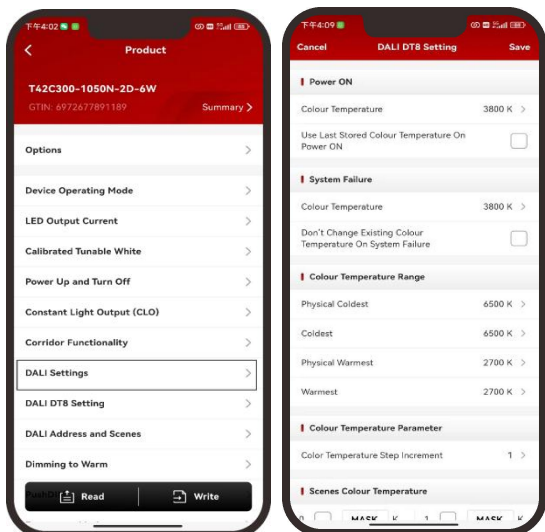

Corridor Functionality:

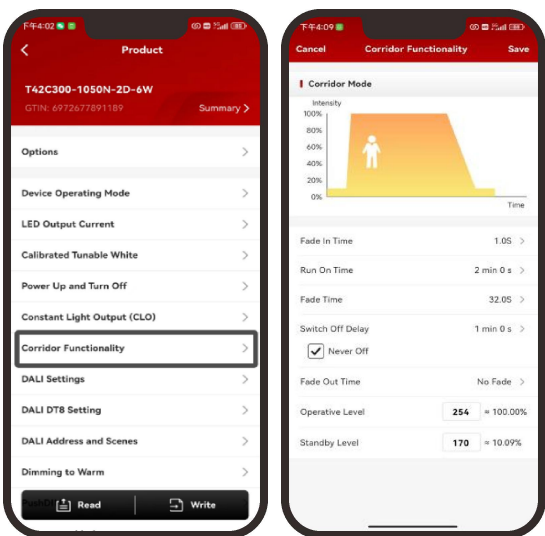

DALI Settings:

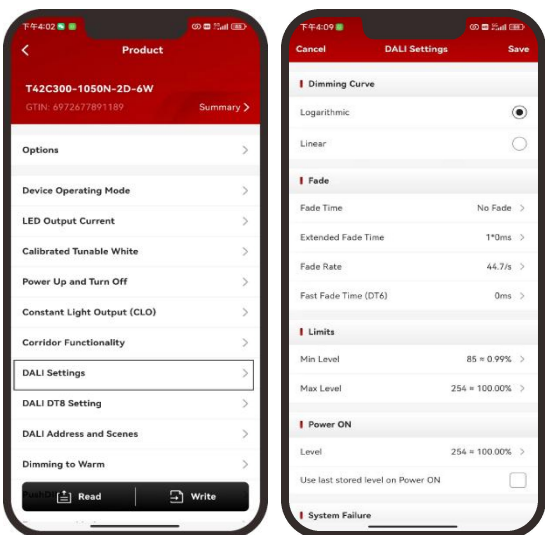

DALI DT8 Setting:

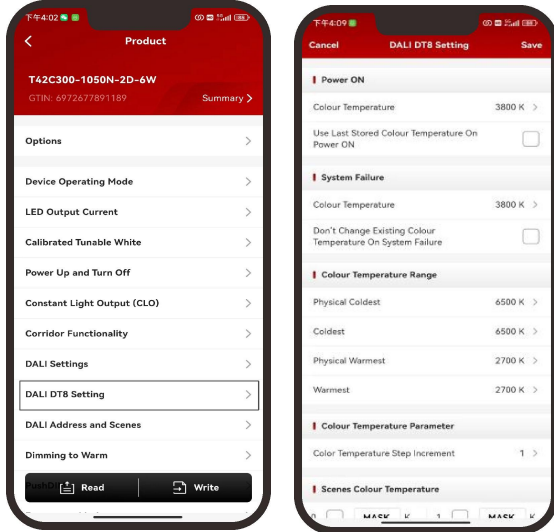

DALI Address and Scenes:

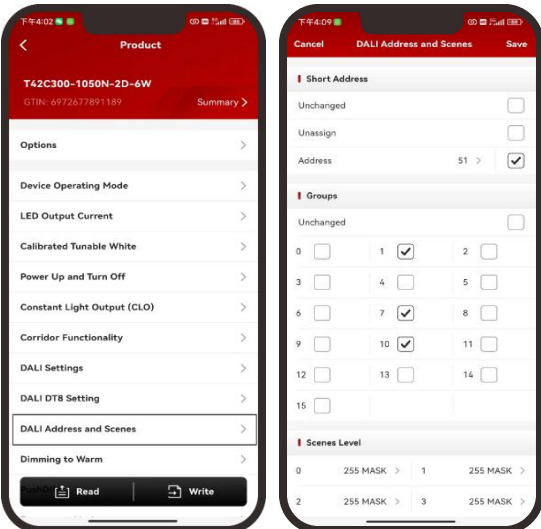

Dimming to Warm:

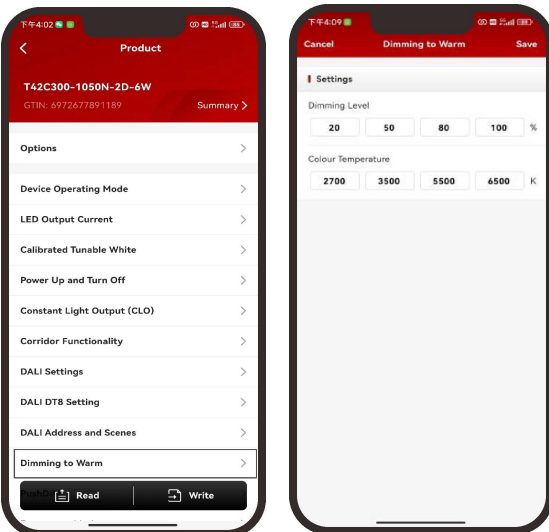

Push DIM:

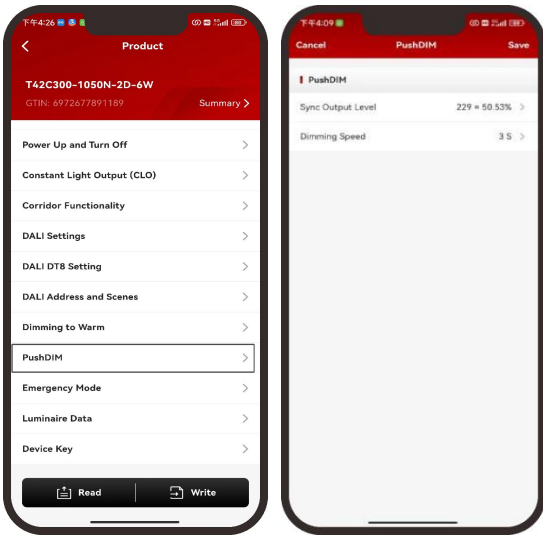

Emergency Mode:

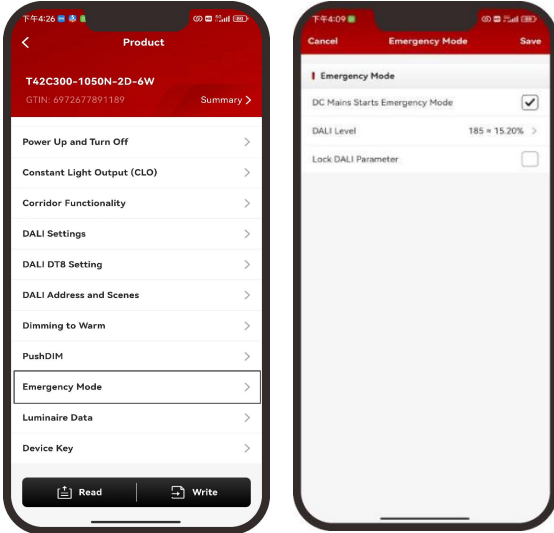

Luminaire Data:

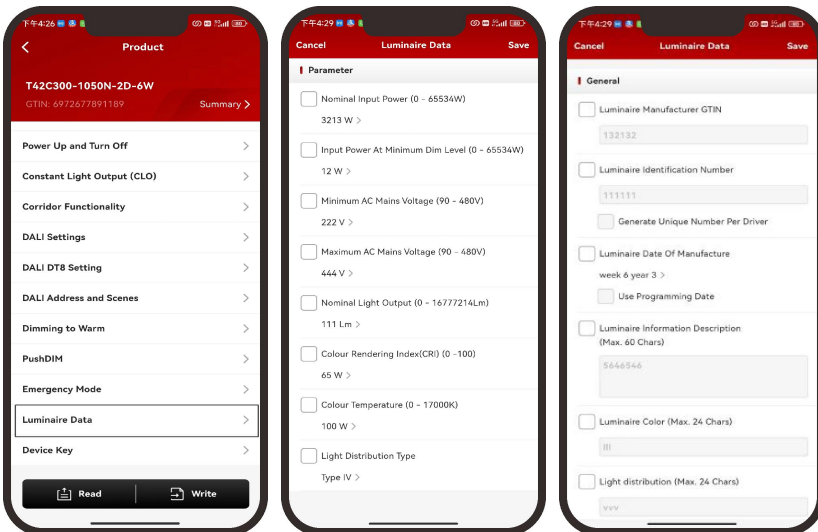

Device Key:

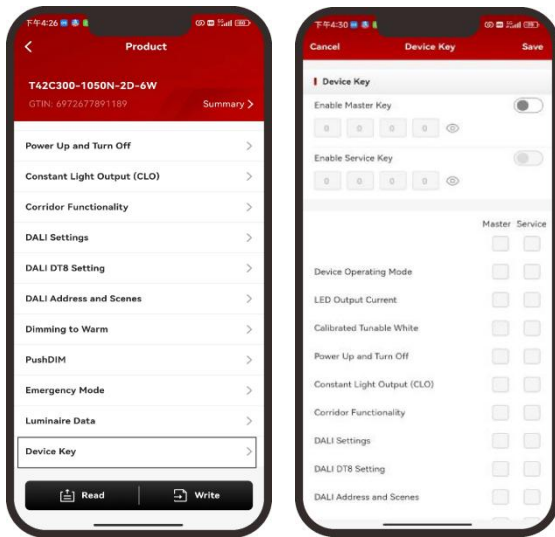

Tips:

- 1.NFC function doesn't require any power driver.
2. Many functions can be configured by NFC.Kindly check your desired functions.
3. All of our DALI drivers are in the best performance within our DALI master/ DALI IOT gateway.

13. Functions

13.1 OEM Identification

The OEM (Original Equipment Manufacturer) can set his own identification number.

DALI Part 251: Memory bank 1 extension.

13.2 OEM GTIN

The Original Equipment Manufacturer (OEM) can set his own Global Trade Item Number (GTIN).

DALI Part 251: Memory bank 1 extension.

13.3 Luminaire data

This function provides the asset management with accurate data about the luminaire.

DALI Part 251: Memory bank 1 extension.

DALI Part 253: Luminaire maintenance data.

13.4 LED current

The LED output current must be adapted to the connected LED module.

The value is limited by the current range of the respective device.

The output current of the LED driver can be adjusted in a certain range.

Adjustment is done by KGP Configurator via NFC.

13.5 Switch DIM

Integrated Switch DIM function allows a direct connection of a push button for dimming and switching.

Brief push (< 0.6 s) switches LED driver ON and OFF. The dim level is saved at power-down and restored at



power-up. When the push button is held, LED modules are dimmed. After repush the LED modules are dimmed in the opposite direction.

In installations with LED drivers with different dimming levels or opposite dimming directions (e.g. after a system extension), all LED drivers can be synchronized to 50 % dimming level by a 10 s push.

Use of push button with indicator lamp is not permitted.

More functions:

Action	Action duration	Function
Short push	<0.6s	Turn on/off
Short push five times	<3s	Quit Corridor mode
Long push	0.6-3s	Dimming up or down
Long push	10s	Sync all LEDs to be 50% brightness, and the dimming rate is changed to 3S
Long push	20s	Dimming rate is changed to 6S
Long push	>2mins	Enter Corridor mode - LED keep 100% brightness for 2mins.

13.6 Corridor FUNCTION

With the Corridor FUNCTION and a commercially available motion detector, it is easy to adapt the lighting in one area to its use.

That is, when the area is entered by a person, the lighting dims instantly to the desired brightness and is available in full strength.

After the area is left by the person, the brightness dims slowly to a smaller value or switches off completely.

The individual parameters of the desired profile, such as brightness values or delay times, can be adjusted flexibly and individually.

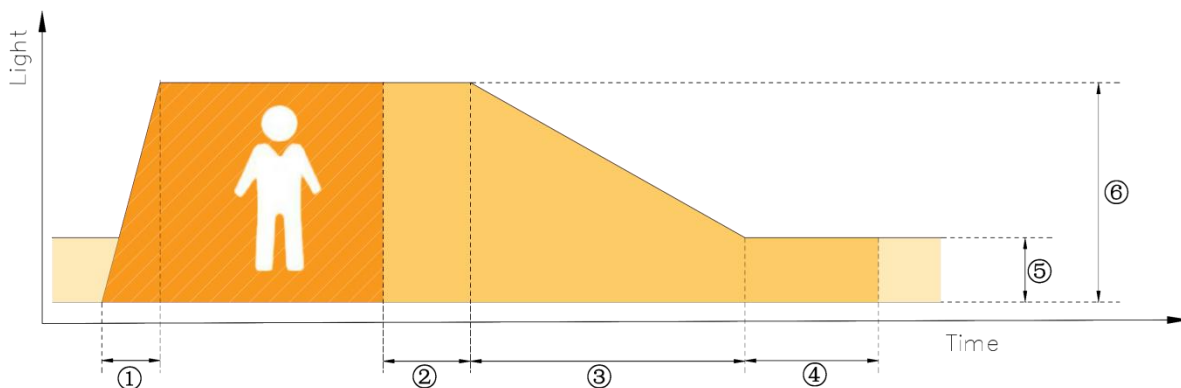

- ① Fade-in time(1s): the time that starts as soon as the presence of a person is detected. During the fade-in time the luminous intensity is faded up to the presence value.
- ② Run-on time(120s): the time that starts as soon as the presence of a person is no longer detected. If the presence of a person is detected again during the run-on time the run-on time is restarted from zero. If no presence is detected during the run-on time the fade time is started as soon as the run-on time expires.
- ③ Fade time(32s): the time during which the luminous intensity is faded from the presence value to the absence value.
- ④ Switch-off delay(Never Off): the time during which the absence value is held before the lighting is switched off. Depending on the profile selected the switch-off delay may have different values or may not be defined.
- ⑤ Absence value(default: 10 %): the luminous intensity when there is no person present.
- ⑥ Presence value (default: 100 %): the luminous intensity when persons are present.

13.7 Constant Light Output (CLO)

With this function the light output of the LED module can be kept equal over the lifetime.

The light output of an LED module reduces over the course of its lifetime.

The Constant Light Output (CLO) function compensates for this natural decline by constantly increasing the output current of the LED driver throughout its lifetime.

CLO shall be achieved by limitation of the LED current at the commissioning of the LED driver and providing a linear interpolation of the current over the time, depending on the data points given by the user.

The user has to insert up to eight pairs of data (time, level).

The output curve is the result of connecting the user data points linear.

Detailed description for CLO see product manual.

The minimal CLO starting point is limited by the smallest output current of the LED driver.

13.8 Dimming curve

DALI:The desired dimming behaviour is selected via two different dimming curves (logarithmic or linear).DALI:The desired dimming behaviour is selected via two different dimming curves (logarithmic or linear).

The default setting of the dimming behaviour is logarithmic.

14. REVISION HISTORY

DATE	VER	REMARK
2024.8.1	V1.0	Initial release.

