

Constant Current Dimmable Driver
恒流可调光驱动器

Model 型号: C30C200-900N-2D



Model 型号	Output Current 输出电流	Input Current 输入电流	Input Power 输入功率	Output Power Range 输出功率范围	PF 功率因数	Efficiency (*Typical) 效率 (典型值)	Output Voltage 输出电压	No load Voltage 空载电压
C30C200-900N-2D	200mA	0.07A	10.0W	1.80-8.40W	≥0.86	84%	9-42V	59V
	250mA	0.08A	12.4W	2.25-10.50W	≥0.87	85%	9-42V	59V
	300mA	0.09A	14.7W	2.70-12.60W	≥0.88	86%	9-42V	59V
	350mA	0.11A	16.9W	3.15-14.70W	≥0.89	87%	9-42V	59V
	400mA	0.12A	19.1W	3.60-16.80W	≥0.90	88%	9-42V	59V
	450mA	0.13A	21.5W	4.05-18.90W	≥0.91	88%	9-42V	59V
	500mA	0.14A	23.9W	4.50-21.00W	≥0.92	88%	9-42V	59V
	550mA	0.15A	26.0W	4.95-23.10W	≥0.93	89%	9-42V	59V
	600mA	0.16A	28.3W	5.40-25.20W	≥0.94	89%	9-42V	59V
	650mA	0.18A	30.7W	5.85-27.30W	≥0.94	89%	9-42V	59V
	700mA	0.19A	33.0W	6.30-29.40W	≥0.95	89%	9-42V	59V
	750mA	0.18A	32.0W	6.75-28.50W	≥0.95	89%	9-38V	59V
	800mA	0.19A	34.2W	7.20-30.40W	≥0.96	89%	9-38V	59V
	850mA	0.19A	33.4W	7.65-29.75W	≥0.96	89%	9-35V	59V
	900mA	0.19A	34.4W	8.10-30.60W	≥0.97	89%	9-34V	59V

* Test result @230V, 50Hz, Full Load. Current setting @ 1mA-steps (NFC)
230V, 50Hz, 满载。当前设置@1mA 步数 (NFC)

1. Parameters 参数表

Category 类别	Item 项目	Technical Norm 技术指标
Features 特性	Output Type 输出类型	Constant Current 恒流
	Dimming Type 调光类型	DALI-2
	Output Features 输出特性	Isolation 隔离
	IP Grade IP 等级	IP20
	Insulation Class 绝缘等级	Class II II类
Input 输入参数	Rated Input Voltage 额定输入电压	220-240VAC
	Range of Input Voltage 输入电压范围	198-264VAC or 180-280VDC



	Frequency 频率	0/50/60Hz
	Input Current 输入电流	≤0.19A (230VAC, full load)满载
	Input Power 输入功率	≤34.4W (230VAC, full load)满载
	Power Factor 功率因素	≥0.97 (230VAC, full load)满载
	THD 谐波	≤10% (230VAC, full load)满载
	No-load Power Consumption 空载功耗	≤0.5W @230VAC
	Inrush Current 浪涌电流	≤60A/16us (230VAC, full load)
Output 输出参数	Output Voltage Range 输出电压范围	9-42VDC@200-700mA
		9-38VDC@750-800mA
		9-35VDC@850mA
		9-34VDC@900mA
	No Load Voltage 空载电压	59VDC Max.
	Output Current 输出电流	200mA -900mA (Max. output)
	Max. Output Power 最大输出功率	30W
	Efficiency 效率	≥89% (230VAC, full load)
	Current Ripple 纹波电流(< 120 Hz)	±5% (Imax-Imin)/(Imax+Imin)
	PstLM 频闪	≤1
	SVM 频闪效应	≤0.4
	Current Accuracy 电流精度	±5%
	Line Regulation 线性调整率	±5%
	Load Regulation 负载调整率	±5%
Started Delay Time 启动延时	≤1S(230VAC, full load)	
Control Method 控制方式	Secondary PUSH dimming PUSH 调光功能	Secondary PUSH dimming (Max. lead wire length : 20m,same port of DALI) PUSH 调光 (最大导线长度:20 米, 与 DALI 相同的端口)
	PUSH dimming terminal PUSH 调光终端	Max parallel connections qty for Push-dim 15 PCS 最大连接数量为 15 PCS
	DALI function DALI 功能	DALI dimming (Max. lead wire length: 300m) Logarithmic or linear dimming curves are available DALI-2 certified incl. Parts 251, 252, 253,CLO DALI 调光 (最大导线长度:300 米) 可提供对数或线性调光曲线 DALI-2 认证, 包括第 251、252、253、CLO 部分
	Dimming range 调光范围	DALI dimming: 1%-100%,Dim to off . DALI 调光:1%-100%, 调至关闭。
	Color temperature range 色温范围	2000K-7000K
	Current Interface 通信接口	Near field communication (NFC) 近场通信 (NFC)
	Adjustable output current 可调输出电流	1mA-steps (NFC) 1mA 步 (NFC)
Protection	Short Circuit Protection 短路保护	Auto Recovery 自动恢复



保护特性	Overload Protection 过载保护	Auto Recovery 自动恢复
	No-load Protection 空载保护	Auto Recovery 自动恢复
	Insulation voltage 绝缘电压	3000V 5mA 60S between P-S
	Insulation resistance 绝缘电阻	>100M ohm @ 500VDC
	Leakage current 泄漏电流	I/P to O/P <0.7mA
Environment 使用环境	Ta/Operation Temperature 工作温度	-20....+45°C
	Ts/Storage Temperature 储存温度	-25....+85°C
	Tc/Enclosure Temperature 外壳温度	85°C
	Humidity 湿度	10%....90%RH
	Atmosphere 大气压强	86-108KPa
Construction 安装	Connection Method 连接方式	Push-in Terminal 推入式端子
	Installation 安装方式	Independent 独立式
	PRI Wire preparation 输入线径	0.5-1.5 ^{mm} / 8-9mm
	SEC Wire preparation 输出线径	0.5-1.5 ^{mm} / 8-9mm
	DALI Wire preparation DALI 信号线径	0.5-1.5 ^{mm} /8-9mm
	Dimension 尺寸	Built in 内置 :122.5*44*23mm (L*W*H) Independent-Small side cover 独立 - 小侧盖 :162.3*44*23mm (L*W*H) Independent-Large side cover 独立 - 大侧盖 :216.5*44*23mm (L*W*H)
Standards 标准	Certification 证书	CE
	Safety Standards 安全标准	EN 61347-1:2015/A1:2021 EN 61347-2-13:2014/A1:2017 EN IEC 62384:2020 EN 62493:2015/A1:2022
	EMC Standards 电磁兼容标准	EN IEC 55015:2019 EN IEC 55015:2019/A11:2020 EN IEC 61000-3-2:2019/A1:2021 EN 61000-3-3:2013/A2:2021 EN 61547:2023
	RED	EN 300 330 V2.1.1:2017 EN 301 489-1 V2.2.3:2019 EN 301 489-3 V2.3.2:2023 EN 62479:2010 EN 50663:2017
	Performance 性能标准	EN62384:2020
	Surge 浪涌	L-N/2KV
	Others 其他	RoHS 环保
REACH 化学	EU Regulation (EC) No 1907/2006	
Life Time 寿命	50000h @Ta	
Warranty 质保	5years ,F.R. < 10000ppm (质保期过的失效率)	
Noise 噪音	≤ 24dB @Background noise ≤18dB ,Interval≥15cm ≤24 dB@背景噪声≤18dB, 间隔≥15 厘米	



Remark 备注:

- All Parameters, if not specified, are measured at 230VAC/50Hz and 25°C ambient temperature.
所有参数（如未指定）均在 230VAC/50Hz 和 25°C 环境温度下测量。
- LED Driver is a component of the luminaires, Luminaires and wire layout will affect the EMC, please check the EMC with end products again.
LED 电源作为整灯中的一个零部件与终端设备结合使用，因 EMC 性能受 LED 灯具以及走线的影响，终端设备制造商需对整套装置重新进行 EMC 确认。
- During the PUSH DIM test, the number of parallel connections must be less than 15PCS
在 PUSH DIM 测试期间，并行连接的数量必须小于 15PCS
- Do not install upside down.
禁止倒立安装。

2. Connected quantities of different current Breaker 不同电流断路器的连接数量

TYPE 类型	Connected quantities of different current Breaker 不同电流断路器连接数量						Input Voltage (V) 输入电压	Inrush Current(A) 浪涌电流	Time (µs) 时间
	current (A)	10	13	16	20	25			
	Installation wire diameter 安装线直径	1.5mm ²	2.5mm ²	2.5mm ²	4mm ²	4mm ²			
TYPE B	9	12	15	18	23	@230VAC	65	200	
TYPE C	15	19	24	30	37				
TYPE D	24	31	38	47	59				

3. Label 铭牌





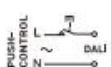

C30C200-900N-2D
Constant Current LED Dimmable Driver
PRI:220-240VAC 50/60Hz 0.19A Max.
SEC:200-900mA 9-42VDC NoLoad:59VDC Max.30W
ta:-20...45°C tc:85°C For LED modules Only

PRI: ● L
● N

DIM: ● DA
● DA



SEC ● +
● -

CW ● +
● -

wire preparation
8-9mm

PRI:0.5-1.5
DALI:0.5-1.5
SEC:0.5-1.5



4. Dimming curve 调光曲线

formula for DALI dimming.

DALI 调光公式。

$$X(n) = 10^{\left\{ \frac{(n-1)}{(253/3)} - 1 \right\}}$$

Here, n means the target dimming stage of the total 254 stages.

n 指总共 254 个调光级中的目标调光级。

X(n) means the percent of the maximum output current

X (n) 表示最大输出电流的百分比

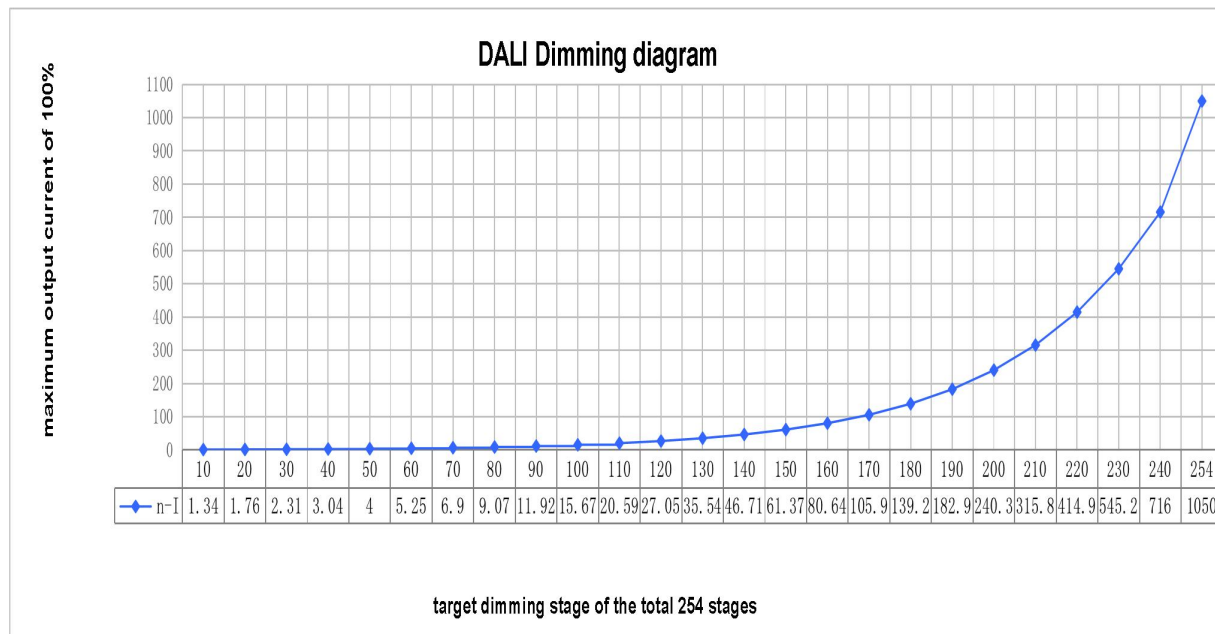

5. Electrical values 电参数图表

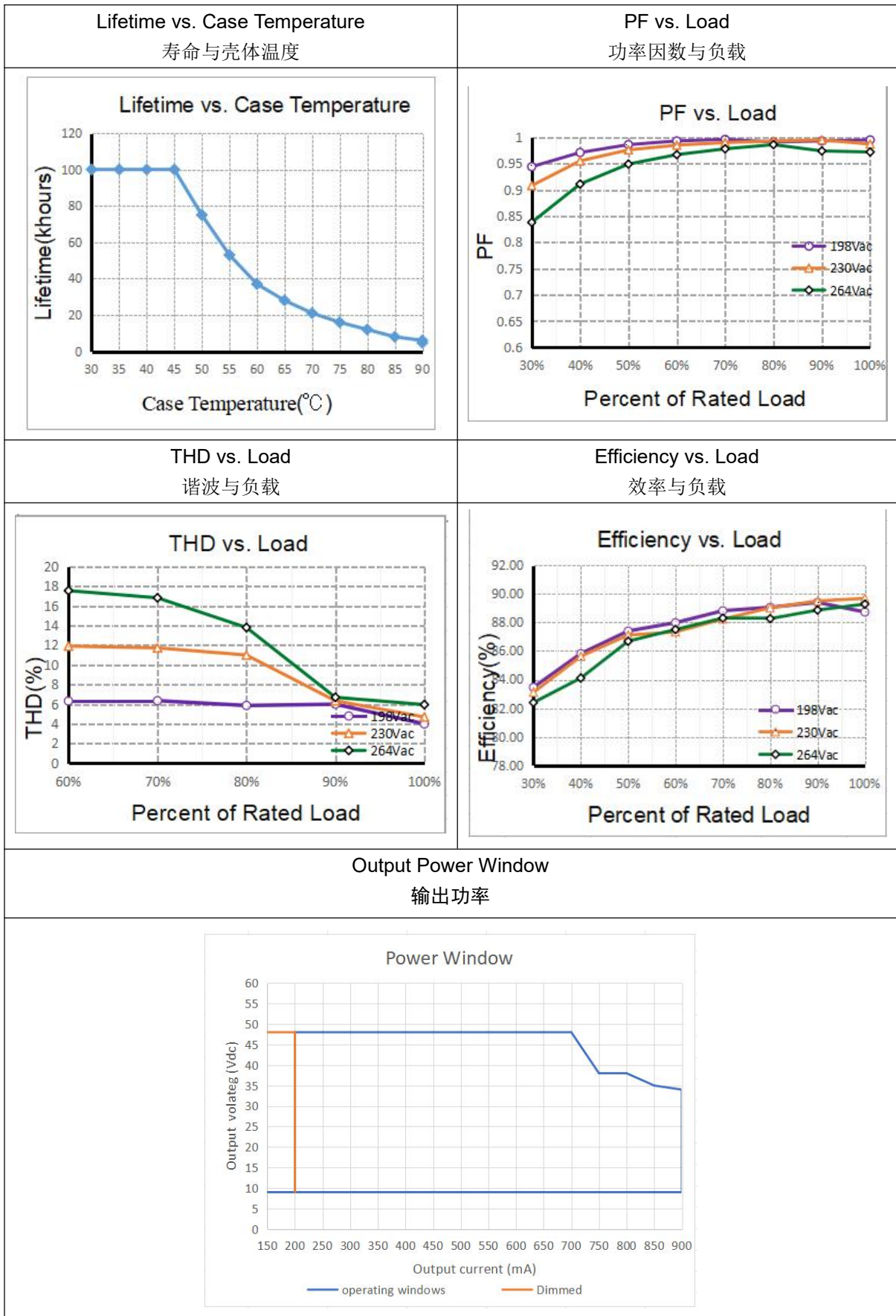

6. Dimension 尺寸 (Unit: mm)
SC (A) :

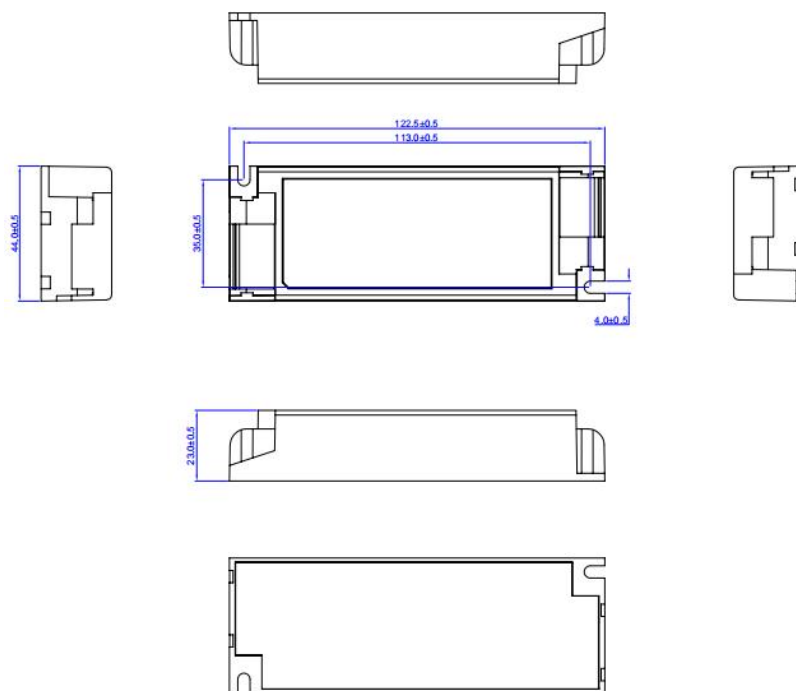

Small side cover(B):

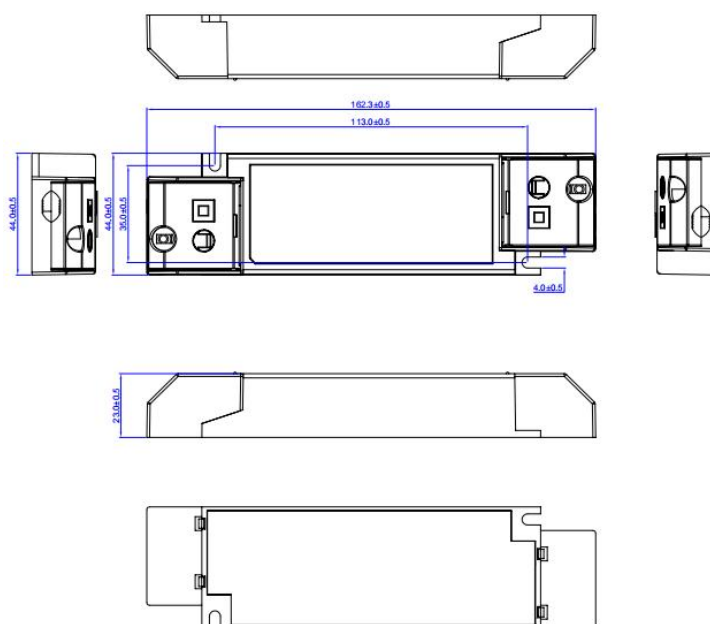

Large side cover(C):

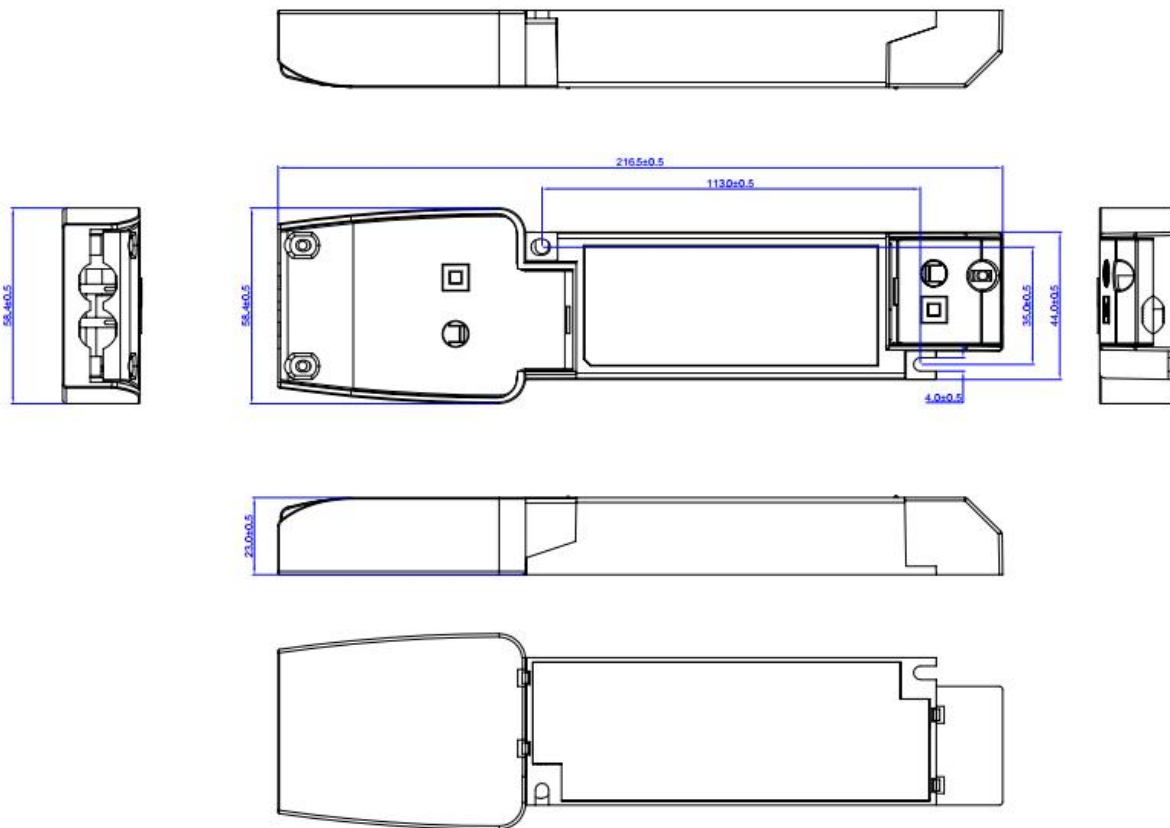

7. Wiring Diagram 接线图

Fig. A: DALI Dimming

图A: DALI 功能接线图

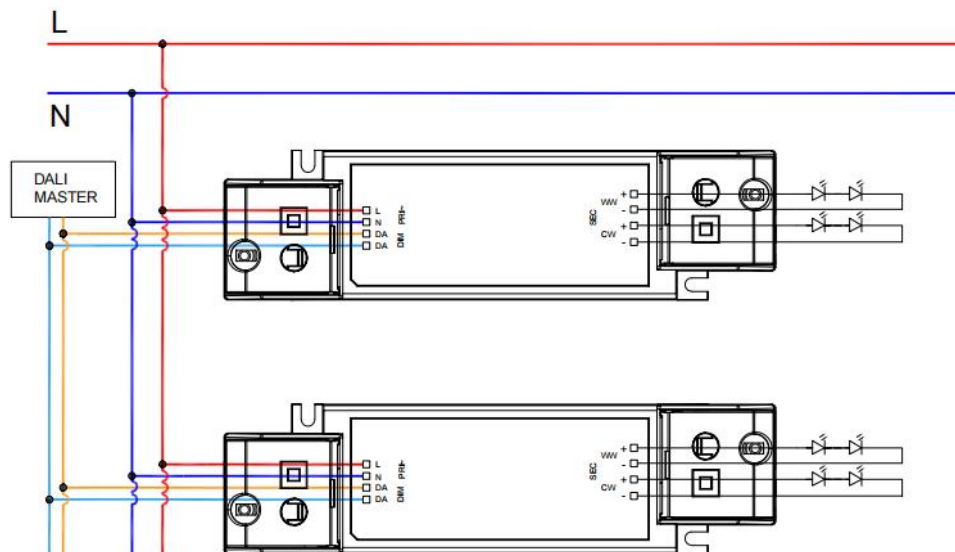

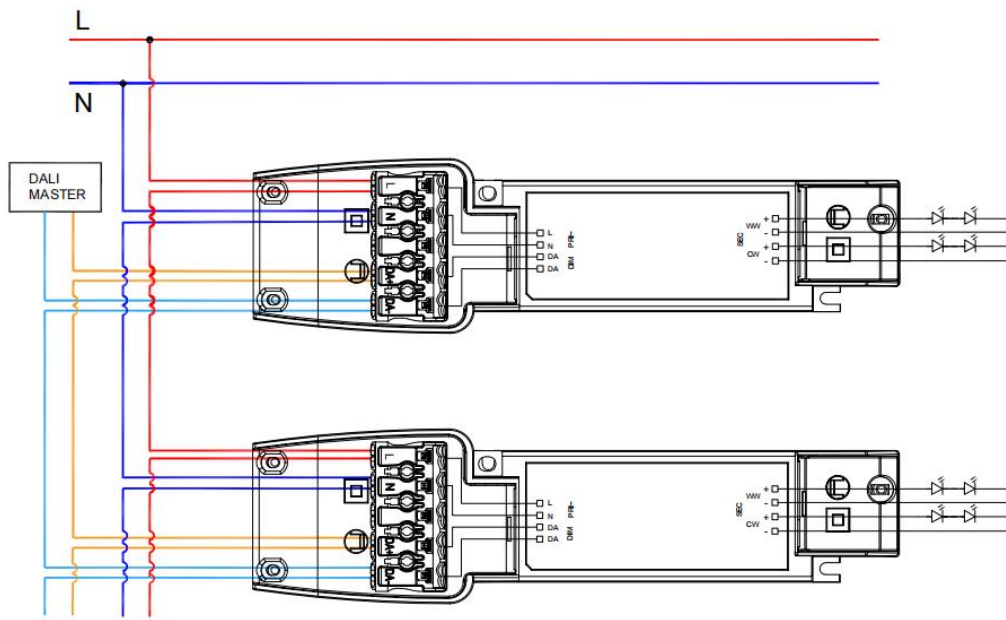
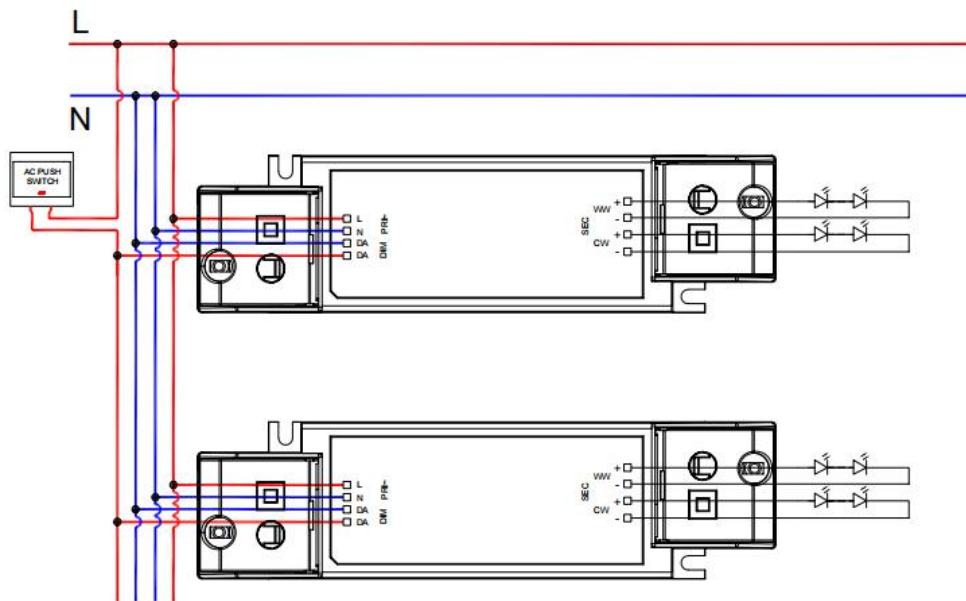
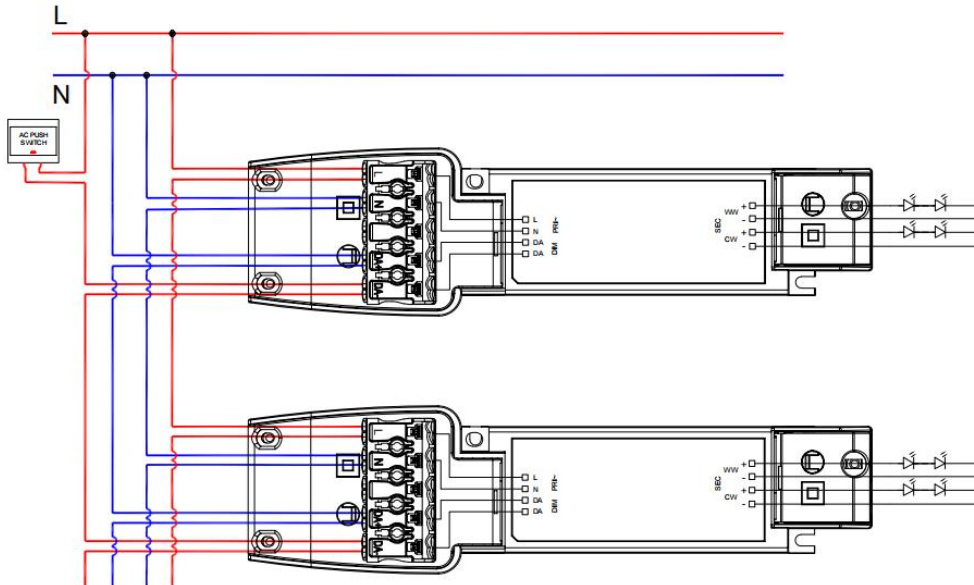

Fig. A: Push Dimming
图A: Push 功能接线图





1. The factory default brightness is at 100%.
出厂时的默认亮度为 100%。
2. Up to 15 drivers can perform the PUSH dimming at the same time when utilizing one common push button
当使用一个通用的按键时，多达 15 个驱动程序可同时执行 PUSH 调光
3. The maximum length of the cable from the push button to the last driver is 200 meters
从按钮到最后一个电源的电缆的最大长度为 200 米

8. Packing information 包装信息

SC(A)

Packing way 包装方式	Model 型号	Colour 颜色	Carton L*W*H(mm) 箱尺寸	Pcs/ Carton 箱/个	Net weight/ Pcs(kg) 净重/ 千克	Net weight/ Carton(kg) 净重/箱 (千克)	Gross weight/ Carton(kg) 总重/箱 (千克)
Industrial 工业	C30C200-900N-2D	White 白色	270*255*190	60	0.128	7.68	8.18

Small side cover(B)

Packing way 包装方式	Model 型号	Colour 颜色	Carton L*W*H(mm) 箱尺寸	Pcs/ Carton 箱/个	Net weight/ Pcs(kg) 净重/ 千克	Net weight/ Carton(kg) 净重/箱 (千克)	Gross weight/ Carton(kg) 总重/箱 (千克)
Industrial 工业	C30C200-900N-2D	White 白色	375*270*180	60	0.146	8.76	9.26



Large side cover(C)

Packing way 包装方式	Model 型号	Colour 颜色	Carton L*W*H(mm) 箱尺寸	Pcs/ Carton 箱/个	Net weight/ Pcs(kg) 净重/ 千克	Net weight/ Carton(kg) 净重/箱 (千克)	Gross weight/ Carton(kg) 总重/箱 (千克)
Industrial 工业	C30C200-900N-2D	White 白色	457*250*220	60	0.1925	11.55	11.55

9. Wiring instructions 接线说明

- All connections must be kept as short as possible to ensure good EMI behaviour
所有的连接线尽可能的短，以保证良好的 EMI
- Mains leads should be kept apart from LED Driver and other leads (ideally 5 – 10 cm distance)
电源线应和驱动器以及其他连接线保持一定的距离（建议 5-10cm）
- Advice the maximum length of output wires is 0.5 m
建议输出线的最大长度不超过 0.5m
- Secondary switching is not permitted (Except for constant voltage)
不允许二次侧开关（恒压除外）
- Incorrect wiring can damage LED modules.
错误的布线会损坏 LED 模组
- The wiring must be protected against short circuits to earth (sharp edged metals parts, metal cable clips, louver, etc.)
防止线路电线对地短路。（尖锐的金属零件、金属电缆夹、百叶窗等）
- Hot plug-in is not supported due to residual output voltage of > 0 V up to mains voltage. Danger to life.
不支持热插拔，因为剩余输出电压大于 0 v，最高可达电源电压。危及生命。
- When connecting an LED load, restart the device to activate the LED output.
连接 LED 负载时，请重新启动设备以激活 LED 输出。
- This can be done via mains reset or via interface (DALI, DSI, switch DIM).
这可以通过主电源复位或通过接口（DALI、DSI、开关 DIM）来完成。

10. Replace LED module 更换 LED 模块

- Mains off 电源关闭
- Remove LED module 拆下 LED 模块
- Wait for 30 seconds 等待 30 秒
- Connect LED module again 再次连接 LED 模块
- Hot plug-in or secondary switching of LEDs is not permitted and may cause a very high current to the LEDs
不允许对 LED 进行热插拔或二次开关，可能导致 LED 电流过高

11. Functions 功能

11.1 OEM Identification



OEM 标识

The OEM (Original Equipment Manufacturer) can set his own identification number.

DALI Part 251: Memory bank 1 extension.

11.2 OEM GTIN

GTIN 码

The Original Equipment Manufacturer (OEM) can set his own Global Trade Item Number (GTIN).

原始设备制造商 (OEM) 可以设置他自己的全球贸易项目编号 (GTIN)。

DALI Part 251: Memory bank 1 extension.

DALI 第 251 部分: 内存库 1 扩展名。

11.3 Luminaire data

灯具数据

This function provides the asset management with accurate data about the luminaire.

该功能为资产管理提供有关灯具的准确数据。

DALI Part 251: Memory bank 1 extension.

DALI 第 251 部分: 内存库 1 扩展名。

DALI Part 253: Luminaire maintenance data.

DALI 第 253 部分: 灯具维护数据。

11.4 LED current

LED 电流

The LED output current must be adapted to the connected LED module.

LED 输出电流必须适应于所连接的 LED 模块。

The value is limited by the current range of the respective device.

该值受各自设备的当前范围的限制。

The output current of the LED driver can be adjusted in a certain range.

LED 驱动器的输出电流可以在一定的范围内进行调整。

Adjustment is done by KGP Configurator via NFC.

调整是由 KGP 配置器通过 NFC 完成的。

More functions:

更多功能:



Action 操作	Action duration 动作持续时间	Function 功能
Short push 短按	<0.6s	Turn on/off 打开/关闭
Short push five Times 短按 5 次	<3s	Quit Corridor mode 退出走廊模式
Long push 长按	0.6-3s	Dimming up or down 调亮或调暗
Long push 长按	10s	Sync all LEDs to be 50% brightness, and the dimming rate is changed to 3S 同步所有 led 的亮度为 50%，调光渐变时间更改为 3S
Long push 长按	20s	Dimming rate is changed to 6S 调光渐变时间被更改为 6S
Long push 长按	>2mins	Enter Corridor mode - LED keep 100% brightness for 2mins. 进入走廊模式- LED 保持 100%的亮度为 2 分钟。

11.5 Switch DIM

开关 DIM

Integrated Switch DIM function allows a direct connection of a push button for dimming and switching.

集成开关 DIM 功能允许直接连接一个按钮的调光和开关。

Brief push (< 0.6 s) switches LED driver ON and OFF. The dim level is saved at power-down and restored at power-up. When the push button is held, LED modules are dimmed. After repush the LED modules are dimmed in the opposite direction.

短按 (< 0.6 秒) 开关 LED 驱动器 ON 和 OFF。调光级别在断电时保存，在通电时恢复。当按下按钮时，LED 模块变暗。再次按下 LED 模块以相反的方向变化。

In installations with LED drivers with different dimming levels or opposite dimming directions (e.g. after a system extension), all LED drivers can be synchronized to 50 % dimming level by a 10 s push.

在具有不同调光水平或相反调光方向的 LED 驱动器（例如系统扩展后）中，所有 LED 驱动器都可以通过 10 秒的短按同步到 50% 的调光水平。

Use of push button with indicator lamp is not permitted.

不允许使用带指示灯的按键。

11.6 Corridor FUNCTION

走廊功能



With the Corridor FUNCTION and a commercially available motion detector, it is easy to adapt the lighting in one area to its use.

通过走廊功能和商业上可用的运动探测器，它很容易使一个区域的照明适应其使用。

That is, when the area is entered by a person, the lighting dims instantly to the desired brightness and is available in full strength.

也就是说，当有人进入该区域时，照明瞬间变暗到所需的亮度，并可充分使用。

After the area is left by the person, the brightness dims slowly to a smaller value or switches off completely.

当这个人离开这个区域后，亮度会慢慢下降到一个更小的值或完全关闭。

The individual parameters of the desired profile, such as brightness values or delay times, can be adjusted flexibly and individually.

可灵活、单独地调整所需轮廓的各个参数，例如亮度值或延迟时间。

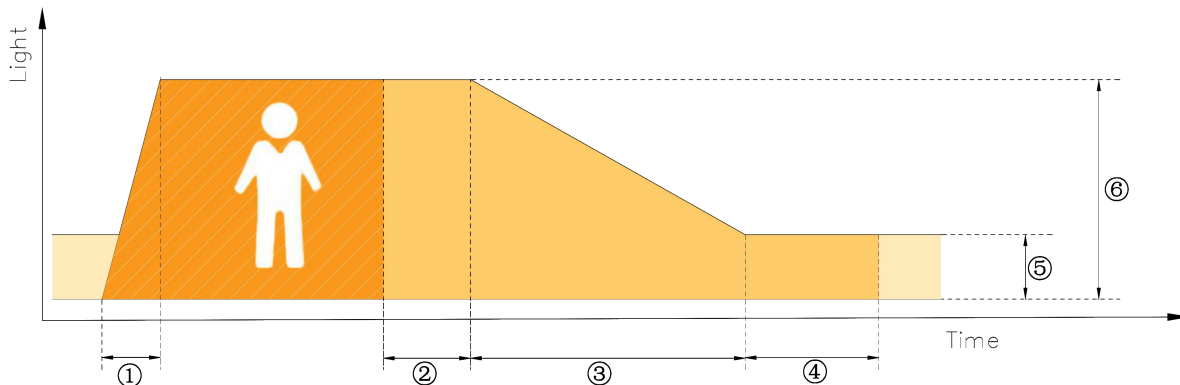

- ① Fade-in time(1s): the time that starts as soon as the presence of a person is detected. During the fade-in time the luminous intensity is faded up to the presence value.
褪色时间（1s）：一旦检测到一个人的存在就开始的时间。在淡出时间内，发光强度减弱到存在值。
- ② Run-on time(120s): the time that starts as soon as the presence of a person is no longer detected. If the presence of a person is detected again during the run-on time the run-on time is restarted from zero. If no presence is detected during the run-on time the fade time is started as soon as the run-on time expires.
运行时间（120秒）：一旦不再检测到一个人的存在，就会开始运行的时间。如果在运行时期间再次检测到人员的存在，则运行时将从零重新启动。如果在运行期间没有检测到存在，则在运行时间过期就开始淡出时间。
- ③ Fade time(32s): the time during which the luminous intensity is faded from the presence value to the absence value.
消失时间（32s）：发光强度从存在值消失到缺失值的时间。
- ④ Switch-off delay (Never Off): the time during which the absence value is held before the lighting is switched off. Depending on the profile selected the switch-off delay may have different values or may not be defined.
关闭延迟（从不关闭）：照明关闭前保持缺失值的时间。根据所选择的配置文件，关闭延迟可能有不同的值，也可能没有被定义。
- ⑤ Absence value(default: 10 %): the luminous intensity when there is no person present.
缺失值（默认值：10%）：没有人在场时的发光强度。
- ⑥ Presence value (default: 100 %): the luminous intensity when persons are present.
存在值（默认值：100%）：人员在场时的发光强度。



11.7 Constant Light Output (CLO)

恒定光输出 (CLO)

With this function the light output of the LED module can be kept equal over the lifetime.

通过这个功能，LED 模块的光输出可以在整个生命周期内保持相等。

The light output of an LED module reduces over the course of its lifetime.

LED 模块的光输出在其生命周期中减少。

The Constant Light Output (CLO) function compensates for this natural decline by constantly increasing the output current of the LED driver throughout its lifetime.

恒定光输出 (CLO) 功能通过不断增加 LED 驱动器的整个生命周期中的输出电流来补偿这种自然下降。

CLO shall be achieved by limitation of the LED current at the commissioning of the LED driver and providing a linear interpolation of the current over the time, depending on the data points given by the user.

CLO 应通过在 LED 驱动器调试时限制 LED 电流，并根据用户给出的数据点提供随时间变化电流的线性插值来实现。

The user has to insert up to eight pairs of data (time, level).

用户最多必须插入 8 对数据 (时间、级别)。

The output curve is the result of connecting the user data points linear.

输出曲线是将用户数据点线性连接的结果。

Detailed description for CLO see product manual.

CLO 的详细说明见产品手册。

The minimal CLO starting point is limited by the smallest output current of the LED driver.

最小 CLO 起始点受到 LED 驱动器的最小输出电流的限制。

11.8 Dimming curve

调光曲线

DALI: The desired dimming behaviour is selected via two different dimming curves (logarithmic or linear).

DALI: 通过两条不同的调光曲线 (对数或线性) 来选择所需的调光行为。

The default setting of the dimming behaviour is logarithmic.

调光行为的默认设置为对数设置。

12. REVISION HISTORY 修订历史

DATE 日期	REV 版本	Modification details 修改内容
2024-12-17	V1.0	Initial release.首次发行

