

Constant Current Driver

Model:C15C100-700N-N



Model	Output Current (*Typical)	Input Current	Input Power	Output Power Range	PF	Efficiency	Output Voltage	No load Voltage
C15C100-700N-N	100mA	0.11A	19W	0.25-4.5W	0.65	75%	2.5-45V	60V
	200mA	0.11A	19W	0.5-9W	0.80	85%	2.5-45V	60V
	300mA	0.11A	19W	0.75-13.5W	0.92	85%	2.5-45V	60V
	400mA	0.11A	19W	1-15.2W	0.92	85%	2.5-38V	60V
	500mA	0.11A	19W	1.25-15W	0.92	85%	2.5-30V	60V
	600mA	0.11A	19W	1.5-15W	0.92	85%	2.5-25V	60V
	700mA	0.11A	19W	1.75-15.4W	0.92	85%	2.5-22V	60V

* Test result @230V, 50Hz, Full Load. Current setting @ 1mA-steps (NFC)

1. Parameters

Category	Item	Technical Norm
Features	Output Type	Constant Current
	Dimming Type	Near field communication (NFC)
	Output Features	Isolation
	IP Grade	IP20
	Insulation Class	Class II
Input	Rated Input Voltage	220-240VAC
	Range of Input Voltage	198-264VAC or 180-280VDC
	Frequency	50/60Hz
	Input Current	≤0.11A (230VAC, full load)
	Input Power	≤19W (230VAC, full load)
	Power Factor	≥0.92 (230VAC, full load)
	THD	≤15% (230VAC, full load)
	Standby power(dim to off)	≤0.5W @230VAC
Output	Output Voltage Range	2.5-45VDC@100-300mA
		2.5-38VDC@400mA
		2.5-30VDC@500mA
		2.5-25VDC@600mA
		2.5-22VDC@700mA
	No Load Voltage	60VDC Max.



	Output Current	100mA -700mA
	Max. Output Power	15.4W
	Efficiency	≥85% (230VAC, full load)
	Current Ripple(< 120 Hz)	±5% (Imax-Imin)/(Imax+Imin)
	PstLM	≤1
	SVM	≤0.4
	Current Accuracy	±5%
	Started Delay Time	≤0.5S(230VAC, full load)
Control Method	NFC current setting	The output current can be set within the total value range in 1-mA-steps. Output current is mean value. Setting is by KGP's software APP/APK/PC with FEIG equipment or mobile phone.
Protection	Short Circuit Protection	Auto Recovery
	Overload Protection	Auto Recovery
	No-load Protection	Auto Recovery
	Insulation voltage	3000V 5mA 60S between P-S
	Insulation resistance	>100M ohm @ 500VDC
	Leakage current	< 250μA, I/P to O/P or I/P to PE @230V input
Environment	Ta/Operation Temperature	-20....+50℃
	Ts/Storage Temperature	-20....+85℃
	Tc/Enclosure Temperature	85℃
	Humidity	10%...90%RH
	Atmosphere	86-108KPa
Construction	Connection Method	Direct Lead
	Installation	Built in
	Dimension	64.5*40*23mm (L*W*H)
Standards	Certification	CE
	Safety Standards	EN 61347-1:2015/A1:2021 EN 61347-2-13:2014/A1:2017 EN IEC 62384:2020 EN 62493:2015
	EMC Standards EMC	EN IEC 55015:2019 EN IEC 55015:2019/A11:2020 EN IEC 61000-3-2:2019/A1:2021 EN 61000-3-3:2013/A2:2021 EN IEC 61547:2023
	Performance	EN62384:2020
	Surge	L-N/1KV
	Others	RoHS
	Life Time	50000h @Ta
	Warranty	5years ,F.R. < 10000ppm
	Noise	≤ 24dB @Background noise ≤18dB , Interval≥15cm
Remark:		



1. All Parameters, if not specified, are measured at 230VAC/50Hz and 25°C ambient temperature.
2. LED Driver is a component of the luminaires, Luminaires and wire layout will affect the EMC, please check the EMC with end products again.

2. Connected quantities of different current Breaker

TYPE	Connected quantities of different current Breaker						Input Voltage	Inrush Current (A)	Time
	current (A)	10	13	16	20	25			
	Installation wire diameter	1.5mm ²	2.5mm ²	2.5mm ²	4mm ²	4mm ²			
TYPE B		24	31	38	48	60	@230VAC	25	200US
TYPE C		38	50	61	77	96			
TYPE D		61	80	98	123	154			

3. Label

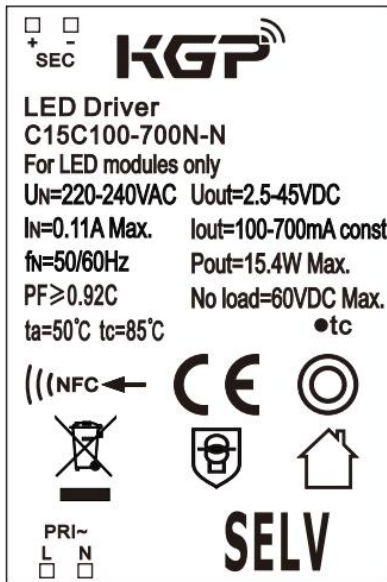

5. Dimension

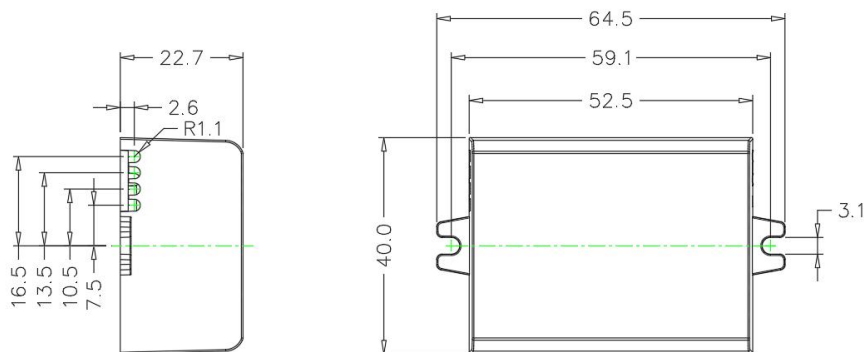

6. Packing information

Packing way	Model	Colour	Carton L*W*H(mm)	Pcs/ Carton	Net weight/ Pcs(kg)	Net weight/ Carton(kg)	Gross weight/ Carton(kg)
industrial	C15C100-700N-N	White	L420*W280*H210	160	0.062	9.92	10.92

7. Wiring Diagram

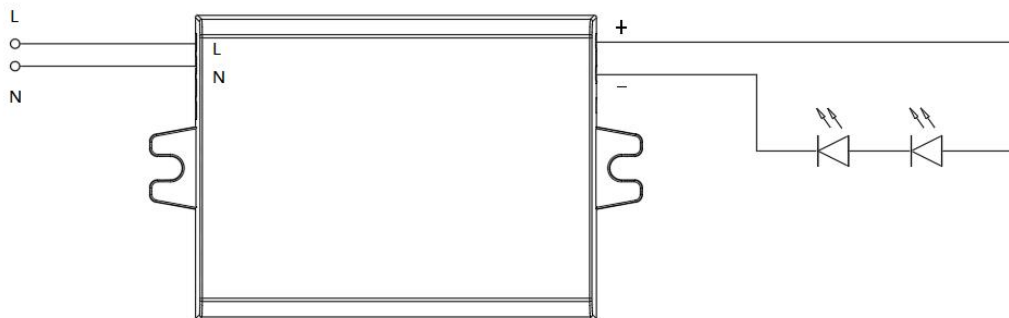

8. Wiring instructions

- All connections must be kept as short as possible to ensure good EMI behaviour
- Mains leads should be kept apart from LED Driver and other leads (ideally 5 – 10 cm distance)
- Advice the maximum length of output wires is 3 m
- Secondary switching is not permitted (Except for constant voltage)
- Incorrect wiring can damage LED modules.
- The wiring must be protected against short circuits to earth (sharp edged metals parts, metal cable clips, louver, etc.)
- Hot plug-in is not supported due to residual output voltage of > 0 V up to mains voltage. Danger to life.
- When connecting an LED load, restart the device to activate the LED output.



9. Replace LED module

- Mains off
- Remove LED module
- Wait for 30 seconds
- Connect LED module again

Hot plug-in or secondary switching of LEDs is not permitted and may cause a very high current to the LEDs

10. NFC instructions

REMARK:





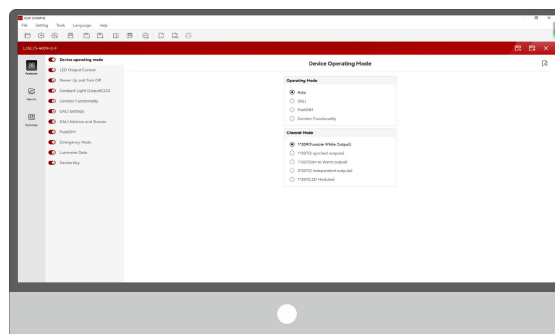

Make sure your computer has NFC capability and has it activated.

NFC Reader (optional)

Feature:

Easily on-line read a output current from a driver or write a new current data to a driver throughout KGP NFC reader within few seconds.



Product	Description	Interface	Matching antenna	Zhaga approval	Usage
 ID CPR30+	Desktop programmer	USB	Integrated	Yes	Single Programming on Desktop
 ID ISC.PRH101-USB	Handheld programmer	USB	Integrated	Yes	Single Programming by Handheld
 ID ISC.MR102-USB	Middle range programmer , for connecting external antenna	USB	RF-MANT12786 	Yes	Single Programming on Product line
 ID ISC.LR1002-E	Long range programmer , for connecting external antenna	USB,RS232,TCP/IP	ID ISC.ANT310/310 	Yes	Multi Programming System



Step 1: Import database file (The ecg database needs to be used only for the first installation)

Click the “Tool” field and select “Import ECG Library” to import the ECG database.

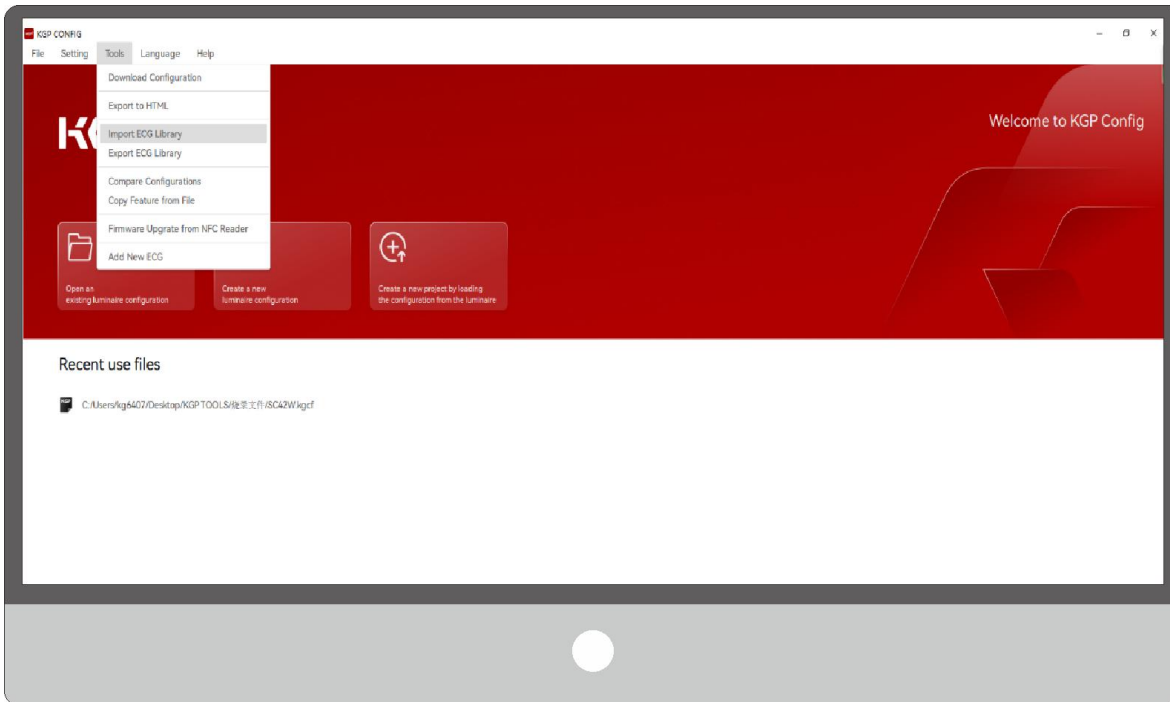

Step 2: Connect FEIG reader

Click the “Setting” button to check whether the NFC port is connected

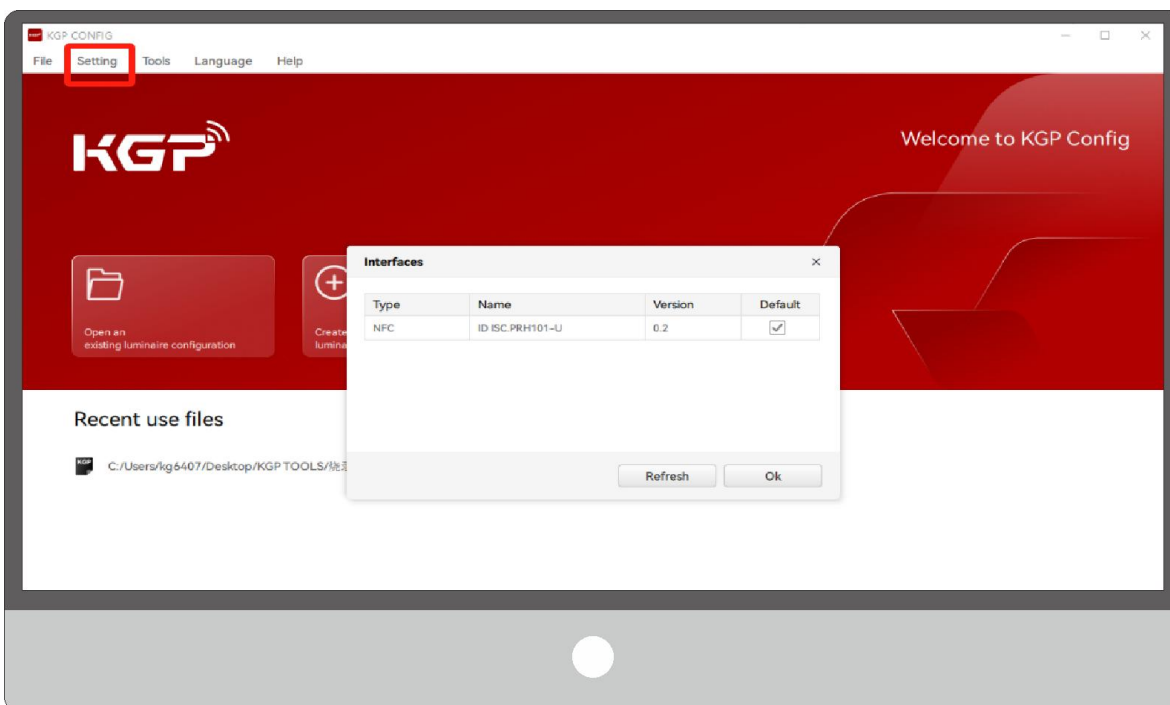

Step 3: Read product information

Click this button to read

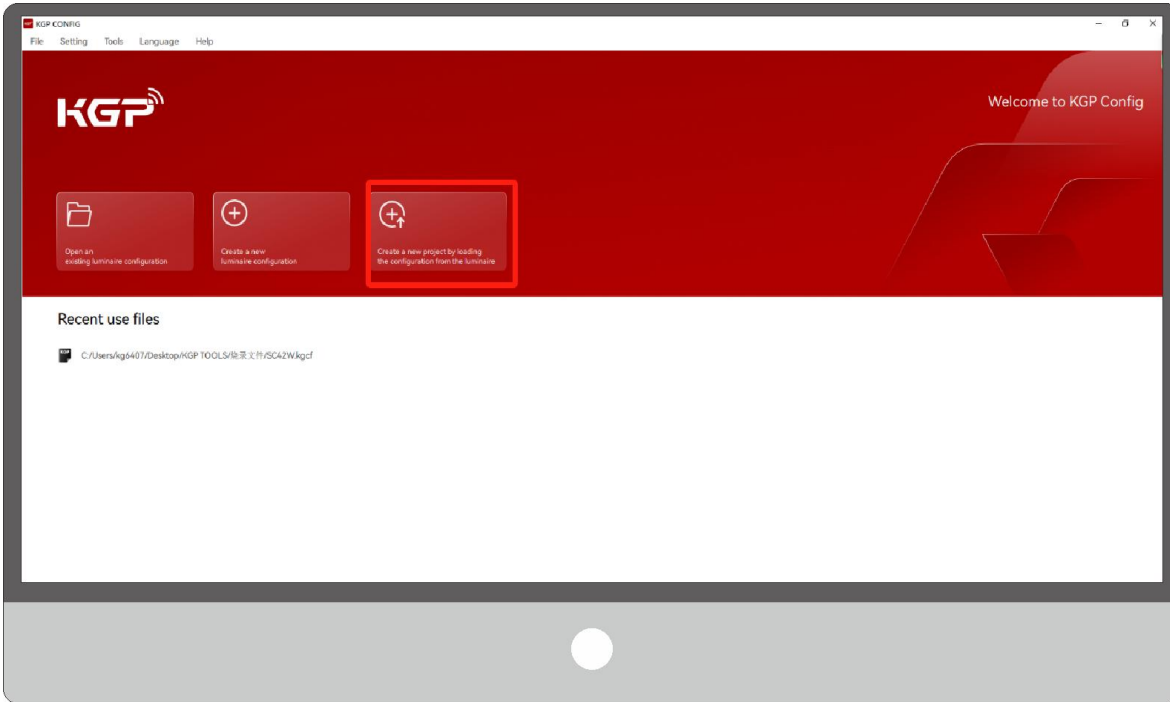

Step 4: You can choose to set the output current according to your needs

Enter the Output current value you want to change in the inputbox

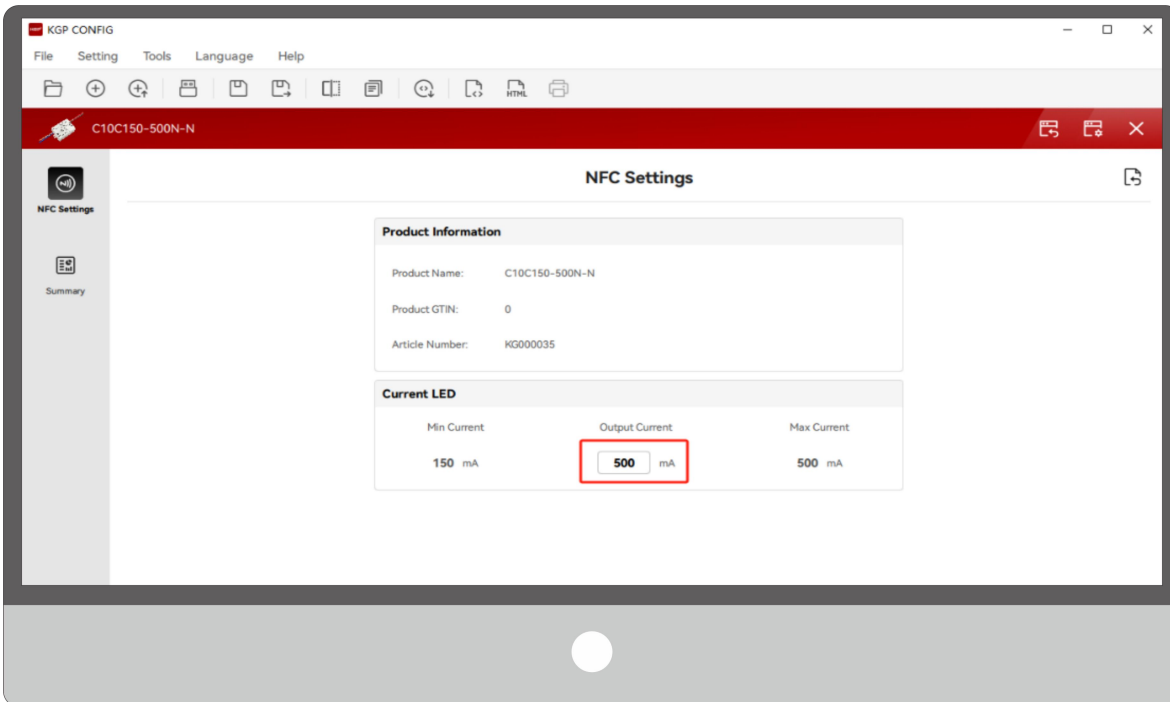

Step 5: After the modification is complete, the download configuration page is displayed

1) Click this button to enter the "Download Configuration" window, select the "User" option box, and click the "Start Programming" button for the next step.

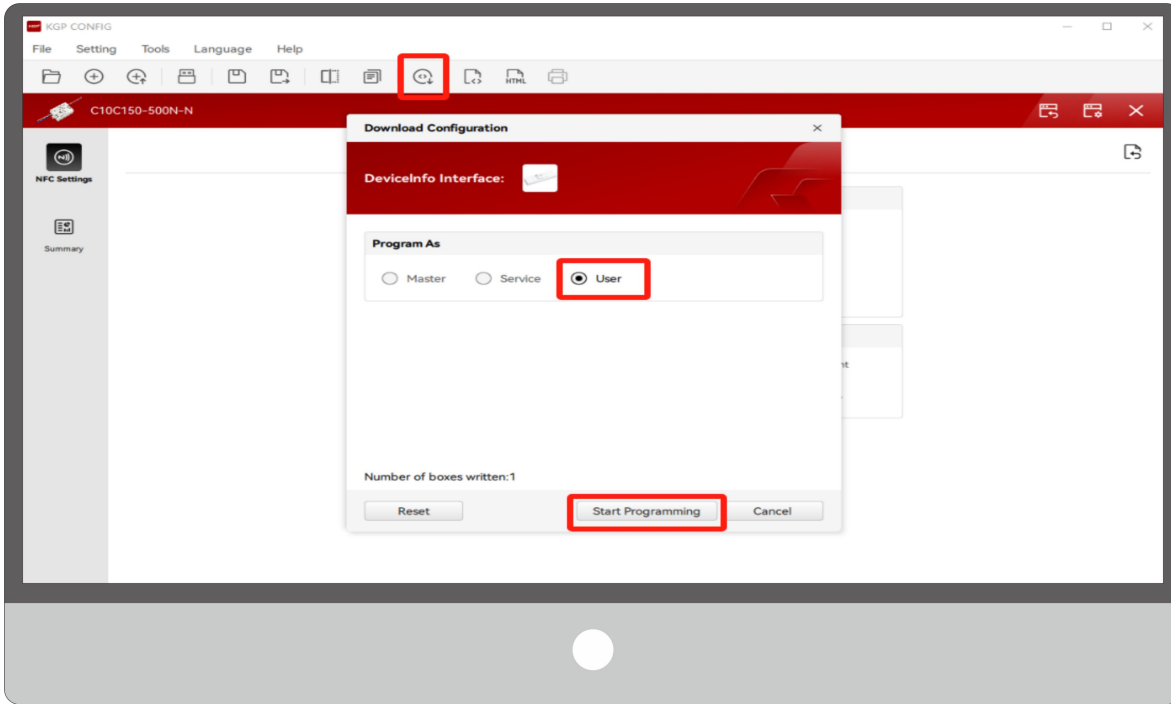

2) Click the "Start" button to program.

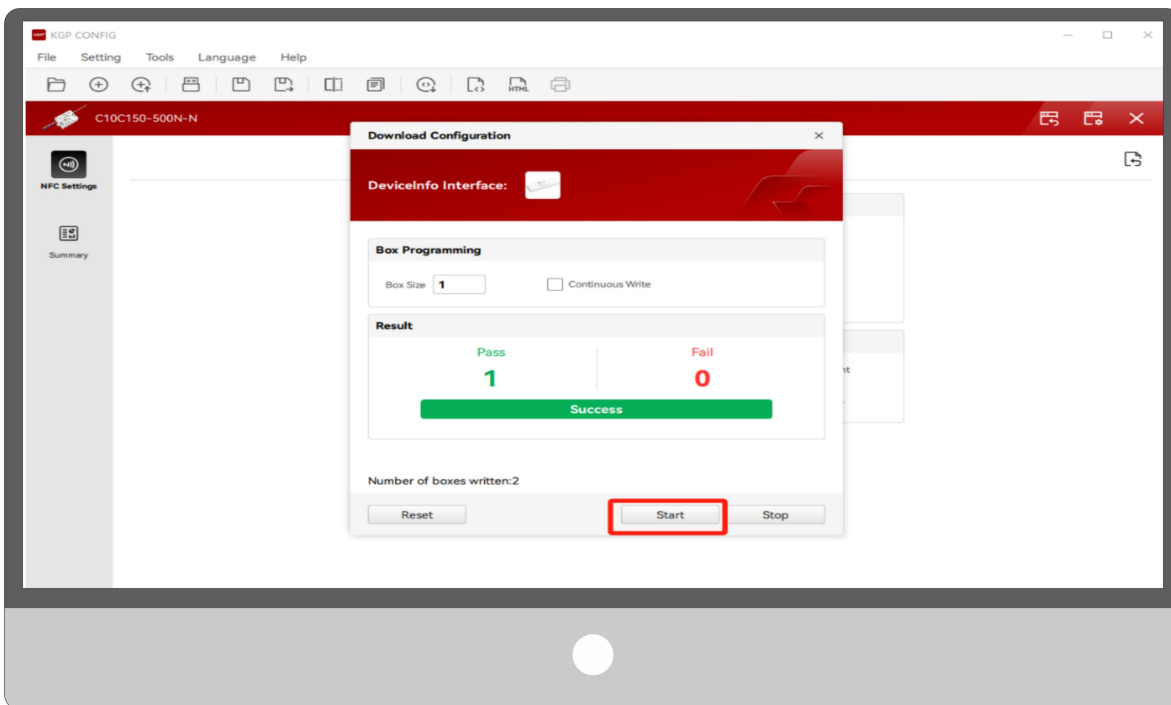

11. mobile client:

Note:

1. Please Make sure that you have enabled NFC function with your mobile phone/ tablet.
2. Please Make sure that the "NFC position" is matched.
3. Please do not power on the device before setting.

Step 1: Download the APP ,then open the APP

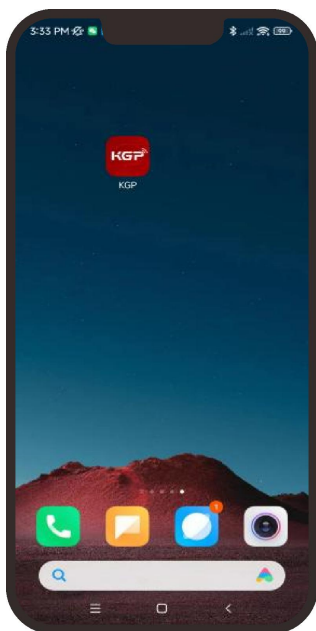

Step 2: Import database file

Click the drop-down box above, select "Import ECG library" ,then import the db database file.

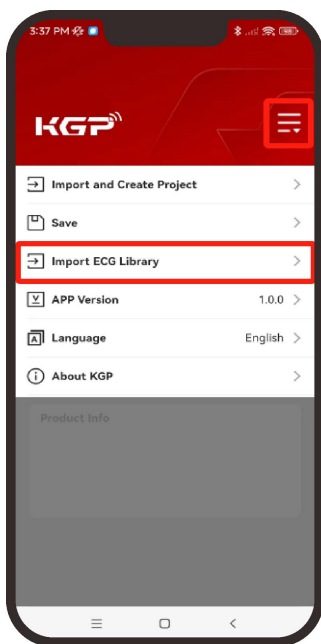

Step 3: Read product information

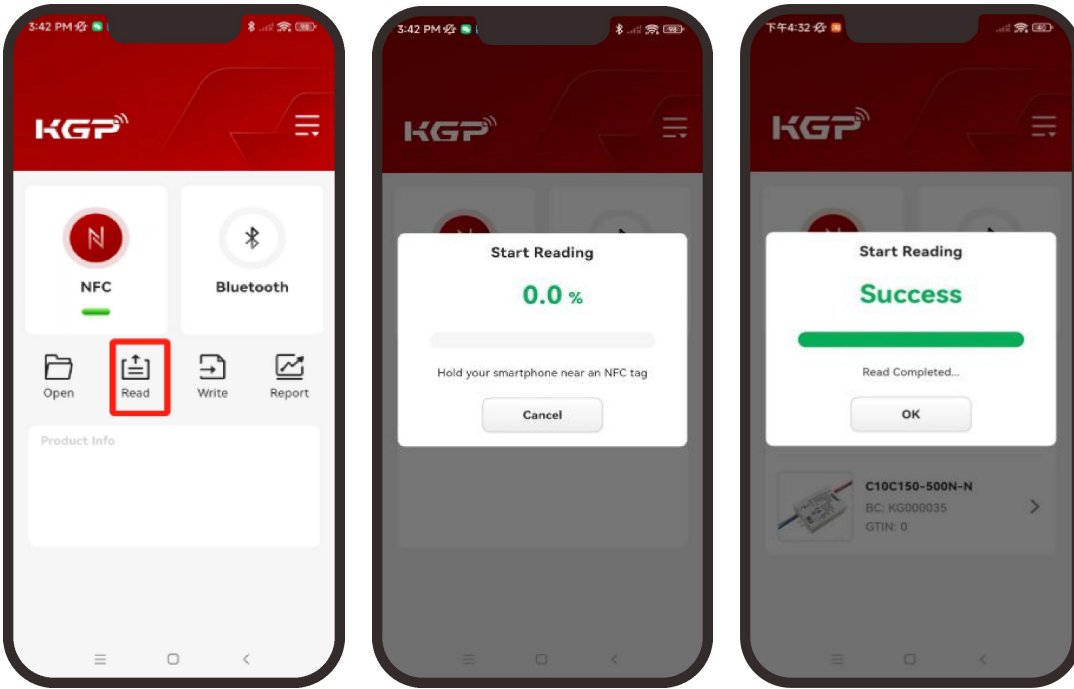

Step 4: You can choose to set the output current according to your needs, then write the configuration, and power on the device

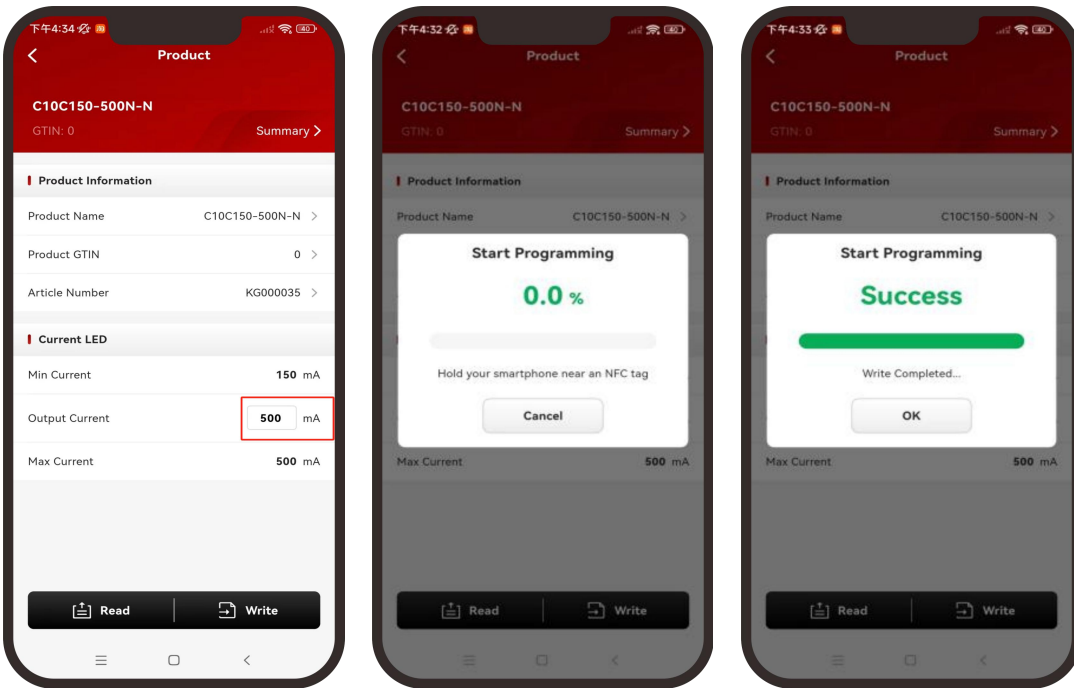

Tips:

1. NFC function doesn't require any power driver.
2. Many functions can be configured by NFC. Kindly check your desired functions.



12. REVISION HISTORY

DATE	REV	Modification details
2024-04-11	V1.0	Initial release.

