



ISO9001 & ISO14001 & TS16949 **CHILISIN ELECTRONICS CORP.**

**Lead-Free & RoHs Compliance!!**

**SPECIFICATION FOR APPROVAL**

**CUSTOMER :** \_\_\_\_\_  
**CUSTOMER P/N :** \_\_\_\_\_  
**OUR DWG No :** \_\_\_\_\_  
**QUANTITY :** \_\_\_\_\_ **Pcs.**    **DATE :**    **2018/9/21**  
**ITEM :**                    **BTCA00702011000G4A**

<b>SPECIFICATION ACCEPTED BY:</b>	
<b>COMPONENT ENGINEER</b>	
<b>ELECTRICAL ENGINEER</b>	
<b>MECHANICAL ENGINEER</b>	
<b>APPROVED</b>	
<b>REJECTED</b>	

<p><b>奇力新電子股份有限公司</b>            Chilisin Electronics Corp            No. 29, Alley 301, Tehhsin Rd.,            Hukou, Hsinchu 303, Taiwan            TEL : +886-3- 599-2646            FAX : +886-3- 599-9176            E-mail : sales@chilisin.com            http : //www.chilisin.com</p>	<p><b>東莞奇力新電子有限公司</b>            Chilisin Electronics (Dongguan) Co., Ltd.            No. 78, Puxing Rd., Yuliangwei Administration            Area, Qingxi Town, Dongguan City,            Guangdong, China            TEL : +86-769-8773-0251~3            FAX : +86-769-8773-0232            E-mail : cect@chilisin.com</p>
<p><b>奇力新電子(河南)有限公司</b>            Chilisin Electronics (Henan) Co., Ltd.            XiuWu Xian, industry gathering area            JiaoZuo, Henan China            Postal Code:454350            TEL:+86-391-717-0682            FAX:+86-391-717-0666</p>	<p><b>蘇州奇益新電子有限公司</b>            SUZHOU QI YIXIN Electronics Co., Ltd.            No.143, Song Shan Rd., Suzhou New District,            Suzhou, China            Postal Code:215129            TEL:+86-512-6841-2350            FAX:+86-512-6841-2356</p>

<b>DRAWN BY</b> 施友程 Robert.Shih	<b>CHECKED BY</b> 施友程 Robert.Shih	<b>APPROVED BY</b> 曲長文 Wen.Chu
------------------------------------	--------------------------------------	-----------------------------------



# Chip Series Specification

**1 Scope: This specification applies to Chip series antenna**

**2 Part Numbering: Product Identification**

B	TCA	□□	7020	□□□□	□□□	A
(1)	(2)	(3)	(4)	(5)	(6)	(7)

- (1)Grade**
- (2)Product Series**
- (3)Control Code**
- (4)Dimensions**
- (5)Internal Code**
- (6)Frequency**
- (7)Version Code**

**3 Rating:**

**Operating Temperature:** -25 °C ~ 125 °C

**Storage Temperature:** 20 °C ~ 25 °C **R.H. 65% (For Referance)**

**4 Marking:**



**5 Standard Testing Condition:**

	Unless otherwise specified	In case of doubt
Humidity	Ordinary Humidity(25 to 85% RH)	60 to 70 % RH
Temperature	Ordinary Temperature(15 to 35°C)	20±2°C

# Chip Series Specification

## 6 Configuration and Dimensions:

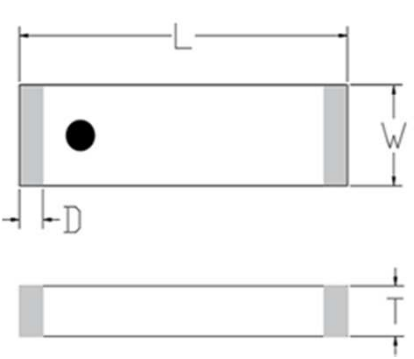
Figure	Dimensions(mm)	
	L	7.0±0.2
	W	2.0±0.2
	D	0.5±0.2
	T	1.1±0.2

### TERMINAL CONFIGURATION



- (1) Feed Termination
- (2) Solder Termination

## 7 Electrical Characteristics:

Part No.	Impedance (Ω)	Test Freq. (MHz)	Bandwidth* (MHz)	Peak Gain* (dBi)	VSWR (max)	Polarization (Linear)
BTCA00702011000G4A	50	433	10	-20.9	2	Linear

NOTE: \*Depend on PCB layout.

# Chip Series Specification

## 8 || Dimensions and Recommended PC Board Pattern:

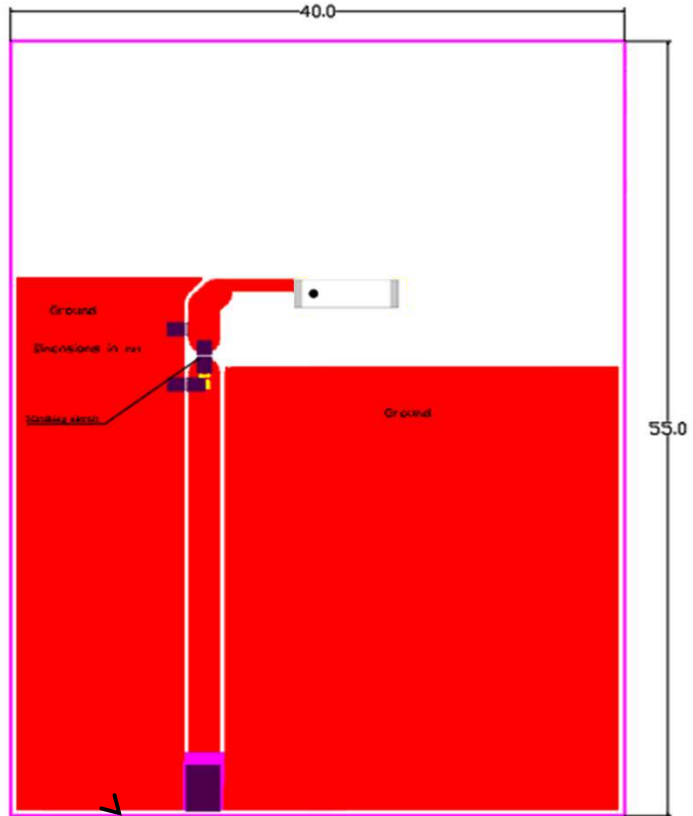

NOTE : Dimensions in mm

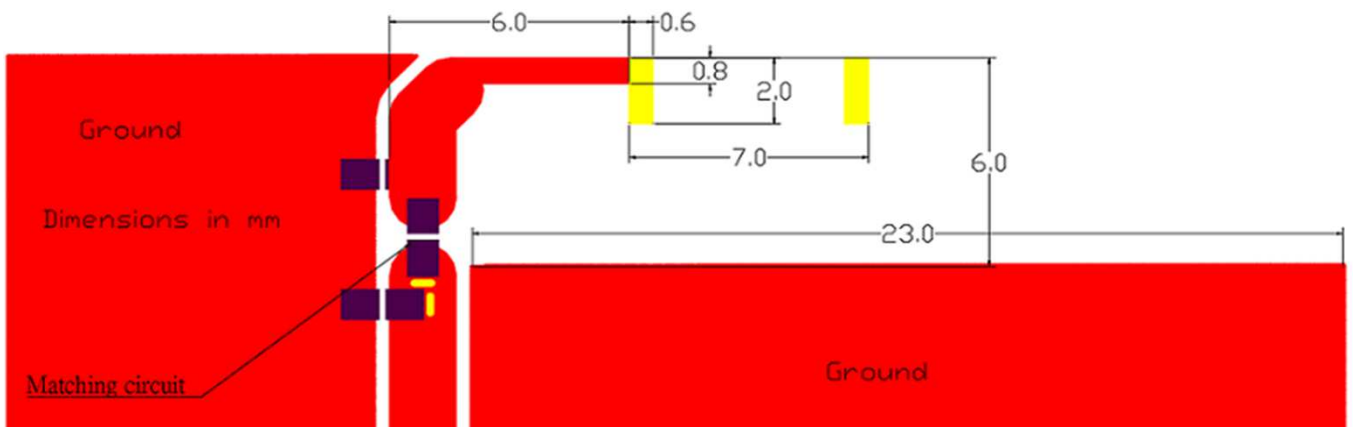

# Chip Series Specification

## 9 Matching Circuit:

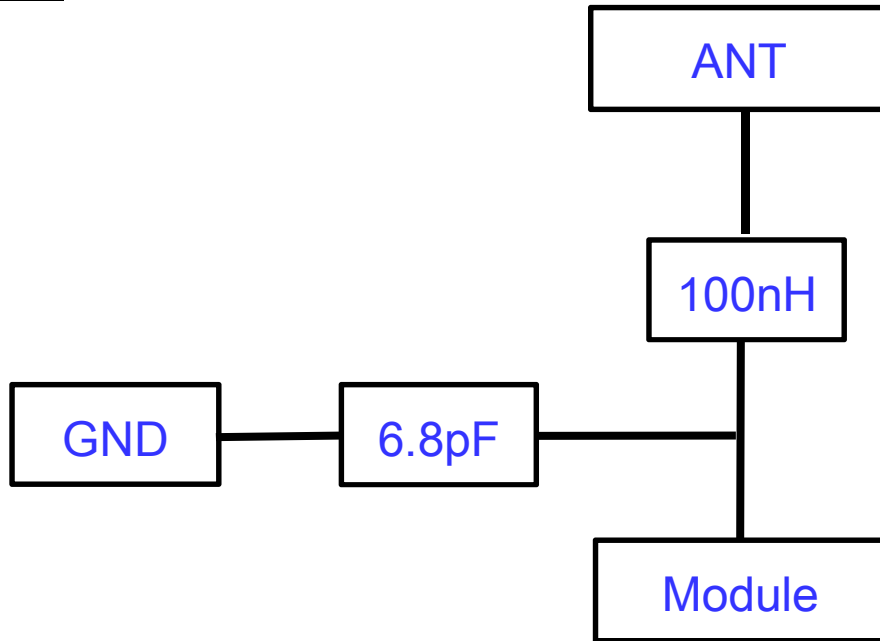

Return Loss

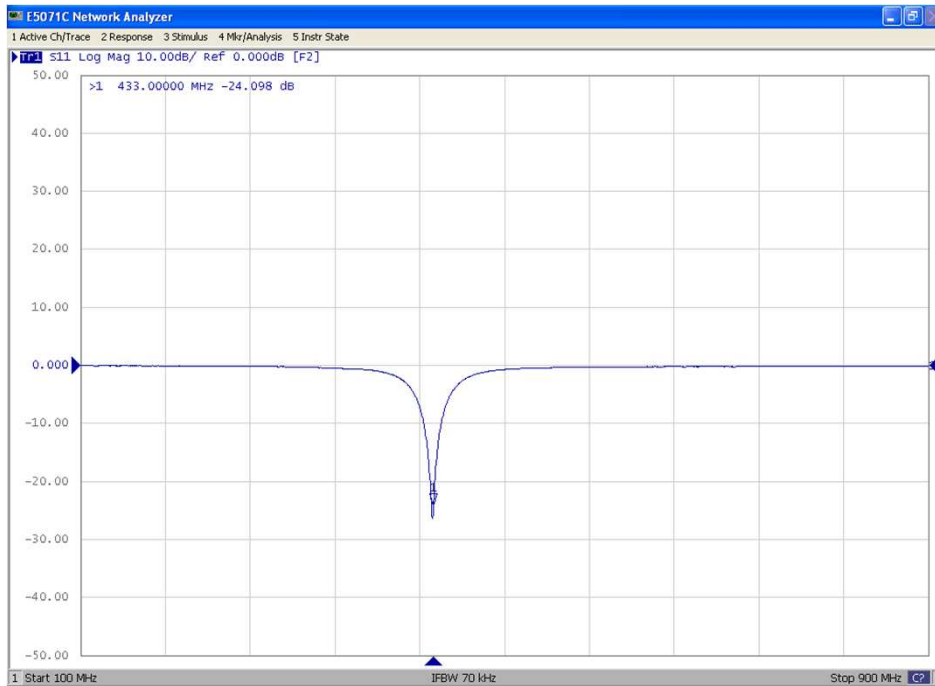

## Chip Series Specification

### 10 Reliability Of Ferrite Multilayer Chip Bead

#### 1-1. Mechanical Performance

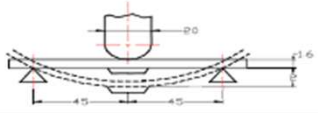
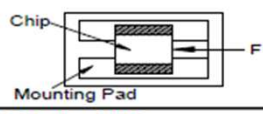
No	Item	Specification	Test Method
1-1-1	Board Flex	The forces applied on the right conditions must not damage the terminal electrode and the ferrite	Test device shall be soldered on the substrate Substrate Dimension: 100x40x1.6mm Deflection: 2.0mm Keeping Time: 60 sec 
1-1-2	Resistance to Soldering Heat	Meet the electrical Specification after test	Refer to MIL-STD-202 Method 210 Pre-heating: 150-200°C, 60-100 sec Above 217°C, 60-150 secs Peak Temperature: 260±5°C, 20-40 sec Cycles : 2 times
1-1-3	Solder ability	The electrodes shall be at least 95% covered with new solder coating	Refer to J-STD-002 Pre-heating: 150°C, 1min Solder Composition: Sn/Ag3.0/Cu0.5(Pb-Free) Solder Temperature: 245±5°C (Pb-Free) Immersion Time: 4±1sec
1-1-4	Terminal Strength Test	The chip must not damage the terminal electrode and the ferrite	Test device shall be soldered on the substrate Force 2N for 60±1 seconds for 0603 series Force 5N for 60±1 seconds for 1005 series Force 10N for 60±1 seconds for 1608 series Force 1.8Kg for 60±1 seconds for the other series. 
1-1-5	Vibration Test	Meet the electrical Specification after test	Refer to MIL-STD-202 Method 204 Vbration waveform: Sine waveform Vibration frequency: 10Hz~2000Hz Vibration acceleration: 5g 10Hz~20KHz and back to 10Hz should be down in 20 minutes Duration of test: 12 cycles each of 3 orientations, 20 minutes for each cycle, 12 hr total Vibration axes: X, Y & Z
1-1-6	Resistance to Solvent	There must be no change in appearance or obliteration of marking	Refer to MIL-STD-202 Method 215 Inductors must withstand 6 minutes of alcohol or water.



# Chip Series Specification

## 10 Reliability Of Ferrite Multilayer Chip Bead

### 1-2.Environmental Performance

No	Item	Specification	Test Method
1-2-1	Temperature Cycle	Meet the electrical Specification after test	Refer to JESD Method JA-104 Total cycles: 1000 cycles 30 minutes exposure to -40°C 30 minutes exposure to 125°C 1 min. maximum transition between temperatures  Measured after exposure in the room condition for 24hrs
1-2-2	Biased Humidity Resistance		Refer to MIL-STD-202 Method 103 Temperature: 85±2°C Relative Humidity:85% / Time: 1000hrs  Measured after exposure in the room condition for 24hrs
1-2-3	High Temperature Exposure (Storage)		Refer to MIL-STD-202 Method 108 Temperature: 125±3°C / Relative Humidity: 0% Time: 1000hrs  Measured after exposure in the room condition for 24hrs
1-2-4	Low Temperature Exposure (Storage)	Meet the electrical Specification after test	Refer to MIL-STD-202 Method 108 Temperature: -40±3°C / Relative Humidity : 0% Applied Current: Rated Current/ Time: 1000hrs  Measured after exposure in the room condition for 24 hrs

## Chip Series Specification

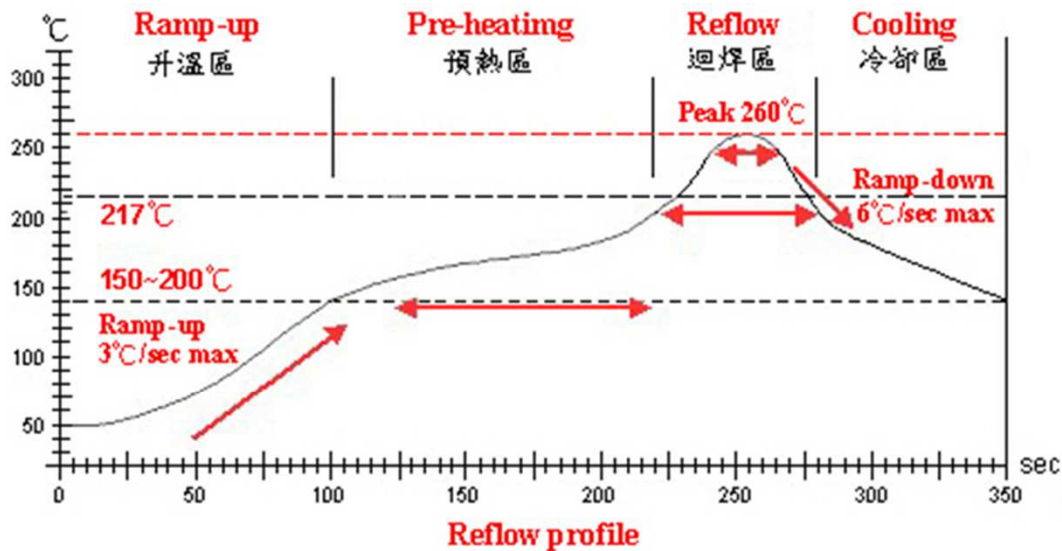

Lead-Free(LF) 標準溫度分析範圍

Refer to J-STD-020C

管制項目 Item.	升溫區 Ramp-up	預熱區 Pre-heating	迴焊區 Reflow	Peak Temp	冷卻區 Cooling
溫度範圍 Temp.scope	R.T. ~ 150°C	150°C ~ 200°C	217°C	260±5°C	Peak Temp. ~ 150°C
標準時間 Time spec.	—	60 ~ 180 sec	60 ~ 150sec	20 ~ 40 sec	—
實際時間 Time result	—	75 ~ 100 sec	90 ~ 120sec	20 ~ 35 sec	—

NOTE :

1. Re-flow possible times : within 2 times
2. Nitrogen adopted is recommended while in re-flow