

未注公差/General tolerances(mm)											0.1/10 ±2'		
0	>3	>6	>10	>18	>30	>50	>80	>120	>180	>250			
~3	~6	~10	~18	~30	~50	~80	~120	~180	~250	~315	~400	~500	>500
±0.12	±0.18	±0.22	±0.26	±0.31	±0.37	±0.57	±0.80	±0.93	±1.05	±1.15	±1.60	±2.20	±2.50

A

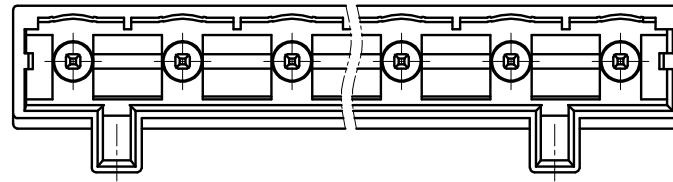

B

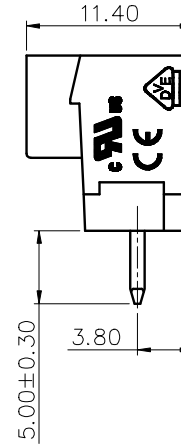
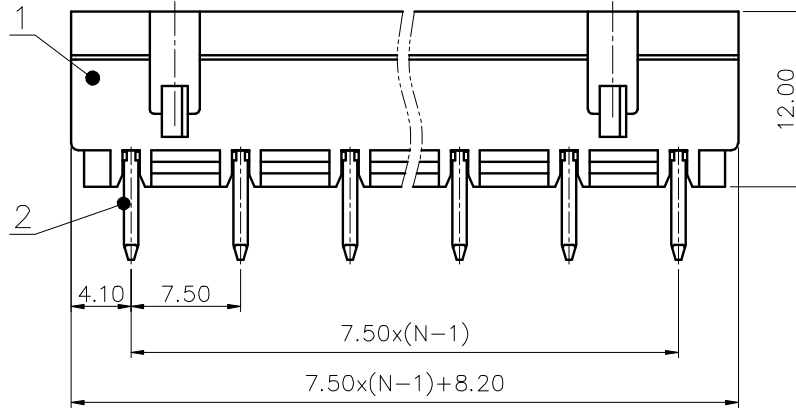
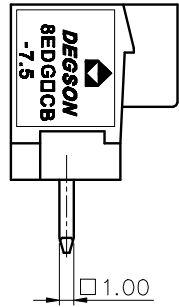

C

PCB LAYOUT

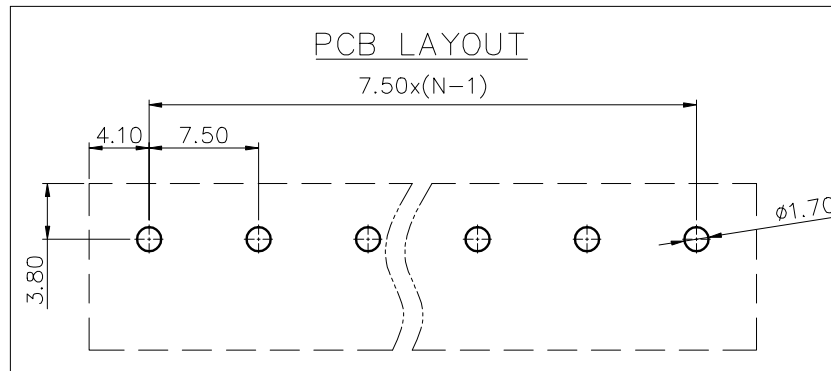

D

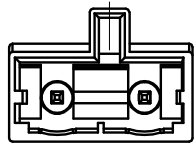

02P

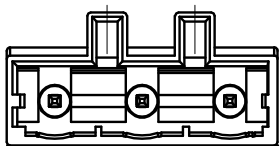

03P

ITEM	NAME OF PART	MATERIAL	NOTES
2	Pin	Copper	Sn Plated
1	Housing	PA66	UL94V-0
UL 标准/UL Standard:		B	C D
额定电压/电流/Rated Voltage(V)/Current(A)		300/15	/ 300/10
IEC 标准/IEC Standard:			
过压类别/Overvoltage Category/污染等级/Pollution Degree		III/3	/ /
额定电压/电流/Rated Voltage(V)/Current(A)		400/20	/ /
额定脉冲电压(KV)/Rate Impulse Voltage(KV)		4	/ /
间距/Pitch(mm)/线数范围/Poles		7.50/N=02~12P	
使用温度范围/Operating temperature(°C)		-40~+105	
符合RoHS环保要求/Conform to RoHS		Yes	
标准颜色编号/Standard color number: PANTONE / RAL		PANTONE 7534U	

MATERIAL: /	SURFACE: /		
MAT NO.: /	宁波高松电子有限公司 NINGBO DEGSON ELECTRICAL CO., LTD		
STATUS: /			
APPD:			
CHKD:			
DRFT: CenX 2020.06.02	NAME: 8EDGVCB-7.5-XXP-11-01A(H)	DRAWING NO.: 8EDGVCB-7.5-C01	REV TO
⊕	SIZE: A4	TYPE: CUSTOMER DRAWING	SCALE: 2:1 SHEET 1/1

REV	ECN	DESCRIPTION	DRFT	DATE