

A

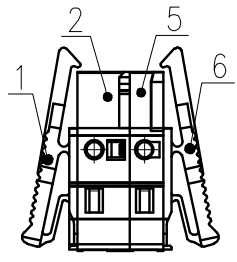

02P

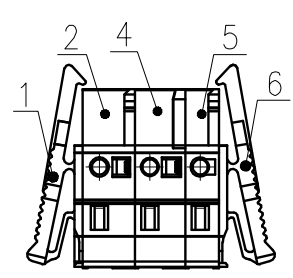

03P

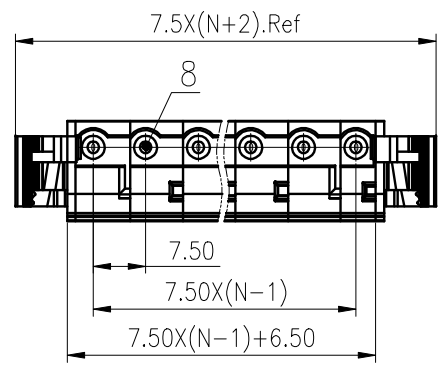

B

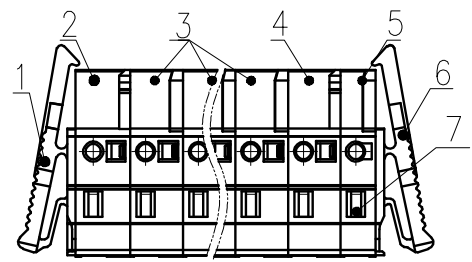
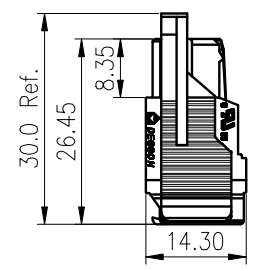

C

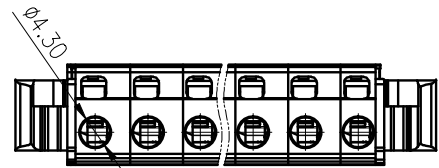

D

Pitch Range In mm			Nominal Dimension Range In mm					
TO	Over	Over	TO	Over	Over	Over	0.1/10	
6	10	10	30	30	60	100		
6	10	24	30	60	100	150	±0.15 ±0.20 ±0.30 ±0.30 ±0.50 ±0.70 ±1.00 ±1.30 ±2'	

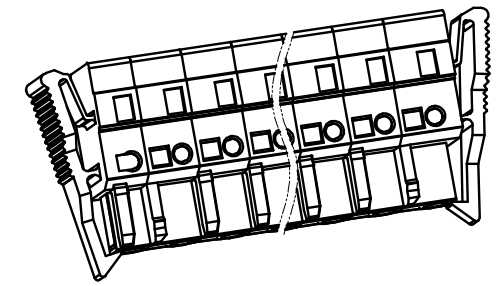

ITEM	NAME OF PART	MATERIAL	NOTES
8	Clamp	Copper alloy	Sn Plated
7	Spring	Stainless Steel	
6	Cover 2	PA66	UL94V-0
5	Side Housing 2	PA66	UL94V-0
4	Middle Housing 2	PA66	UL94V-0
3	Middle Housing 1	PA66	UL94V-0
2	Side Housing 1	PA66	UL94V-0
1	Cover 1	PA66	UL94V-0

UL 标准/UL Standard:	B	C	D
额定电压/电流/Rated Voltage(V)/Current(A)	300/15	300/15	/
IEC 标准/IEC Standard:			
过压类别/Overvoltage Category/污染等级/Pollution Degree	III/3	III/2	II/2
额定电压/电流/Rated Voltage(V)/Current(A)	400/20	/	/
额定脉冲电压(kV)/Rate Impulse Voltage(kV)	4	/	/
线径范围(硬线和软线)/Wire Range(rigid and flexible)(mm ² /AWG)	0.2~2.5/22~14		
间距/Pitch(mm)/线数范围/Poles	7.5/N=02~12P		
剥线长度/Stripping length(mm)	9~10		
使用温度范围/Operating temperature(°C)	-40~+105		
符合RoHS环保要求/Conform to RoHS	Yes		
标准颜色编号/Standard color number:	PANTONE 428C		

MATERIAL: /	SURFACE: /		
MAT NO.: /	宁波高松电子有限公司 NINGBO DEGSON ELECTRICAL CO., LTD		
STATUS: /			
APPD:			
CHKD:			
DRFT: XieZhP 2020.06.17	NAME: 8EDGKGB-7.5-XXP-11-1001A(H)	DRAWING No.: 8EDGKGB-7.5-1000-C02	REV TO
⊕	SIZE: A4	TYPE: CUSTOMER DRAWING	SCALE: 1:1 SHEET 1/1

REV	ECN	DESCRIPTION	DRFT	DATE