

REVISION RECORD				
REV	ECN	DESCRIPTION	DRFT	DATE

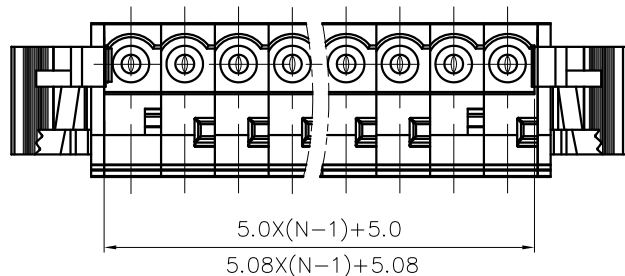

NOTES1:

UL Standard

1. Rated voltage/current : 300V / 15A
2. Withstanding voltage : AC1600V/1Min.
3. Wire range : 22~14AWG

IEC Standard

1. Pollution Degree	3
Overvoltage Category	III
Rate Impulse Voltage(KV)	4.0KV
Rate Voltage(V)	320V
Rate Current(A)	20A

2. Wire range : 0.2~2.5mm²

NOTES2:

1. Dimension shall be interpreted per ASME Y14.5-2009
2. Pitch : 5.0/5.08mm, Poles : N=02~24P
3. Stripping length : 8~9mm
4. Operating temperature: -40°C~+105°C
5. Undimensioned tolerances:

Pitch range in mm		Nominal dimension range in mm					—	∩	∠
TO 6	Over 6 TO 10	Over 10 TO 24	Over 30 TO 60	Over 60 TO 100	Over 100 TO 150	Over 150	0.1/10		
±0.15	±0.20	±0.30	±0.30	±0.50	±0.70	±1.00	±1.30	±2'	

6. RoHS Compliance

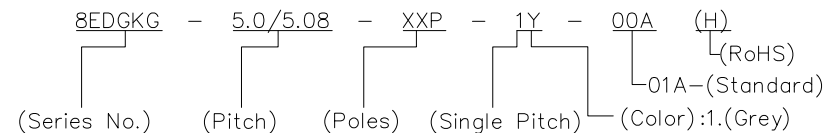

- (RoHS)
01A-(Standard)
1.(Grey)
2.(Blue)
3.(Black)
4.(Green)
5.(Orange)
6.(Red)
7.(Transparent)
8.(Yellow)
9.(White)

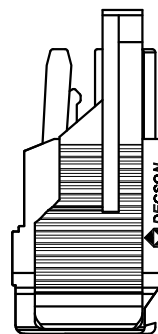
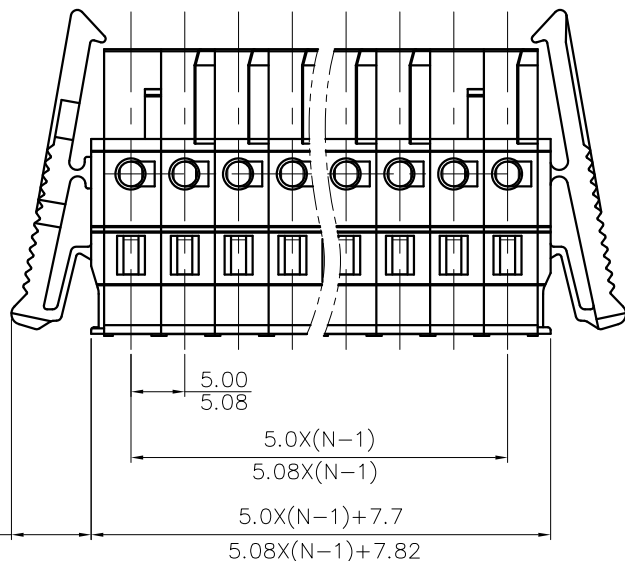
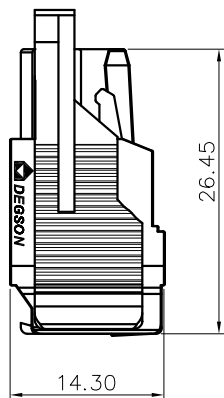

7.4 Ref.

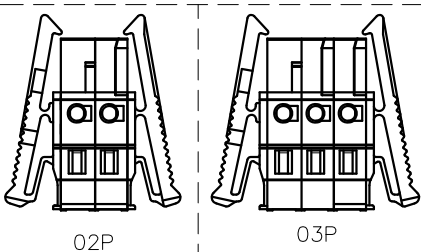
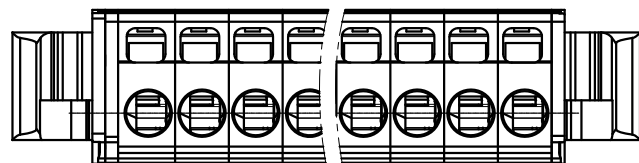

DETACHED LISTS	PART NO.:	/		
	APPD:	/		
	CHKD:	/		
	DRFT:	/		
	NAME:	NINGBO DEGSON ELECTRICAL CO., LTD		
		8EDGKG-5.0/5.08-XXP-1Y-00A(H)		
	TITLE:	CUSTOMER DRAWING	REV	D0
	DRAWING NO.:	/	SHEET	1/1
	THIRD ANGLE PROJECTION	MM (INCH)	DO NOT SCALE DRAWING	SCALE 1:1