

REVISION RECORD

REV	ECN	DESCRIPTION	DRFT	DATE
△1	10-0336	增加“VDE”、“CE”认证标志	Jnhai.Lan	09/16/10
△2	10-0399	图面错误, 修改图面	Goledn	12/06/10
△3	11-0180	更新图面	zxx	07/12/11
△4	12-0230	进线孔加胶及更新图面	JEX	11/01/12
△5	15-0077	修订技术参数	GYZ	02/28/15

- NOTES:
- 1.DIMENSION SHALL BE INTERPRETED PER ASME Y14.5-2009.
 - 2.PITCH: 3.5MM ,POLES: 2-24P
 - △ 3.RATED VOLTAGE/CURRENT: UL 300V/10A
VDE 130V/10A
 - 4.OPERATION TEMPERATURES: -40℃~+105℃
 - △ 5.RATED IMPULSE VOLTAGE: 2.5KV
 - 6.WIRE RANGE: 28~14AWG, 0.2~1.5MM²
 - 7.UNDIMENSIONED TOLERANCES:

PITCH RANGE IN MM		NOMINAL DIMENSION RANGE IN MM					-		
TO 6	OVER 6 TO 10	OVER 10 TO 24	TO 30	OVER 30 TO 60	OVER 60 TO 100	OVER 100 TO 150	○		
	±0.10	±0.15	±0.25	±0.20	±0.30	±0.50	±0.70	±1.00	0.05/10

文管中心
 研发专用
 2015.08.07
 (仅限内部使用, 对外无效)

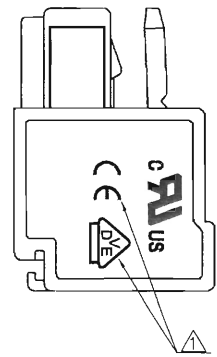

VIEW A-A

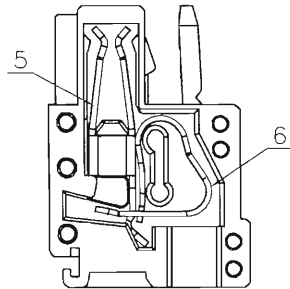
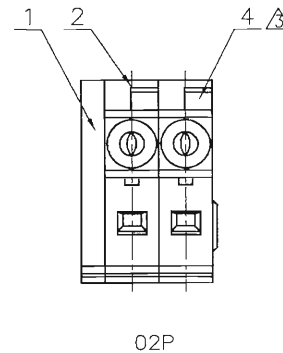
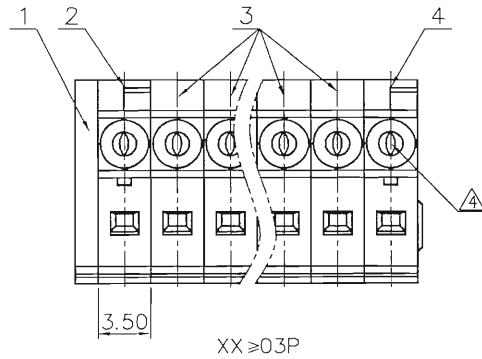

TAKE OFF COVER VIEW

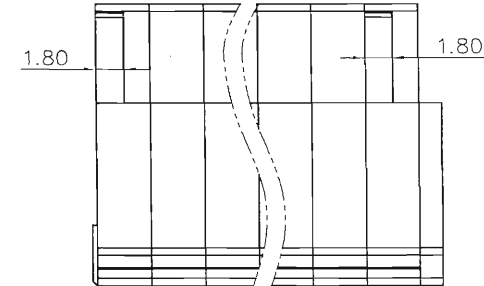
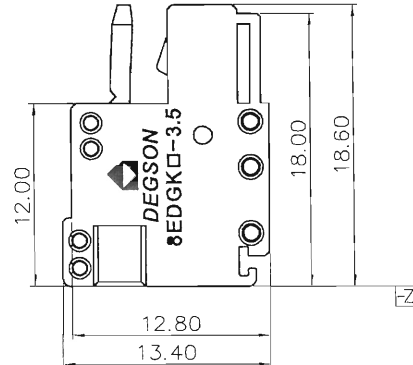
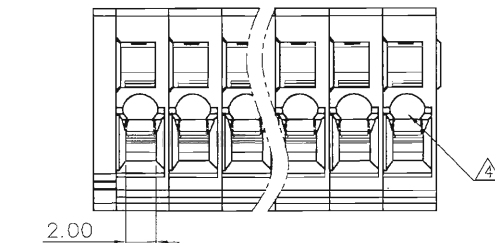
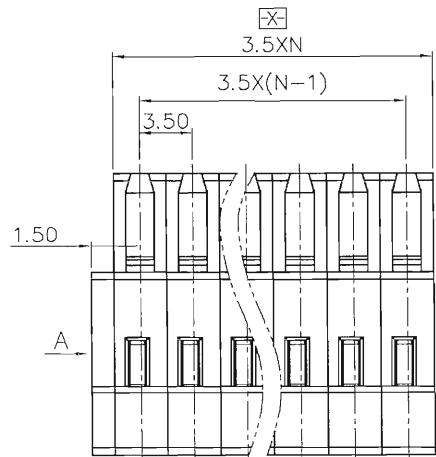

ITEM	NAME OF PART	NO. OF PART	Q"TY	MATERIAL	NOTES
2	8EDGK-3.5-Side Housing-1	1117A4101D(H)	1	PA66	UL94V-0
1	8EDGK-3.5-COVER	1117C4101A(H)	1	PA66	UL94V-0

NO.	DESCRIPTION	ITEM NO.	QTY	MATERIAL	REMARKS
6	WS 1.5--SPRING	X000001700(H)	XX	Stainless steel	
5	8EDGK-3.5--CLAMP	1117B00010(H)	XX	Phosphor Bronze	Sn plated
4	8EDGK-3.5-Side Housing-2	1117A4101C(H)	△ 1	PA66	UL94V-0
3	8EDGK-3.5-Housing	1117A4101A(H)	△ XX-2	PA66	UL94V-0

DEGSON 宁波高正电子有限公司
 DEGSON ELECTRONICS CO., LTD

NAME: 8EDGK-3.5-XXP-11-01A(H)

TITLE: ASSEMBLY DRAWING
 DRAWING NO.: 8EDGK-3.5-E01
 REV: 5

DRFT: LJK 12/20/06

DO NOT SCALE DRAWING SCALE N/A SHEET 1/1

H
G
F
E
D
C
B
A

G
F
E
D
C
B
A