

REVISION RECORD

REV	ECN	DESCRIPTION	DRFT	DATE
-----	-----	-------------	------	------

H
G
F
E
D
C
B
A

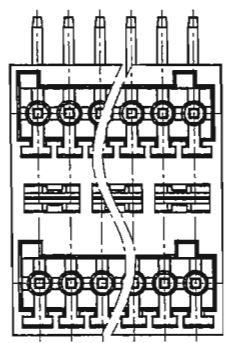
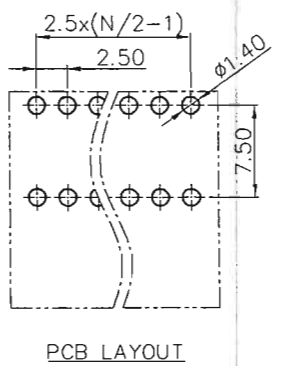
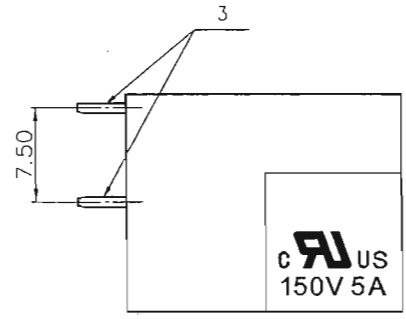
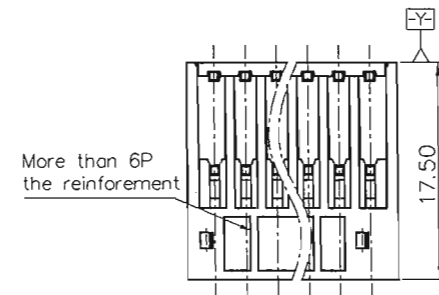
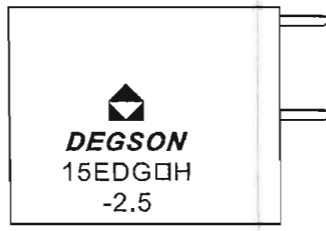
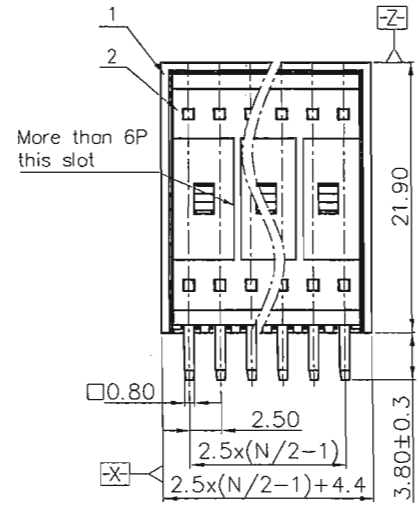
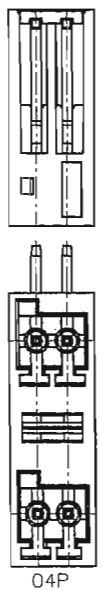

NOTES1:

- UL Standard
- 1. Rated Voltage/Current : 150V / 5A
- 2. Withstanding Voltage : AC1300V/1Min.

IEC Standard

1. Pollution Degree	2
Overvoltage Category	II
Rate Impulse Voltage(KV)	2.5KV
Rate Voltage(V)	100V
Rate Current(A)	4A

NOTES2:

- 1. Dimension shall be interpreted per ASME Y14.5-2009
- 2. Pitch : 2.5mm, Poles : N=4~24P
- 3. Operating temperature: -40°C~+105°C
- 4. Undimensioned Tolerances

Pitch Range In mm		Nominal Dimension Range in mm					±	∠	∅
TO	Over TO	Over TO	TO	Over TO	Over TO	Over TO	0.1/10	<	
6	10	10	30	60	100	150			
6	10	24	30	60	100	150			
±0.15	±0.20	±0.30	±0.30	±0.50	±0.70	±1.00	±1.30	±2'	

- 5. The degree of deformation control:
04-12P: ≤0.35mm
14-18P: ≤0.45mm
20-24P: ≤0.50mm
- 6. RoHS Compliance



3.	PIN	COPPER ALLOY	Sn Plated
2.	COVER	PA66	UL94V-0
1.	HOUSING	PA66	UL94V-0
ITEM	NAME OF PART	MATERIAL	NOTES

PART NO.:		宁波高松电子有限公司	
APPD: <i>Alom 10/09/15</i>		DEGSON ® NINGBO DEGSON ELECTRICAL CO., LTD	
CHKD: <i>xl m 10/8/15</i>		NAME: 15EDGRH-2.5-XXP-1Y-00A(H)	
DRFT: LIN 08/09/07		TITLE: CUSTOMER DRAWING	REV TO
THIRD ANGLE PROJECTION		DRAWING NO.: 15EDGRH-2.5-C01	SHEET 1/1
		MM (INCH)	DO NOT SCALE DRAWING SCALE 1:1